



# 2024 RESEARCH SUMMARY

## Table of Contents

Introduction and Guide to Summary Report	4
Top 10 and Bottom 10 ROI Performers	6
Corn Summary of 2024 FurrowJet® Applications	134
Corn Summary of 2024 Conceal® Applications	148
Soybeans Table of Contents	178
Soybeans Summary of 2024 FurrowJet® & Conceal® Application	253
Wrap Up	271
Acknowledgments and Legal Statement	272

### CORN

#### **Corn Planting Principles:**

Planting Date	7
Starter Fertilizer Response by Date	8-9
vSet® Planter Singulation	10
SmartDepth® Planting Depth	11-13
Reveal® Residue Management	14-15
CleanSweep® Residue Management	16-17
Multi-Year Day of Emergence	18
High Speed Planting	19
SeedTube Planting	20
FurrowForce®	21-22
Closing Wheel/Tillage	23-27
Downforce Management	28-30
Planter "All-Wrong"	31
Fendt® Momentum™ Weight Management	32
Traffic Management	33
Multi-Genetic Planting	34-35
Seed Orientation	36-37
Leaf Orientation	38
15" Row Corn Seeding Rate	39
20" Row Corn Seeding Rate	40
Multi-Year Narrow Row Corn	41
15" Row Corn Nitrogen Placement	42-43
Fall Strip-Till/Urea Nitrogen	44-45
Short Corn 30" Seeding Rate	46-47
Short Corn Row Width/Seeding Rate	48-49
REVLIN® HOPPER THROTTLE™	50
New Fields Ag™ Bio Stealth	51
SpeedWet Xion SiliconGel®	52
Green Lightning PAW Seed Treatment	53
HyperSound Technology Seed Treatment	54
SIMPAS® Soil Insecticide/Seed Trait	114-115
Nurizma™ Soil Insecticide/Seed Trait	116-117
Nurizma™ Soil Applied Insecticide	118
PLINAZOLIN® Technology SC300	119
Solar Corridor	151

#### **Corn Dry Fertilizer Studies:**

Broadcast vs Banding	55-57
Broadcast vs Banding Rate Efficiency	58-60
Mosaic® Sulfur/Boron Dry Fertilizer	61-62
Liquid vs Dry Fall Strip Till	63-65
Calcium Products 98G™	66
Smart Hydrogel Soil Retainer	67-68

#### **Corn Nitrogen Programs:**

Pivot Bio PROVEN40® Nitrogen Mgt.	106-107
Pivot Bio On-Seed	108-109
Envita® Nitrogen Mgt.	110-111
NanoCOTE™ Urea Treatment	112-113
Green Lightning PAW	122-123
Single, Double, Triple N Timing	135
Nitrogen Sealer	139
Urea vs UAN	140-143

#### **Corn FurrowJet® Programs:**

Marco QuickGrow™ LTE FurrowJet®	104
Nachurs® impulse® FurrowJet®	105
Green Lightning PAW FurrowJet®	120-121
Aqua-Yield® NanoCS®	124-125
Pritchard Ag LLC	126
AgroLiquid® Micro 500®	127
AgroLiquid® LiberateCa™	128
Ethos® Elite In-Furrow	129
Xyway® LFR® FurrowJet®	130-131
Capture® LFR®	132
FurrowJet® Nitrogen	133

#### **Corn Cover Crop Studies:**

Continuous Corn Cover Crop	149
Corn after Soybean Cover Crop	150

#### **Corn Conceal® Programs:**

Single vs. Dual Band Conceal® Nitrogen	136
Multi-Yr At-Plant Nitrogen Placement	137-138
Conceal® K-Fuse® Potassium	144
Aqua-Yield® Nano N+®	145-146
AgroLiquid® eNhance	147

## **Corn Foliar Programs:**

Green Lightning PAW Foliar	152-153
Veltyma® Foliar Fungicide	154
Adastrio™ Foliar Fungicide	155
Miravis® Neo Foliar Fungicide	156
Veltyma® Foliar Fungicide	157-158
Ground vs. UAV Foliar Application	157-160
Aqua-Yield® NanoK®	161-162
Aqua-Yield® NanoPro®	163

## **Corn Harvest Studies:**

Chopping Corn Head	164
Phantom Yield Loss	165
On Farm Drying and Storage	166-169

## **Corn Tillage Studies:**

Corn Tillage	170-172
Strip-Till Freshener	173-174
Pre Plant Strip Freshener Nitrogen	175-177

## **Corn Intensive Management Studies:**

High Management NETAFIM® Irrigation	69
NETAFIM® Sub-Surface vs Surface	70-71
Tile Drainage & Sub-Irrigation	72-74
HyperSound Technology Irrigation	75
Strip Cropping/Livestock Sustainability	76-81
High Management AgroLiquid®	82-83
High Management Marco	84-85
High Management Corteva™	86-87
High Management QLF®	88-89
High Management Nachurs®	90-91
High Management NMS LLC	92-93
High Management New Fields Ag™	94-95
High Management Ag Xplore®	96-97
Golden Harvest® Genetics	98-99
GMO/Non GMO/Organic Corn	100-103

## **SOYBEAN**

### **Soybean Planting Principles:**

Planting Date	179
Multi-Year Early Plant Date	180
Soybean Early Plant Maturity	181
Starter Fertilizer Response by Date	182-183
SmartDepth® Planting Depth	184-186
Reveal® Residue Management	187-189
CleanSweep® Residue Management	190-191
Downforce Management	192-194
Keeton® Seed Firmer	195
Multi Genetic Planting	196-197
Singulation	198

SeedRight Bundle Drop Singulation	199
High Speed	200
Tillage/Closing Wheels	201-202
REVLIN® HOPPER THROTTLE™	203
Ridomil Gold® Granular Fungicide	204
HyperSound Technology Seed Treatment	205
Cover Crop Study	206-208
Summers® Rolling	254
Chopping Corn Head	270
Row Width and Seeding Rate	255-256

### **Soybean Dry Fertilizer Studies:**

Broadcast vs Banding	209
Broadcast vs Banding Rate Efficiency	210-212
Mosaic® Sulfur/Boron	213-214
Liquid vs Dry Fall Strip Till	215-217
Calcium Products SO4®	218

### **Soybean FurrowJet® Programs:**

Aqua Yield® NanoCS™	247-248
FurrowJet® Side-Wall	252

### **Soybean Foliar Programs:**

Revytek™ Foliar Fungicide	257
Fungicide/Insecticide	258-259
Miravis® Neo™ Foliar Fungicide	260-261
Aqua Yield® NanoPro®	262

### **Soybean Conceal® Programs:**

Marco Fertilizer Conceal® 14-12-4-6S	245
14-12-4-6S + NanoN+®	246
Phyco Terra®	250 - 251

### **Soybean Tillage Studies:**

Soybean Tillage	265-267
Pre-Strip Vertical Tillage	268
Spring Strip Till	269

### **Soybean Intensive Mgt. Studies:**

NETAFIM™ Irrigation Study	219
Soybean Seed Size	220
High Management Nachurs®	221-224
High Management AgroLiquid®	225-228
High Management Marco	229-232
High Management QLF®	233-236
High Management Corteva™	237-240
New Fields Ag™/NMS High Mgt	241-244
Dryland vs Irrigated ROI	249
Green Lightning PAW	263-264

## Introduction and Guide to Summary Report

Precision Planting is excited to share our 7<sup>th</sup> year of PTI research farm results and findings. We hope they provide useful insights that help drive thoughtful consideration around future crop management decisions. This publication is intended to summarize and explain the many agronomic trials that were implemented in 2024. This year we added new and interesting agronomy trials to our testing program, and we are excited to release our findings in this report.

During the summer of 2024, the PTI Farm hosted thousands of growers from throughout the United States as well as international countries including Australia, Germany, Canada, Argentina, Brazil, South Africa and the Ukraine. Farmers visited the PTI research farm to dive into agronomy field trials, see and understand real world agronomic problems, and were even able to experience some of the latest and greatest state-of-the-art technology in our ride and drive “Sandbox” area. Field days started in June and lasted until the 3<sup>rd</sup> week of September.

For the 2024 PTI Yield Summary Data, net returns are calculated with corn prices of \$4.08/Bu. and soybeans at \$11.46/Bu. These prices represent average **cash** prices for new crop 2024 corn and soybeans from October 1st, 2023, through October 1st, 2024. This simulates how growers could sell new crops throughout the year.

At the bottom of each trial summary page, a brief explanation is listed to show the planting date, hybrid or variety, population, row width, crop rotation, commodity price/bu. and cost information that pertains to the products being evaluated. Most starter fertilizer trials at the PTI Farm have a \$30 to \$40 re-allocation credit applied to each product in testing. This approach allows us to use the total intended fertility needed for soil test build-up and yield maintenance but allows the planned use of both dry fertilizer in the fall and liquid product on the planter without over-spending or over-applying more nutrients than needed. To accomplish this, we reduce our dry fertilizer rates by \$30 to \$40/A. to account for the reallocation. All control tests in each study get additional fertilizer to achieve a typical 100% program without starter fertilizer on the planter.

### Fall Dry Fertilizer: \$40 Reduction + At-Plant Liquid Starter



# MORE WAYS TO GET DATA

**PTI** PRECISION  
TECHNOLOGY  
INSTITUTE

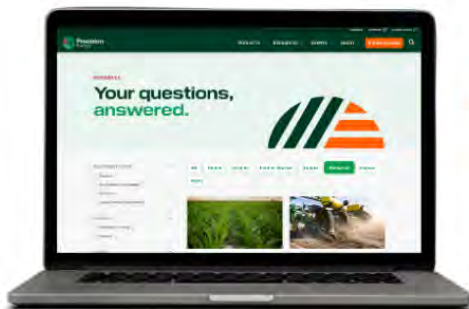

## RESEARCH ARTICLES

Where we go deeper into the studies while sharing our insights via video and more data.

[precisionplanting.com/resources](https://precisionplanting.com/resources)



## BECOME AN INSIDER

Join InsidePTI for research content delivered straight to your inbox.

[insidepti.com](https://insidepti.com)



**INSIDEPTI**



## VISIT THE FARM

Field days take place each summer giving you an in-person PTI experience.

[precisionplanting.com/pti](https://precisionplanting.com/pti)



## [NEW] PTI | NORTH DAKOTA

We've completed the first year of trials at PTI | ND and have results to share.

[precisionplanting.com/pti](https://precisionplanting.com/pti)

**PTI** NORTH  
DAKOTA

## Top and Bottom 10 Return on Investment Performance

Top 10	ROI \$/A.
1. NETAFIM™ Drip Irrigation	\$317.46/A.
2. Corn High Management	\$91.11/A.
3. Corn/Soybean Band vs. Broadcast Fertilizer Rate	\$89.16/A.
4. High Management Soybeans	\$73.38/A.
5. Phantom Yield Loss	\$72.85/A.
6. Soybean Fungicide/Insecticide	\$68.15/A.
7. FurrowForce® Closing System Pressure	\$66.91/A.
8. Corn Multi-Genetic Planting	\$61.61/A.
9. FurrowJet® Xyway® LFR® In-Furrow Fungicide	\$60.30/A.
10. Corn Smart Hydrogel Soil Moisture Retainer	\$59.09/A.
Bottom 10	
1. Too Early Planted Corn	-\$260.38/A.
2. Liquid vs. Dry Strip till Fertilizer	-\$225.80/A.
3. Corn Solar Corridor	-\$210.14/A.
4. In-Furrow Applied Nitrogen	-\$176.26/A.
5. Late Soybean Planting	-\$161.02/A.
6. Soybean Row Width	-\$136.45/A.
7. Non GMO/Organic Corn	-\$87.68/A.
8. Incorrect Weight Management & Tire Inflation	-\$71.02/A.
9. Wide Row Short Corn High Seeding Rate	-\$60.29/A.
10. Wide Row Corn	-\$59.52/A.

## Corn Planting Date Study

**Objective:** To evaluate various corn planting dates throughout the spring to determine the optimum planting date. Once the optimum planting date is discovered, economics can then be analyzed to determine yield loss and cost per acre when planting dates were not implemented within the optimum planting window.

**Results:** May 11<sup>th</sup> achieved this year’s optimum plant date at 279 Bu/A. (Table 1). Early planting dates of March 13<sup>th</sup> and April 16<sup>th</sup> suffered yield losses of **-63.8** to **-23.3 Bu/A.** Pushing planting date later to May 20<sup>th</sup> offered losses of **-10.3 Bu/A.**, May 26<sup>th</sup> losses of **-16.5 Bu/A.** while the latest plant date of June 3<sup>rd</sup> was **-44.4 Bu/A.** off the pace from optimum plant date.

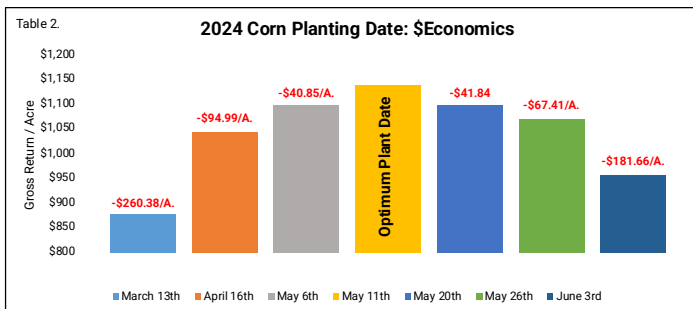
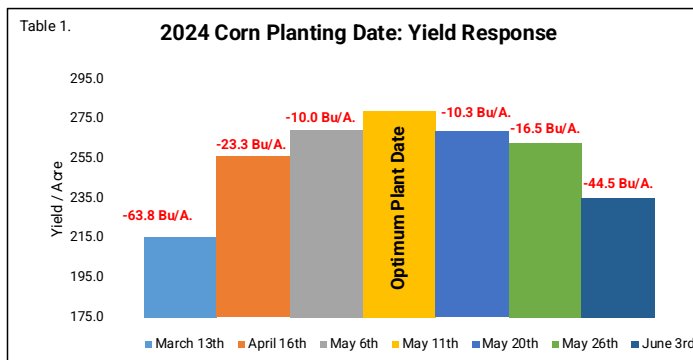

Table 2. illustrates losses of **-\$94.99** to **-\$260.38/A.** when pushing planting dates too early, with March offering the largest losses of the study. May 6<sup>th</sup> and May 20<sup>th</sup> proved the smallest losses of **-\$40.85** to **-\$41.84/A.** Later planting dates of May 26<sup>th</sup> proved losses of **-\$67.41/A.**, while June 3<sup>rd</sup> at **-\$181.66/A.**

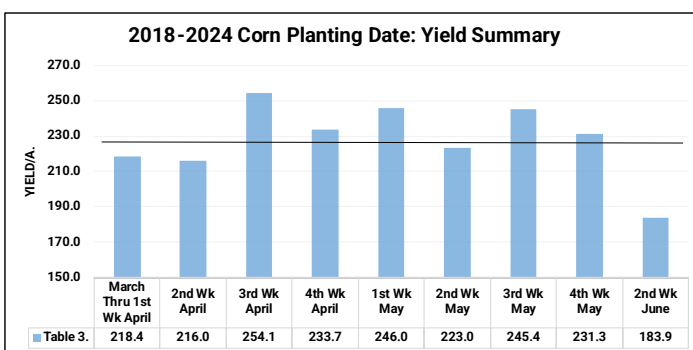

Table 3. summarizes the average yield from week-to-week plantings over a seven-year time-period from 2018-2024. Over this timeframe, the ideal planting date for corn has been the 3<sup>rd</sup> week of April. Highest yield losses have been ultra-early planting dates (March 1<sup>st</sup> to 2nd week of April) with losses of -36 Bu/A. to -38 Bu/A., as well as June plantings with losses of near 70 Bu/A. In general, 3<sup>rd</sup> week April through 1<sup>st</sup> week of May plantings have all proven optimum window. It is interesting to note that 2<sup>nd</sup> week of May plantings have fallen short of average yield, due to the commonality of “Mother’s Day Massacre” storm events.

## Corn Starter Fertilizer Response by Planting Date Study

**Objective:** To monitor the performance of starter fertilizer at various planting dates. When does starter fertilizer give the highest returns? Does starter fertilizer respond differently at earlier planted dates versus later? In this study we evaluate five planting dates consisting of April 16<sup>th</sup>, May 6<sup>th</sup>, May 11<sup>th</sup>, May 20<sup>th</sup>, and May 26<sup>th</sup> with and without a starter fertilizer, monitoring its performance throughout the planting season.

The starter fertilizer program used for this study consists of the following:



<u>Product</u>	<u>Fertilizer Analysis</u>	<u>Placement of Fertilizer</u>
6 Gal/A. Nachurs® Triple Option®	4-13-17-1S	FurrowJet® Wings
1Qt/A. Nachurs® Face Off®	1-0-1-.3Cu-.6Mn-.005Mo-3Zn	FurrowJet® Center
2 Qt/A. Nachurs® K-fuel®	0-0-24	FurrowJet® Center
2 Gal/A. Nachurs® Throwback®	8-27-4-2S	Conceal® Single Band
20 Gal/A.UAN	32-0-0	Conceal® Single Band
2 Gal/A. Nachurs® K-Fuse®	6-0-12-12S	Conceal® Single Band

Figure 1. FurrowJet® Placement

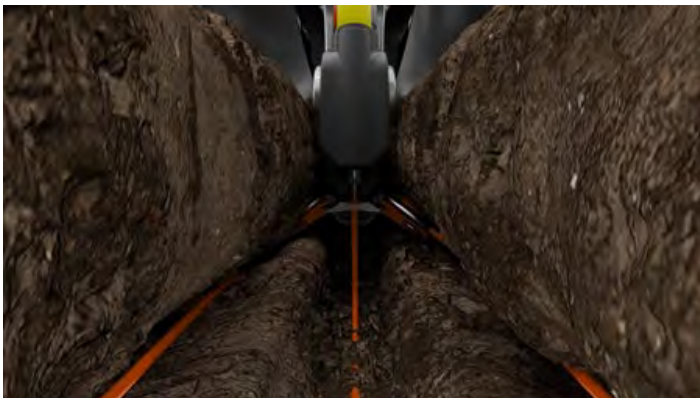

Figure 2. Conceal® Placement





## Corn Starter Fertilizer Response by Planting Date Study Continued

**Results:** Table 1. illustrates that early planting dates up through May 11<sup>th</sup>, achieved yield gains from starter fertilizer. All other later planting dates resulted in gains of +1.2 Bu/A. to +2.5 Bu/A.

Weather data (listed below) proved cold soil temperatures during the last half of April, that provided a perfect environment (cold/wet) for excellent starter fertilizer response.

Table 2. illustrates positive economic net return of +\$13.76 to +\$15.39/A. from starter fertilizer applications on April 16<sup>th</sup> and May 6<sup>th</sup>. However, all later plantings resulted in losses ranging from **-\$0.52** to **-\$32.76/A.**

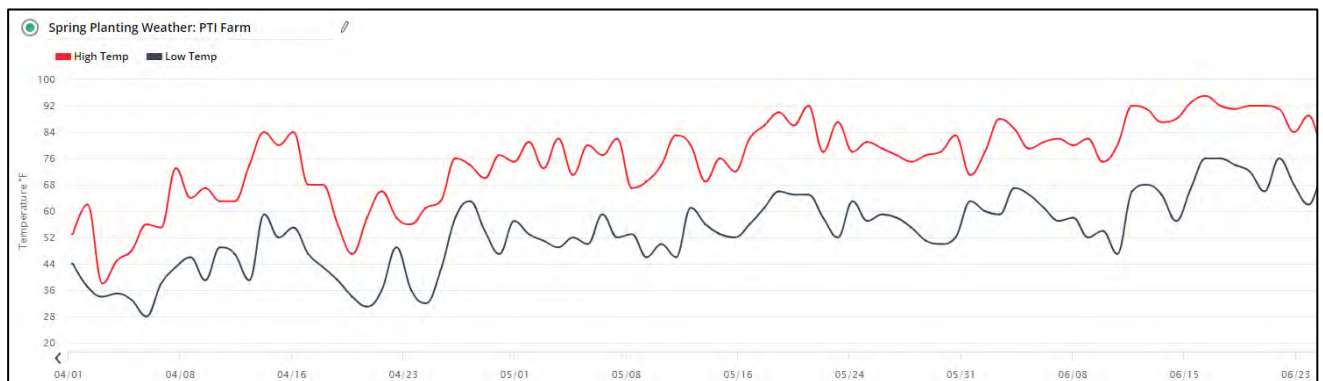
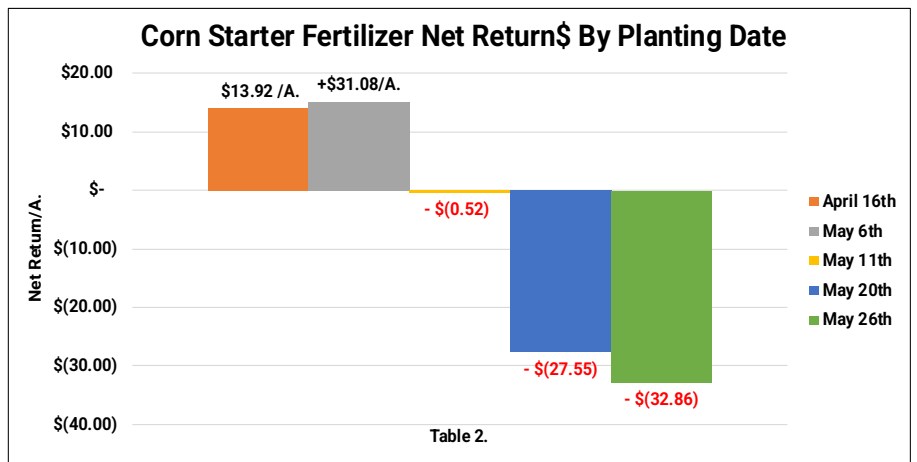
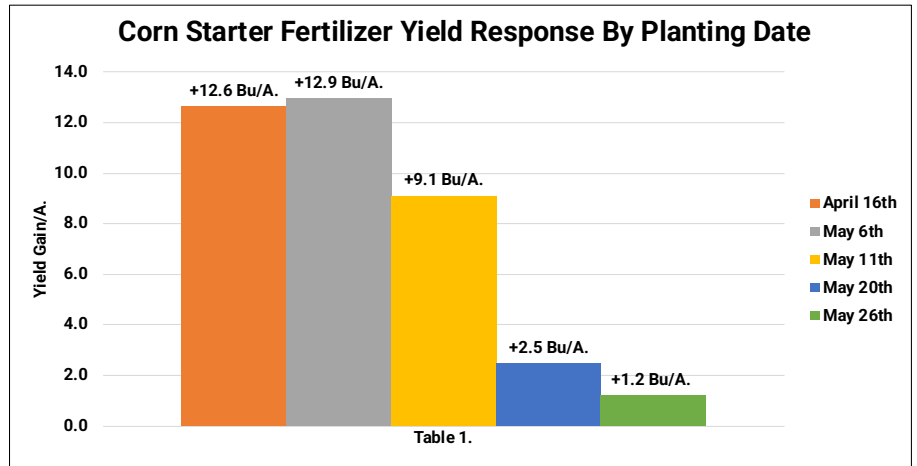

Planting Date: Varied    Hybrid: GH 15J91    Population: 36K    Row Width: 30"    Rotation: CAB    Corn Price: \$4.08  
 Starter Program Cost: \$77.65    \$40 Fertilizer Reallocation

## vSet® Planter Singulation Study

**Objective:** To evaluate how improper seed singulation affects corn yield. Modified vSet® seed plates with plugged and extra holes were used to create skips and doubles. These “goof” plates created an average of 95% spacing accuracy vs. the control at 99.5%.

Extra Holes = Doubles

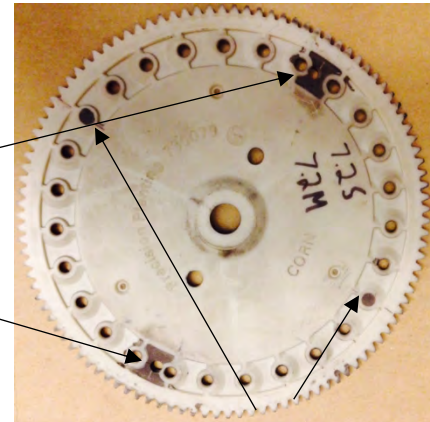

Plugged Holes = Skips

**Results:** The table below illustrates 95% seed singulation resulted in an average economic loss of **-\$38.21/A.** over a 7-yr period of 2018-2024.

Over this same time period, for each percentage of singulation lost, yield was decreased by an average of **-1.94 Bu/A.**

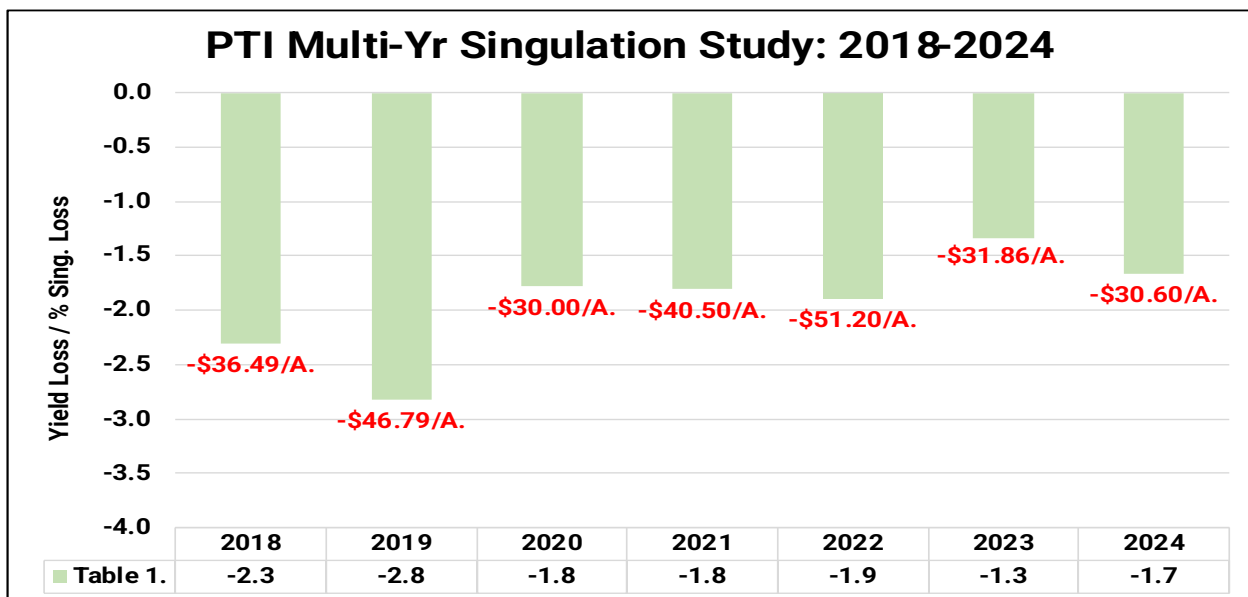

Planting Date: May 24<sup>th</sup>    Hybrid: GH 12U11    Tillage: Strip-Till    Population: 36K    Row Width: 30"    Rotation: CAB    Corn Price: \$4.08

## SmartDepth® Corn Planting Depth Study

**Objective:** To evaluate yield and economic performance of various manual corn planting depths consisting of 1" to 3" in ¼" increments, compared to automated variable depth planting using SmartDepth® control.

Digging seeds is a time consuming yet important task at planting time (Figure 1). Getting your eyes on the furrow where the seeds are placed will allow you to understand if those seeds are in an environment to thrive. Is the seed being planted into adequate moisture? Until now, we did not know this for every seed, and we were unfortunately simply guessing.

With a SmartFirmer® sensor (Figure 2.) you can now have virtual eyes in the furrow. Soil moisture is a critical component for seed germination, uniform plant emergence, and ultimately crop yield. SmartFirmer® sensors gives row-by-row visibility to soil moisture in the seed furrow, allowing farmers to choose the right planting depth as soil conditions change. Currently, the recommendation for ideal furrow moisture levels to achieve adequate corn emergence, is near 32%. Using the 20|20® monitor (Figure 3.) in tandem with SmartFirmer® sensors, we now have the ability to evaluate furrow moisture in real-time. Based on this real-time information, growers can make decisions based on live sensing data.

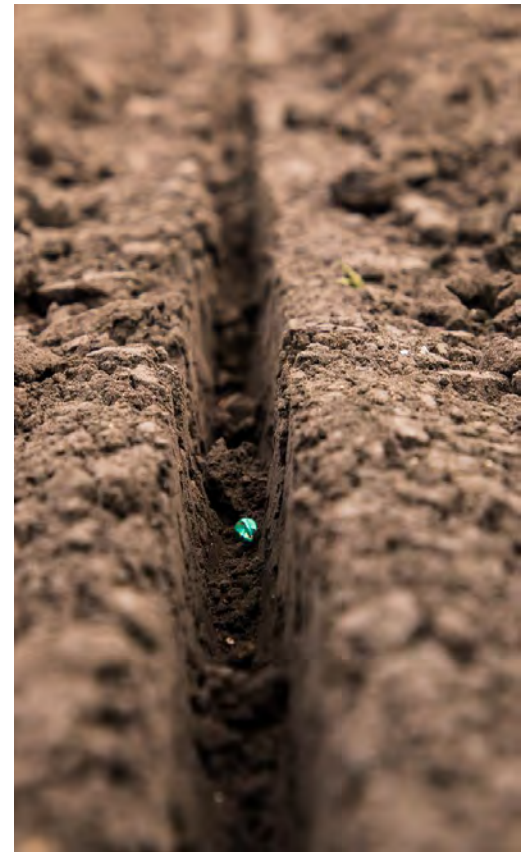

Figure 1. Seed Furrow



Figure 3. 20|20® Monitor System



Figure 2. SmartFirmer® Sensor

## SmartDepth® Corn Planting Depth Study Continued

Figure 4. illustrates SmartDepth®, a unique product that takes the technology one additional step further, allowing planting depth to be changed on a planter, by section or individual row basis. This can be done manually from the tractor cab and 20|20® console or automatically using furrow moisture values from SmartFirmer® sensors. Growers can customize their own settings to optimize both furrow moisture and planting depth values (Figure 5). This control allows growers to measure, react, and take control of planting depth to optimize emergence timing.



Figure 5. SmartDepth® Customization Screen

Figure 4. SmartDepth® Control System

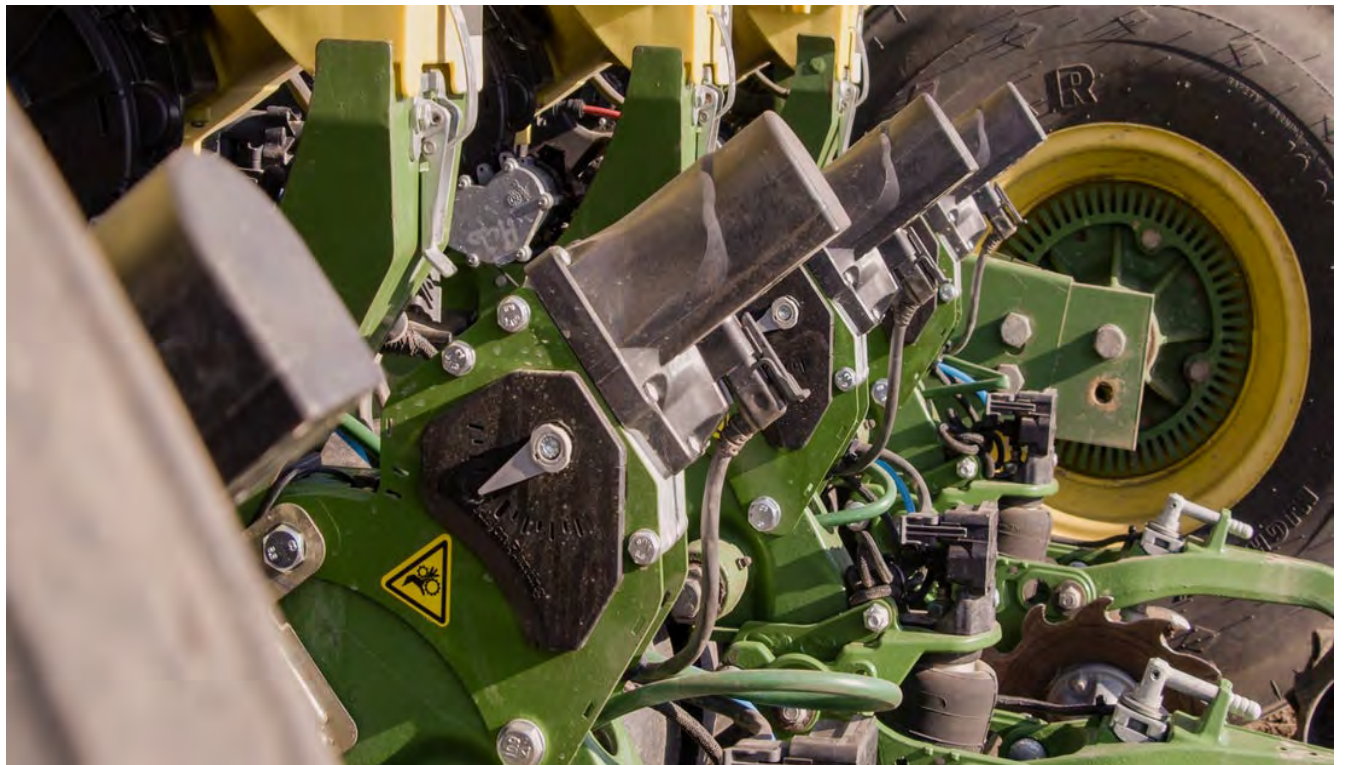

## SmartDepth® Corn Planting Depth Study Continued

**Results:** Tables 1-2. reveal that SmartDepth® achieved corn yield within 1.8 Bu/A. of the optimum planting depth of 1.25" and economic variance of only \$7.34/A.

The telling story in this study is furrow moisture levels. Table 3. illustrates average furrow moisture of 39.2%. Currently, the recommendation for ideal furrow moisture levels to achieve adequate corn emergence is near 32%. Table 3. indicates all planting depths had furrow moisture over 32%. This indicated good field moisture and deeper planting depths were not needed.

By using SmartDepth®, SmartFirmer® and a 20|20® monitor system, growers can obtain perfect planting depths just below the furrow moisture line.

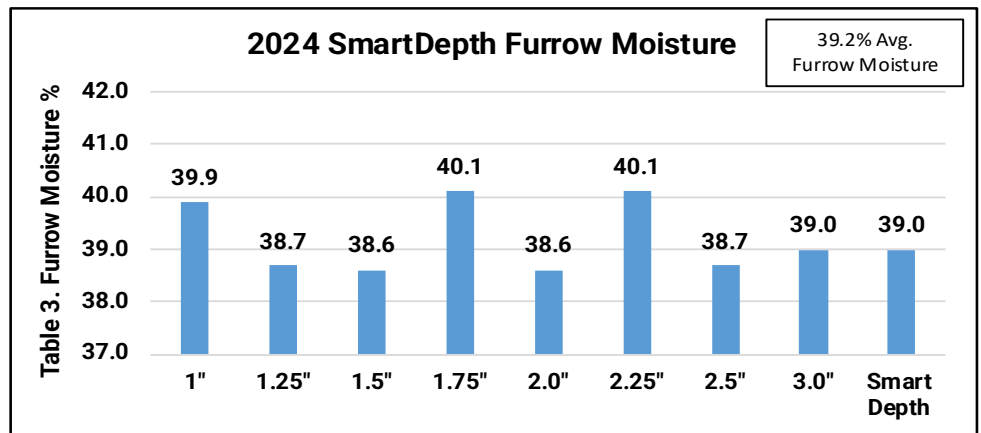
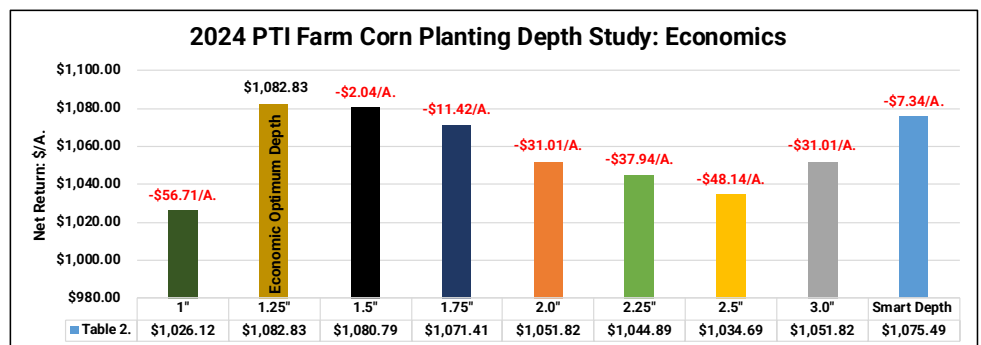
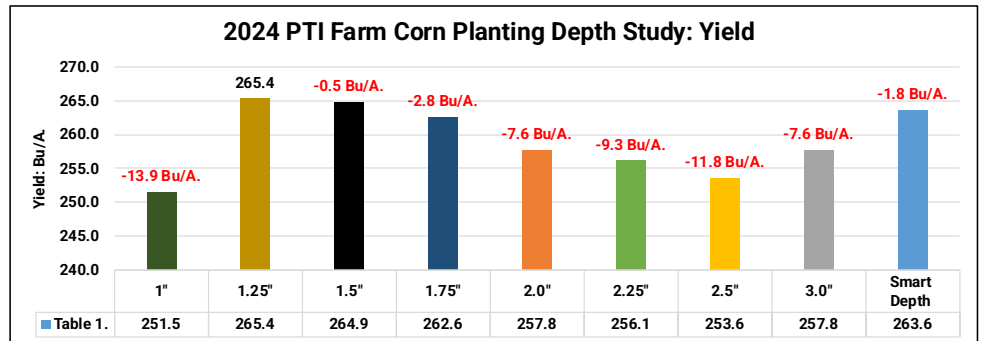

Planting Date: May 25<sup>th</sup>    Hybrid: Golden Harvest 12U11    Population: 36K    Row Width: 30"    Rotation: CAB    Corn Price: \$4.08

## Reveal® Residue Management Study

**Objective:** This study evaluates the yield and economic benefit of Reveal®, a frame mounted row cleaner system in a corn after corn strip-till environment.

Residue management is a necessary part of today's operation to maximize profitability. Tougher stalks and more corn-on-corn acres mean a heavier load of residue that needs to be controlled. Residue in the seed trench competes with seedlings for moisture and can harbor diseases.

Reveal® (Figure 1-2.) is frame mounted, so unlike other row cleaners, it gets rid of that row unit chatter. It has an internal gauge wheel that precisely controls the depth of the cleaning tines. It also has an airbag that makes sure the depth that it's set at, stays consistent. The pressure of the airbag can be controlled on the 20|20® monitor or utilizing a manual controller in the cab.

In this agronomic study, we compared the absence of row cleaners, and floating row cleaners to that of Reveal® at notch 1 and 20 PSI setting.

Figure 1. Reveal® System



Figure 2. 20|20® System

## Reveal® Residue Management Study Continued

**Results:** Table 1. illustrates the summary of all residue manager systems. Compared to the control of 100% lift, the Reveal® residue management system at 20# PSI down in notch 1, wheel settings, provided the highest yield gains in the study, with gains of +2.9 Bu/A, and corresponding return on investment of +\$11.83/A. Floating row cleaners realized +1.2 Bu/A. gain to that of the control.

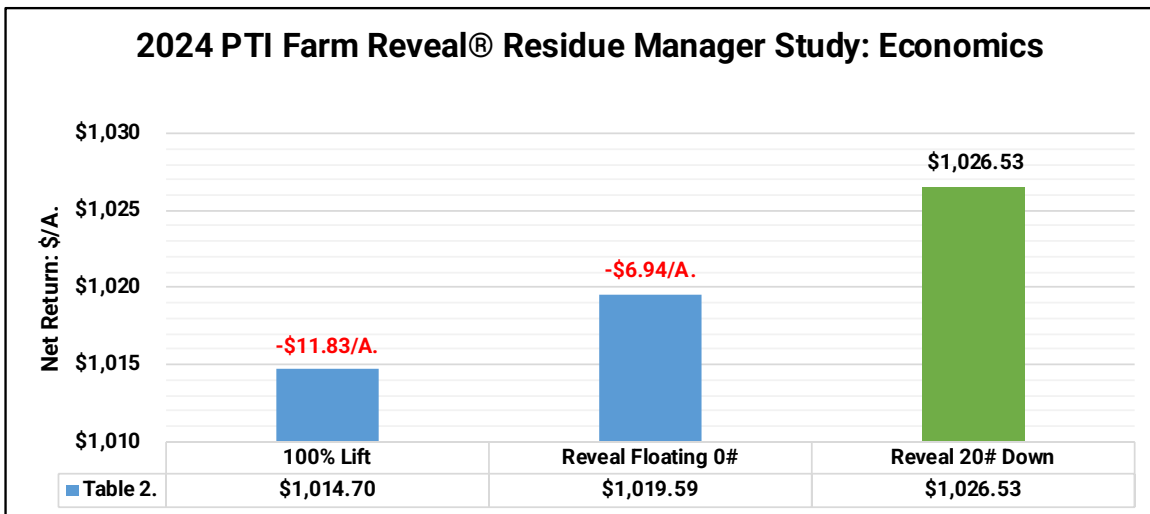
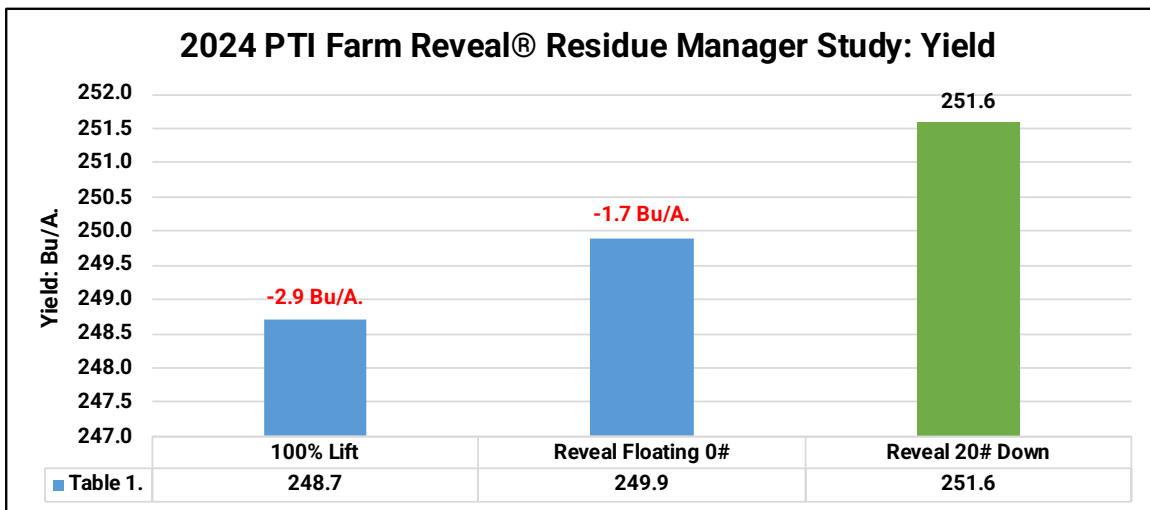

Planting Date: May 15<sup>th</sup> Hybrid: Golden Harvest 12U11 Tillage: Strip-Till Population: 36K Row Width: 30" Rotation: CAB Corn Price: \$4.08

## CleanSweep® Residue Management Study

**Objective:** This study evaluates the benefits of planter row cleaners equipped with CleanSweep® cylinders. Residue management has become a necessary part of today's operation to maximize profitability. Tougher stalks and more corn-on-corn acres mean a heavier load of residue that needs to be controlled. Residue in the seed trench competes with seedlings for moisture and harbors disease. CleanSweep® cylinders put row cleaners right where they need to be, moving residue but not the soil. Continuous adjustments can be made as field conditions change with the cab-mounted controller to easily lift or make more aggressive adjustments.

In this study, we use air pressure to adjust CleanSweep® cylinder settings on Yetter 2967 spike row cleaners to allow the ability to change and evaluate the aggressiveness of row cleaners. These settings were then evaluated to study yield and economic advantages.

These agronomic settings consisted of:

1. Lifting the row cleaners 100% to simulate the lack of row cleaners.
2. A "floating" (0# psi) position that allows the row cleaner to ride along top of the soil surface with no air control, lift, or down-pressure.
3. 20# of air down-pressure, just aggressive enough to wipe crop residue and clods out of the way to lead a clean path ahead of the planter gauge wheels and seed disc openers.

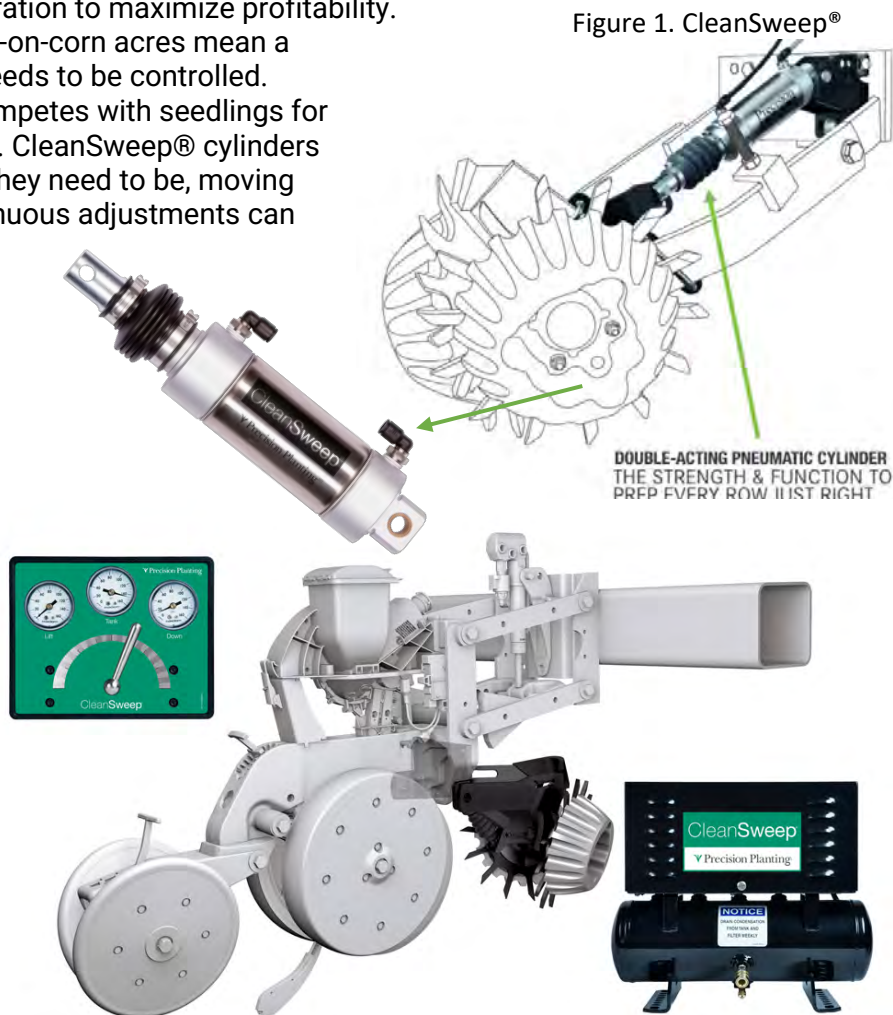



## CleanSweep® Residue Management Study Continued

**Results:** Table 1. illustrates CleanSweep® cylinder yield results from the PTI Farm in 2024. Row cleaners provided a yield benefit of +8.4 Bu/A, compared to the 100% lift setting of no row cleaners. Floating row cleaners proved losses of **-1.7 Bu/A.** compared to the more aggressive grower setting of 20#psi down.

Tables 2-3 summarize multi-year average yield and economic gains from CleanSweep® cylinders during the growing seasons of 2018-2024. During this time-period, row cleaners equipped with CleanSweep® cylinders at 20#psi down realized +8.3 Bu/A. yield gains compared to using no row cleaners. These gains resulted in gross revenue increases of +\$33.61/A.

This same 20#psi down setting also improved yields over the 0# float position by +2.4 Bu/A. and consequently improved revenue by +\$9.30/A.

Figure 2. Yetter Row Cleaners with CleanSweep®

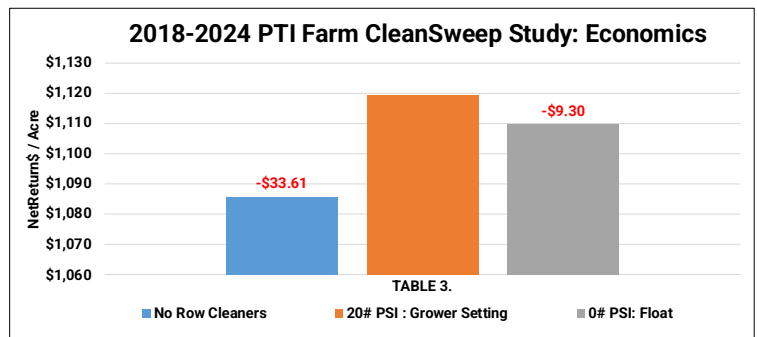
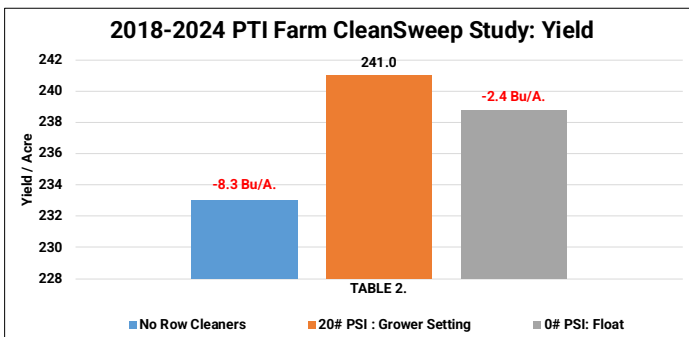
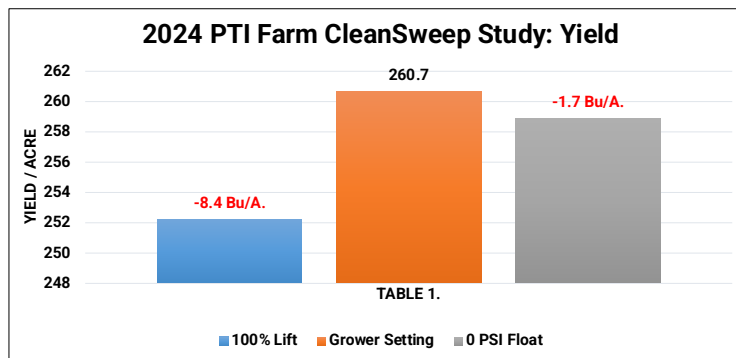

Planting Date: May 15<sup>th</sup> Hybrid: Golden Harvest 12U11 Tillage: Strip-Till Population: 36K Row Width: 30" Rotation: CAB Corn Price: \$4.08

## Multi-Year Day of Emergence Study

**Objective:** This multi-year study illustrates the impact of yield loss when corn plants emerge from the soil surface on an inconsistent basis. Flag testing implementation (Figure 1.) was used to monitor the emergence timing of young plants each year. As corn first started to emerge from the soil surface, flags were placed at five different timings to identify the emergence of all plants within the study.

Figure 1.



**Protocol:**

- 12 hours** = 1<sup>st</sup> initial plants to emerge
- 24 hours** = Plants that emerged 24 hours later
- 36 hours** = Plants that emerged 36 hours later
- 48 hours** = Plants that emerged 48 hours later
- 48+hours**= Plants that emerged >48 hours later

**Results:** Manual ear checks were completed to calculate potential yield loss from late emerging plants. Table 1. below summarizes yield loss as emergence varied over the 7-year study. Plants that emerge in the first 12 hours are considered the best achievable performance and therefore used as the baseline control with 100% yield potential. As plants emerged 24 hours later, **-13.5%** yield losses were realized compared to the first emergers. As emergence continued to 36-hour delay, yield fell to **-29.2%** losses. 48-hour delay in emergence resulted in yield deficits of **-65.5%** and finally, the latest emergers that came up >48-hours proved devastating losses of **-71.7%**.

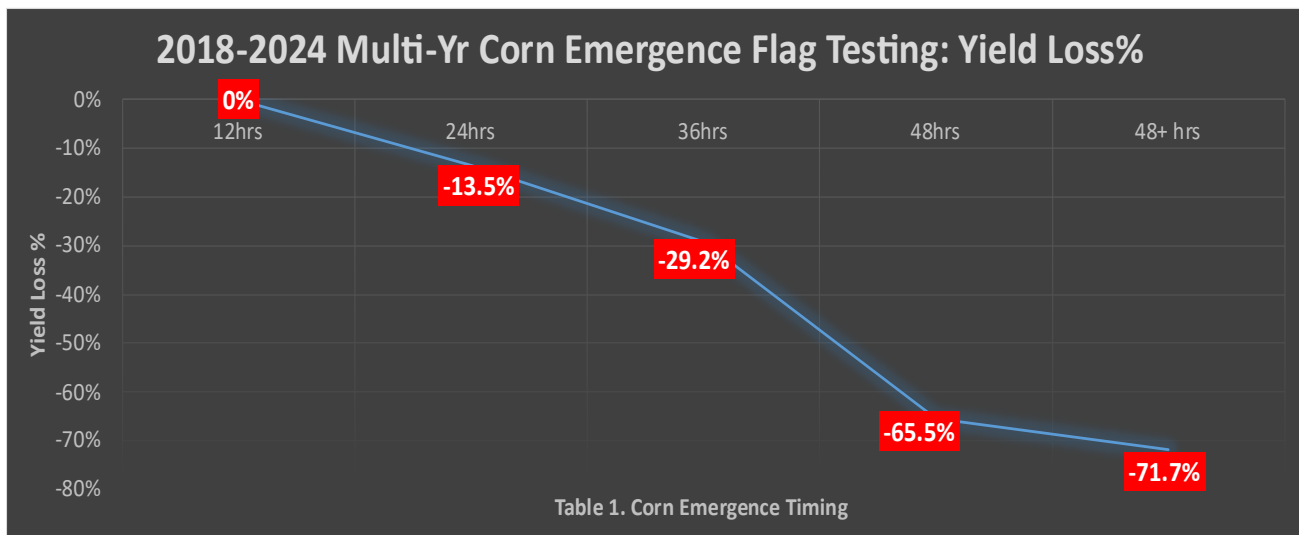

## SpeedTube® Corn High Speed Planting Study

**Objective:** To evaluate yield response of planting speeds at 4, 6, 8, and 10 MPH with a SpeedTube® system. This high-speed planting technology takes the place of conventional seed tubes and consists of a flighted belt. By transporting each seed to the furrow, there is no opportunity for seeds to ricochet into the trench. Even at twice normal planting speeds, seed arrives safely at the bottom of the trench, spaced evenly, every time.



**Results:** Table 1. summarizes multi-year data from 2018-2024, with SpeedTube® planting at speeds of 4, 6, 8, and 10 MPH only varying 2.1 Bu/A.

With traditional planting speeds typically near 5 mph, this data would suggest that growers could plant twice as fast without sacrificing planter performance. With being able to plant almost twice as fast this would allow farmers to wait until planting conditions are perfect to plant, resulting in the best yields.

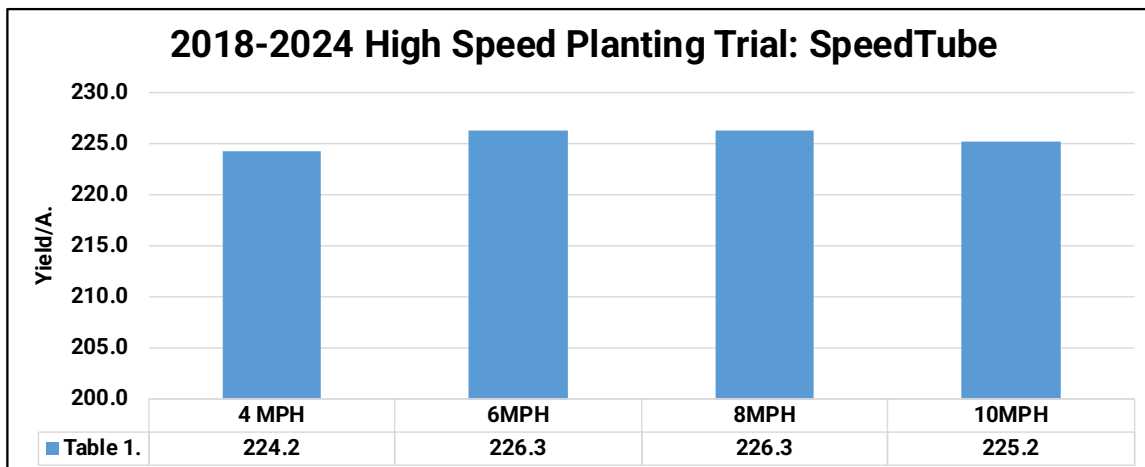

Planting Date: May 15<sup>th</sup>

Hybrid: DKC 65-95RIB

Population: 36K

Row Width: 30"

Rotation: CAB

Corn Price: \$4.08

## High Speed Planting Without High Speed Technology Study

**Objective:** To evaluate yield response of planting speeds of 5 and 10 MPH with a WaveVision® Seed tube system and a SpeedTube® system.

Figure 1. WaveVision® SeedTube

Seed tubes are designed for typical planting speeds of 4 to 6 MPH and is not high speed technology.

WaveVision® is a seed sensor within the seed tube that counts only seeds and not dust, giving you confidence that the population you see on your monitor is the population that you're planting. WaveVision® does not incorporate an optical sensor in the housing, meaning there is no opportunity for seeds to ricochet into the trench. Instead, high-frequency radio waves measure mass instead of shape.

SpeedTube® is high-speed planting technology that takes the place of conventional seed tubes and consists of a flighted belt. By transporting each seed to the furrow, there is no opportunity for seeds to ricochet into the trench. Even at twice normal planting speeds, seed arrives safely at the bottom of the trench, spaced evenly, every time.

**Results:** The table below illustrates how seed tube performance fell by **-11.41 Bu/A.** when increasing planting speed from 5MPH to 10MPH, resulting in economic losses of **-\$46.55/A.** Where when increasing planting speed from 5MPH to 10MPH there was a +0.78 Bu/A. resulting in gains of

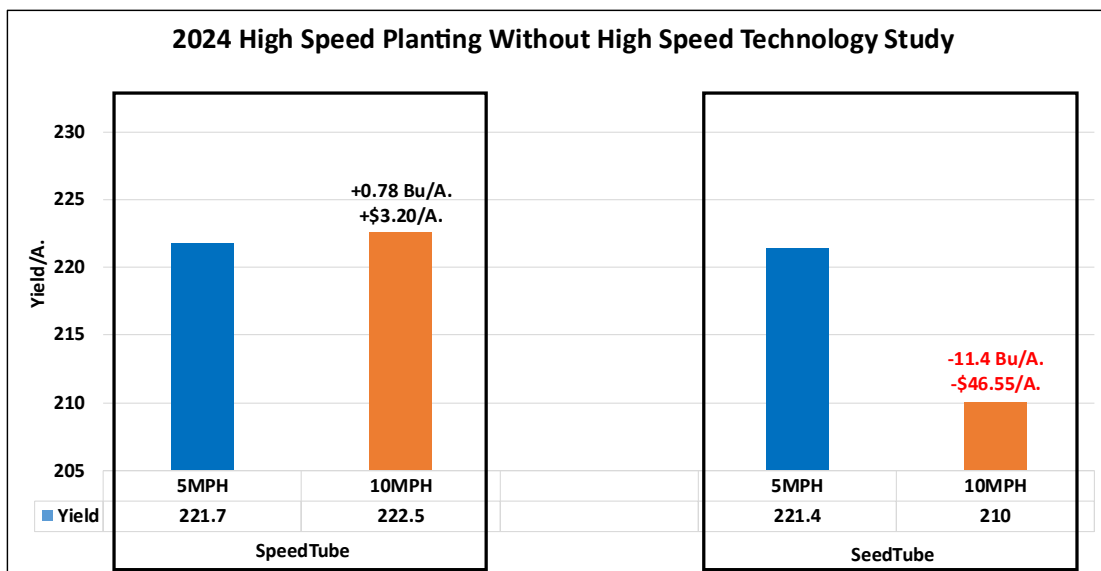

Planting Date: May 15<sup>th</sup>    Hybrid: GH 12U11    Tillage: Strip-till    Population: 36K    Row Width: 30"    Rotation: CAB    Corn Price: \$4.08

+\$3.20/A.

## FurrowForce® Closing System Study

**Objective:** To evaluate the yield response of FurrowForce® closing system at 3 different system pressures, in 4 different types of tillage practices. This study evaluates the benefits of planter retrofitted with a FurrowForce system. Setting your closing system correctly is tough. FurrowForce is a two-stage closing system that adapts to your planting conditions to remove air pockets and firm soil to keep moisture, giving you confidence that your crops will germinate the best that they can.

Figure 1. FurrowForce®



In the first stage, notched wheels work to close the seed furrow from the bottom up, fracturing to eliminate air pockets, even in extreme no-till conditions where traditional closing systems struggle. In the second stage, stitch wheels carry weight on them to firm the soil. This consistent firming is especially beneficial behind spring tillage where the seed environment is at risk of drying out.

In this study, we use air pressure to adjust pressure pushing down on our closing system to change and evaluate the aggressiveness of closing the furrow. These settings were then evaluated in no-till, vertical till, strip-till, and conventional tillage to study yield and economic advantages.

These agronomic settings consisted of:

- Light – 15 PSI down
- Standard – 35 PSI down
- Heavy – 55 PSI down



## FurrowForce® Closing System Study

**Results:** Tables 1-4. illustrates FurrowForce yield results from the PTI Farm in 2024. Light FurrowForce proved a yield loss in all 4 tillage practices at an average of **-6.1 Bu/A**, compared to the standard setting. However, the heavy setting proved average gains across the four tillage practices of **+6.4 Bu/A**. compared to the standard setting. In a tougher to close, no-till environment heavy FurrowForce proved the largest yield increase of **+16.4 Bu/A**.

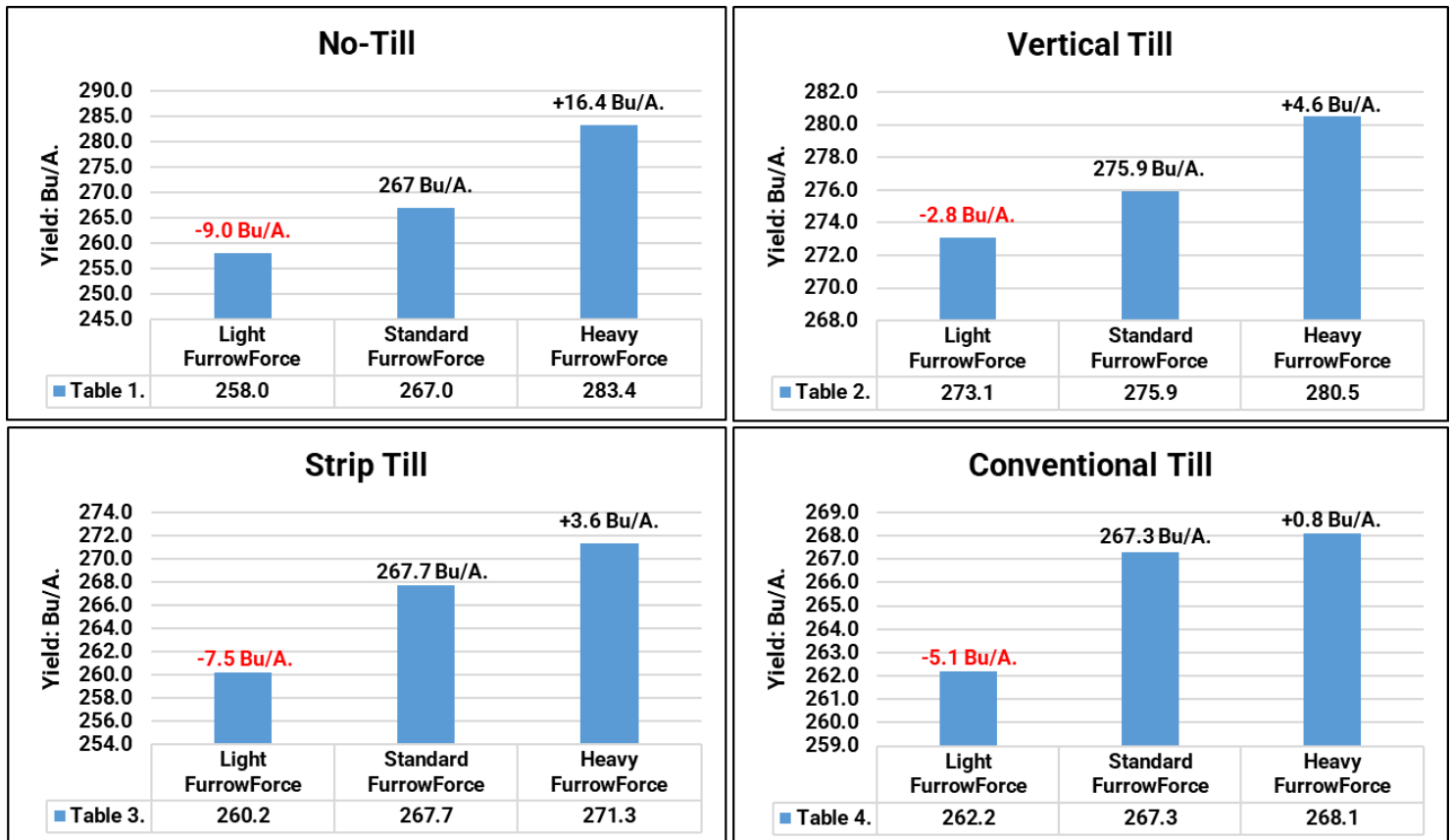

Planting Date: May 24<sup>th</sup> Hybrid: Golden Harvest 12U11 Tillage: Strip-Till Population: 36K Row Width: 30" Rotation: CAB Corn Price: \$4.08

## Corn Tillage/Closing Wheel Study

**Objective:** To evaluate the performance of non-sensing single-stage and two-stage automatic sensing closing systems in four different tillage practices including conventional, strip, vertical, and no-till.

Closing systems are designed to close the seed trench, eliminate sidewall smear, compaction and to remove air pockets, all while achieving good seed-to-soil contact.

### Two Goals of Proper Closing

#### 1. Remove Air Pockets

#### 2. Lift and Fracture Side-Walls

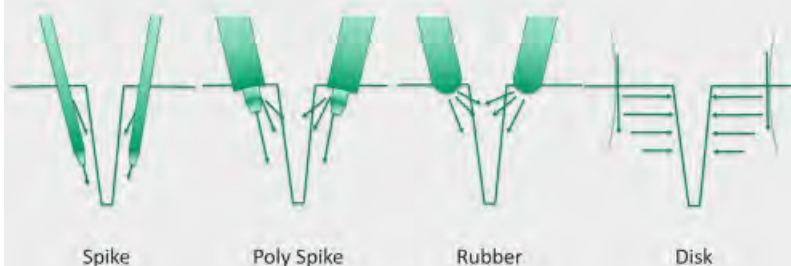

Spike

Poly Spike

Rubber

Disk



Figure 1. Air Pocket Causing Poor Seed to Soil Contact



Figure 2. Good Seed to Soil Contact

## Corn Tillage/Closing Wheel Study Continued

This tillage/closing study evaluates yield and economics of six distinctly different types of closing wheel systems, in four different tillage systems including the following:



### **FurrowForce® Automated Control Closing System:**

- Advantages:           Lifts and fractures sidewall compaction/smear  
                              2nd stage stitching and removal of air pocket  
                              Ability for automatic sensing/control of soil variability
- Disadvantages:       Rocks can be problematic, increased cost



### **Non-Sensing Traditional Dual Rubber Closing System:**

- Advantages:           Sealing or “Pinching” in dry conditions
- Disadvantages:       Difficult to lift/fracture sidewalls, struggles to close furrow



### **Non-Sensing Dual Yetter Poly Twister® Closing System:**

- Advantages:           Lifts and fractures sidewall compaction/smear  
                              Center ring acts as depth maintainer
- Disadvantages:       Lightweight wheels require increased tension



### **Non-Sensing Martin-Till® fCrusher Closing System:**

- Advantages:           Tapered tooth design – Lightweight Cast  
                              Allows firming and crumbling.
- Disadvantages:       Single Stage, Potential to Overpack



### **Non-Sensing Dual Yetter Cast Twister® System:**

- Advantages:           Ring-only option for easy installation  
                              Allows firming and crumbling
- Disadvantages:       Single Stage, Potential to Overpack



## Corn Tillage/Closing Wheel Study Continued



### Non-Sensing Case Manual Two Stage System:

- |                |   |
|----------------|---|
| Advantages:    | Lifts and fractures sidewall compaction/smear |
|                | 2nd stage removal of air pocket               |
|                | Multiple Manual Settings for easy adjustment  |
| Disadvantages: | Manual control – no sensing                   |

Figure 1. Kuhn® EXCELERATOR® XT 8010 Vertical Tillage

Four tillage systems were evaluated in the study to evaluate the difference in closing performance.

**Vertical-Till (Figure 1.)** In the fall after harvest, vertical tillage was used to mix, cut, and level residue in a 3” depth tillage pass. Herbicide was used as a burndown to control early season weeds in the absence of spring tillage.

**No-Till: (Figure 2.)** Planting directly into last year’s soybean stubble with no tillage activity performed. Herbicide was used as a burndown to control early season weeds in the absence of tillage.

**Conventional-Till (Figure 3.)** In the fall after harvest, deep 13” ripping with aggressive cutting and mixing of residue. A spring soil finisher leveled before planting.

**Strip-Till (Figure 4.)** In the fall after harvest, 10” deep strips were created with a strip-till unit. Herbicide was used as a burndown to control early season weeds in the absence of spring tillage.



Figure 2. No-Till Planter



Figure 3. Sunflower® 4630 Disc-Ripper

Figure 4. Kuhn® Krause® 1200 Gladiator® w/ Montag® Fertilizer Cart



## Corn Tillage/Closing Wheel Study Continued

### Results:

**Conventional Till:** Minimal yield variance occurred within all closing systems with a spread of 6.6 Bu/A. Manual FurrowForce® outperformed all other closing systems in conventional tillage. The Case 2 stage system had the highest loss in this tillage losing **-6.6 Bu/A.** compared to automated FurrowForce®

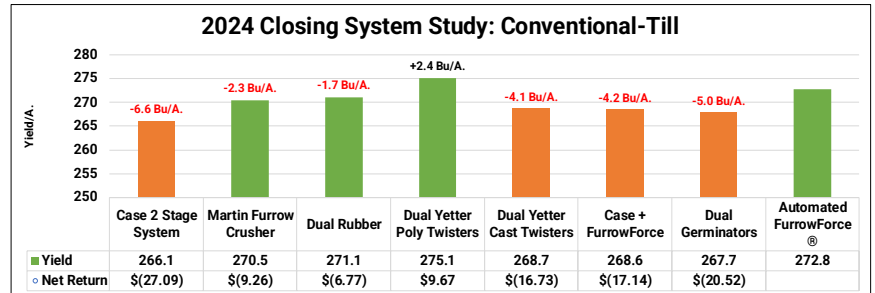

**Vertical-Till:** Manual FurrowForce® outperformed all other closing systems in vertical tillage. FurrowForce® proved positive yield gains compared to all other closing systems by +0.9 to +8.2 Bu/A. In this difficult to close planting environment, Dual Rubber proved the highest yield losses of **-11.3 Bu/A.** with revenue losses of **-\$45.94/A.** All other closing systems resulted in revenue losses of **-\$3.71 to -\$33.29/A.**

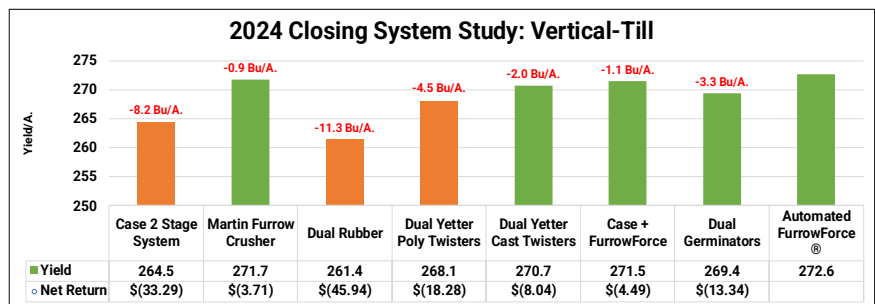

**Strip-Till:** FurrowForce® proved positive yield gains compared to all other closing systems by +0.3 to +5.6 Bu/A. All other closing systems performed similarly in this tillage system with revenue variance of **-\$1.35 to -\$22.85/A.**

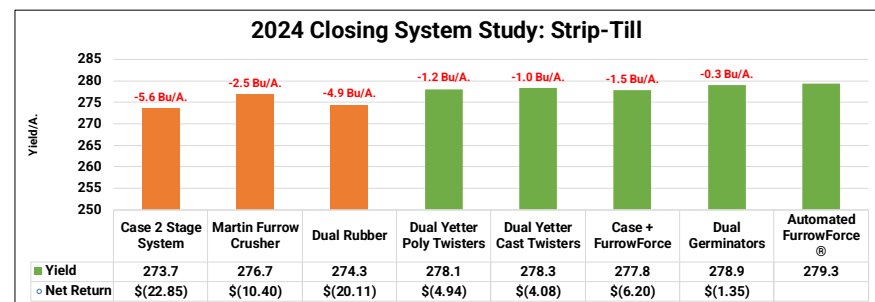

**No-Till:** FurrowForce® outperformed all closing systems with yield gains of +2.6 to +13.2 Bu/A. In this tougher to close type environment, all closing systems suffered, however dual traditional rubbers and Yetter Poly Twisters provided the largest discrepancy with yield losses of **-13.2** and **-6.4 Bu/A.** with economic losses of **-\$26.03 to -\$53.69/A.**

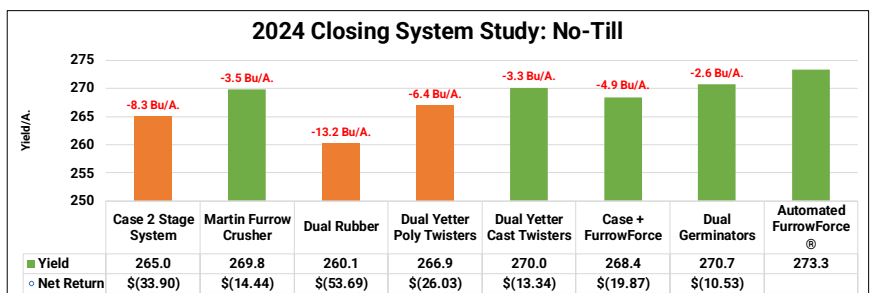

## Corn Tillage/Closing Wheel Study Continued

Overall, FurrowForce® two-stage manual closing system resulted in average yield gains of +3.9 Bu/A. and additional revenue of +\$16.31/A. across all tillage environments.

However, the clear advantage for FurrowForce® occurred in reduced tillage environments such as no-till and vertical tillage. In these programs, average yield gains of up to +4.5 to +6.0 Bu/A. with increased revenue of +\$18.16 to +\$24.54/A. clearly indicate that in tougher closing situations, a more robust system is needed to effectively close the furrow.

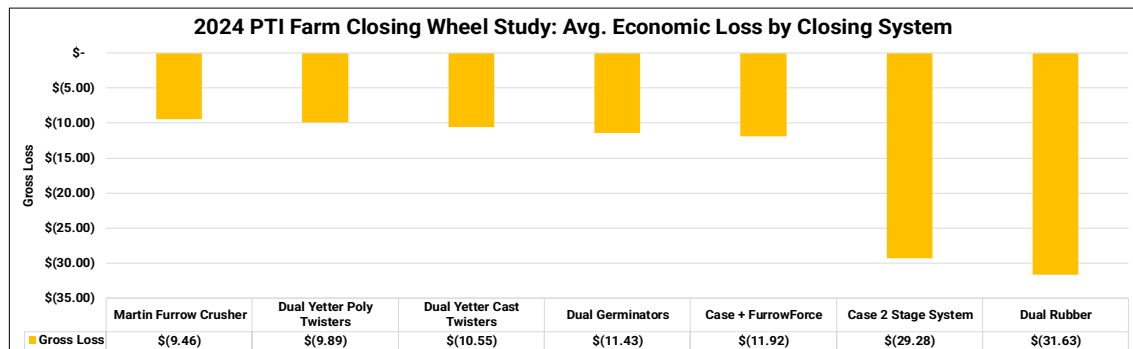
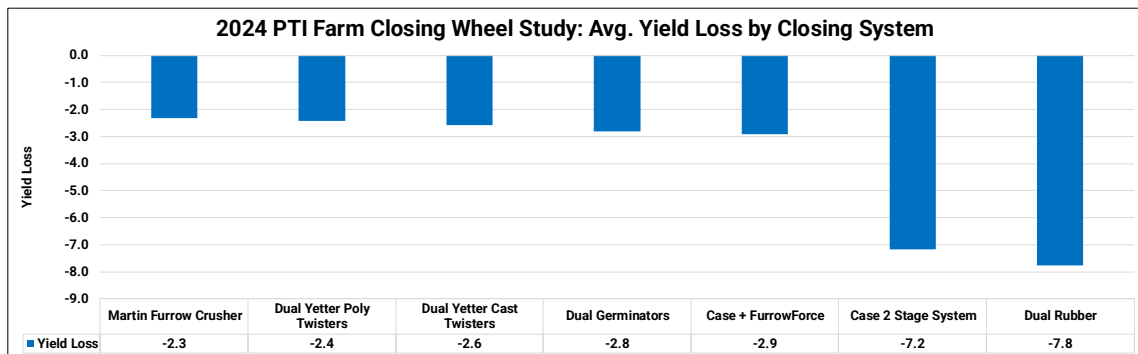

In summary, for years planters have struggled with closing systems with manual settings that offered the inability to account for and change for varying soil conditions. Today, we are excited that technology finally exists where farmers can use sensing technology on the planter row unit to determine how much force is needed on closing systems to address soil variability. By using a robust 2-stage closing system, load pin and sensing architecture, partnered with a 20|20® monitor, farmers can be confident of closing the seed trench, eliminating sidewall compaction/smearing, and removing air pockets all while planting through various seedbed conditions on a pass-pass basis.

Planting Date: May 11<sup>th</sup>    Hybrid: Wyffels 6886 VTDP    Population: 36K    Row Width: 30"    Rotation: CAB    Corn Price: \$4.08

## DownForce Management Study

**Objective:** Planter row unit downforce is a common agronomic issue that often goes unaddressed. This study evaluates yield impact of implementing proper downforce, compared to too light or too heavy row unit settings. When downforce matches field conditions, the depth of planting is consistent and correct. Too light of row unit downforce causes planting depth to shallow up, potentially placing seed in dry soil, thus creating poorly rooted plants that struggle for water and nutrients. Conversely, too much downforce can lead to furrow side-wall compaction, also creating an environment that can cause limited plant access to water and nutrients.

DeltaForce® system replaces the springs or air bags on your planter with hydraulic cylinders (Figure 1.) It automatically increases or decreases weight with military precision, on each row individually. When one row encounters conditions different than another (wheel tracks, old roadbeds, clay knobs, headlands, etc.), each will adjust independently (Figure 2). Row by row, foot by foot, and seed by seed, you produce an environment that fosters uniform germination, optimum growth, and maximum yield.

Figure 1. DeltaForce® Cylinder



Figure 2.

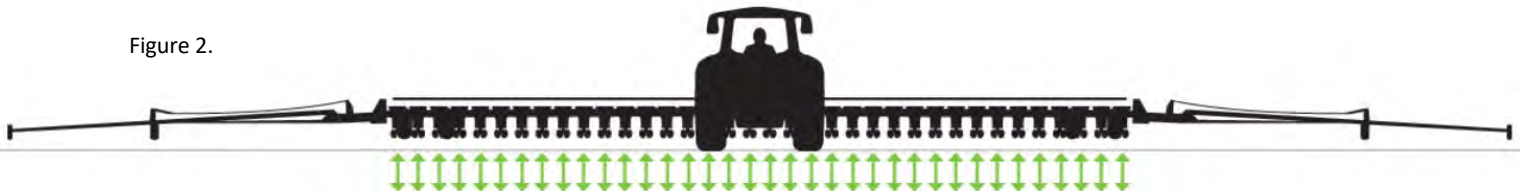

## DownForce Management Study Continued

**Results:** Table 1. illustrates the yield response of DeltaForce® automated control (Custom 120#) compared to excessive and light downforce settings. Too light of downforce (175# lift, 100# down) resulted in yield decreases of **-2.6 Bu/A.**, while excess downforce (550# down, 100# up) actually offered a small yield increase of +1.1 Bu/A.

Table 2. reveals the economics of the automated downforce system. Light downforce suffered the largest overall losses of **-\$10.72/A.**, while excess downforce resulted in a small gain of +\$4.64/A.

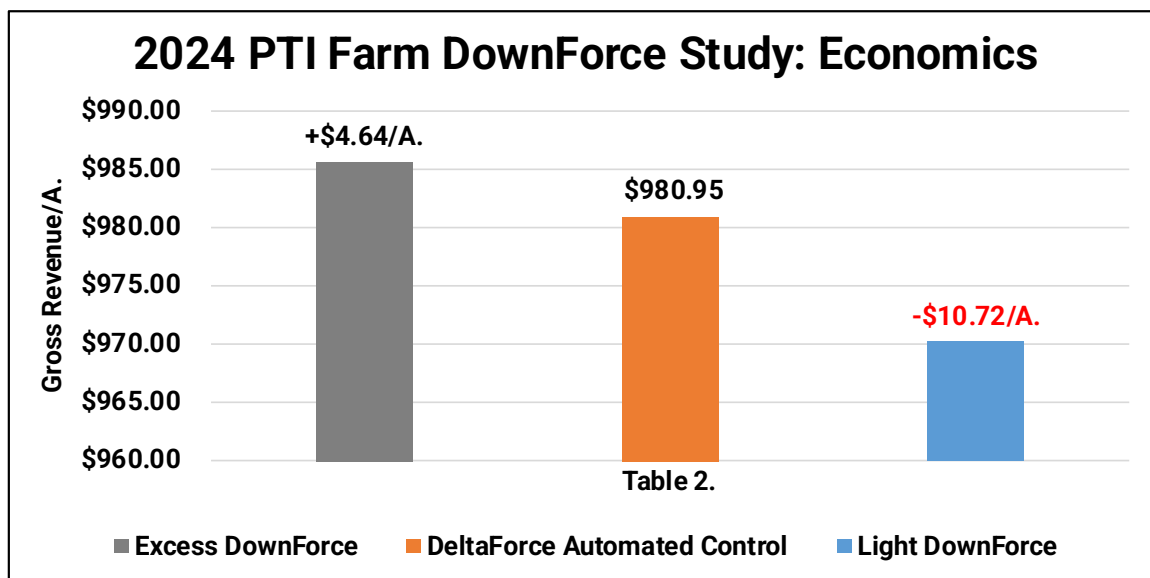
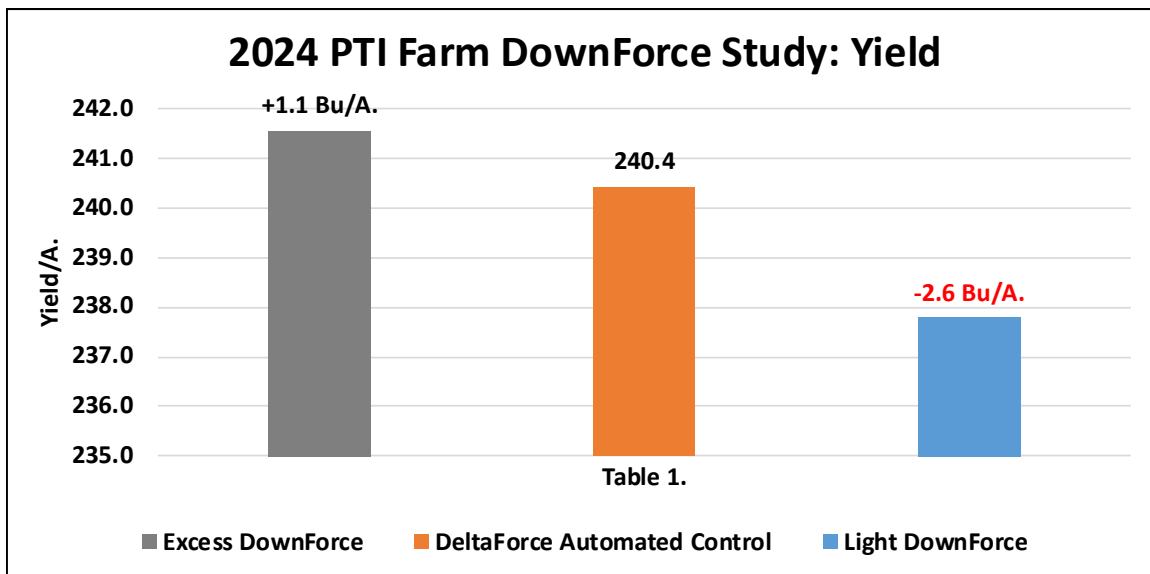

## DownForce Management Study Continued

Table 3. illustrates multi-year downforce yield results over the time-period of 2018 to 2024 at the Precision Planting PTI Farm. During these growing seasons, light downforce resulted in yield losses of **-12.7 Bu/A.** compared to automated control with a DeltaForce® system. Excess downforce resulted in losses as well, however at only **-4.8 Bu/A.**

Table 4. depicts the same multi-year time-period, but economics rather than yield. Over 2018-2024, light downforce resulted in economic losses of **-\$54.19/A.** and excess downforce of **-\$21.54/A.**

In summary, when downforce matches field conditions, the depth of planting is consistent and correct. By measuring with the DeltaForce® system, farmers can react and take control to ensure proper downforce and eliminate yield and economic losses.

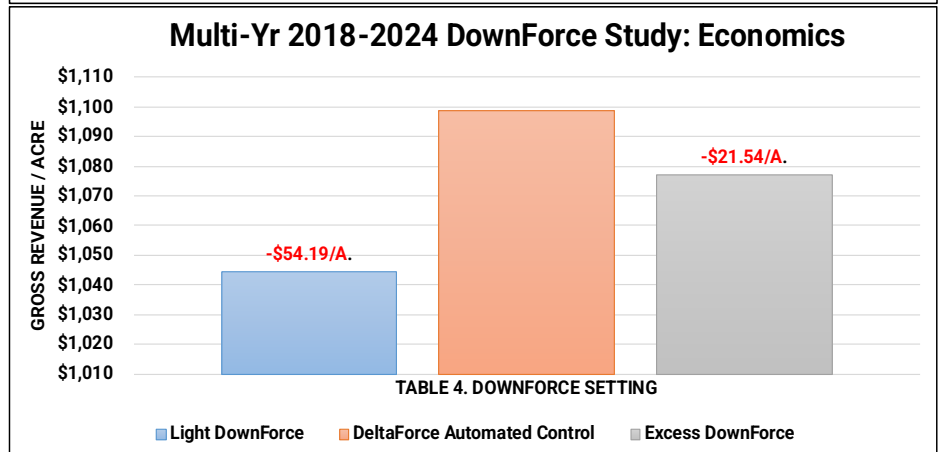
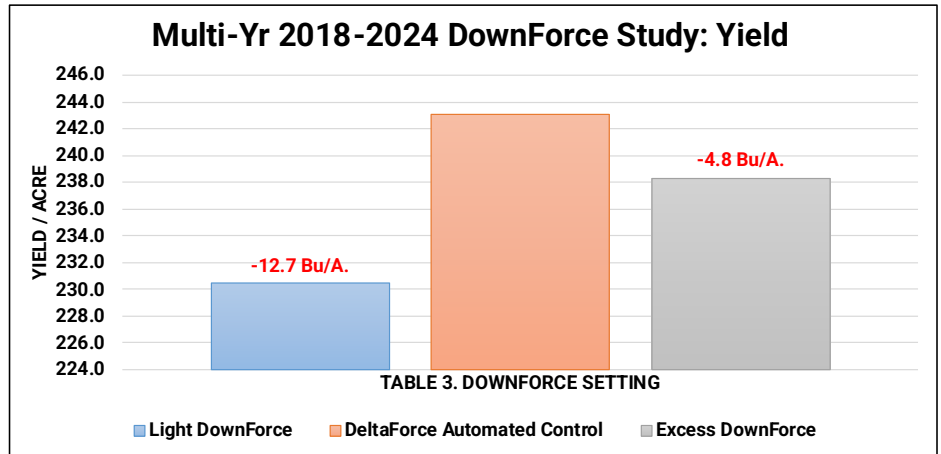

Planting Date: May 25<sup>th</sup>    Hybrid: GH 12U11    Population: 36K    Row Width: 30"    Rotation: CAB    Corn Price: \$4.08

## Planter “All Wrong Study”

**Objective:** This planter trial is designed to simulate yield and economic effects when a grower gets downforce, residue manager settings, and singulation incorrect on the planter, all at the same time. For this study we implemented light downforce, “goof” plates to achieve 95% singulation, and removed the use of residue managers.

**Results:** Table 1. reveals “All Wrong” planter settings caused average yield losses of **-15.6 Bu/A.** over the past four years. Table 2. calculates average economic losses of **-\$82.15/A.** when all three planter settings were incorrect. For more information on individual performance of these attributes, please see multiyear summary results for downforce management, residue management trials, and singulation studies.

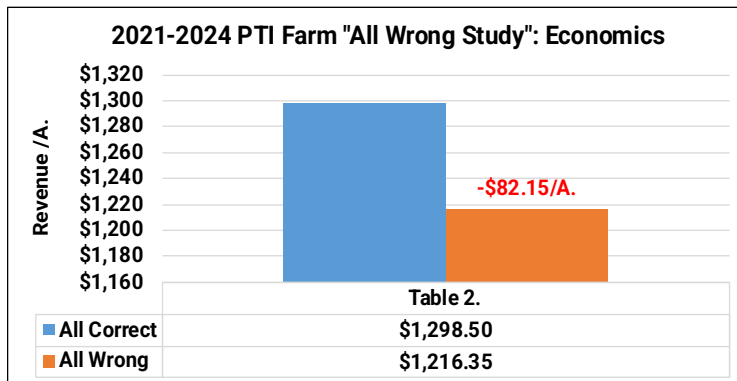
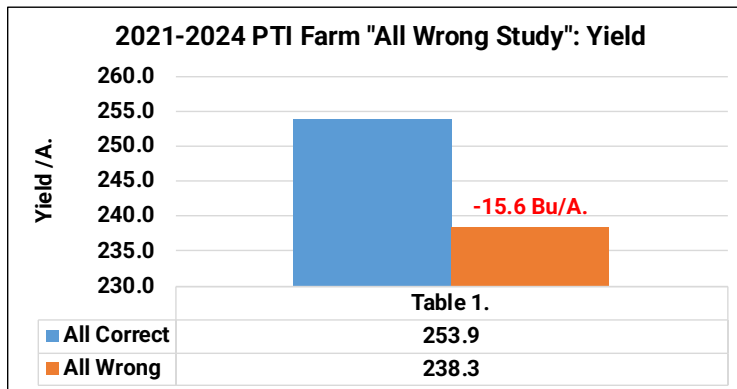

Planting Date: May 25<sup>th</sup>    Hybrid: Golden Harvest 12U11    Tillage: Strip-Till    Population: 36K    Row Width: 30"    Rotation: CAB    Corn Price: \$4.08

## Fendt® Momentum™ Load Logic Weight Mgt and Tire Inflation Study:

**Objective:** To evaluate the yield benefit of AGCO’s Fendt® Momentum™ planter, equipped with a Load Logic System. In 2020, AGCO released the all-new Fendt® Momentum™ planter equipped with key agronomic features to help alleviate pinch row compaction. One of those key features is the Load Logic system that includes hydraulic weight distribution and a tire pressure control system. Load Logic uses load cells to determine the available weight per tire, adjusting to weight distribution hydraulically across the entire planter and tractor.



In this study, we compare four different modes on the planter and tractor.

1. Automatic Weight Management + Automatic Low Tire Pressure
2. Automatic Weight Management + High Tire Pressure
3. Weight Management OFF + Automatic Low Tire Pressure
4. Weight Management OFF + High Tire Pressure

**Results:** Table 1. illustrates the Load Logic Automatic Weight Management + Tire Inflation system achieved agronomic optimum yield at 275.6 Bu/A. Highest yield losses of **-17.4 Bu/A.** with net losses of **-\$71.02/A.** occurred when the Automated Load Logic Weight Management + Tire Inflation system was turned off resulting in high tire pressures. When we break down how much each feature contributed to the total yield loss, the Load Logic tire inflation, so tire pressure alone impacted yield losses by +13.0 Bu/A. and net gains of +\$53.07/A., compared to high tire pressure.

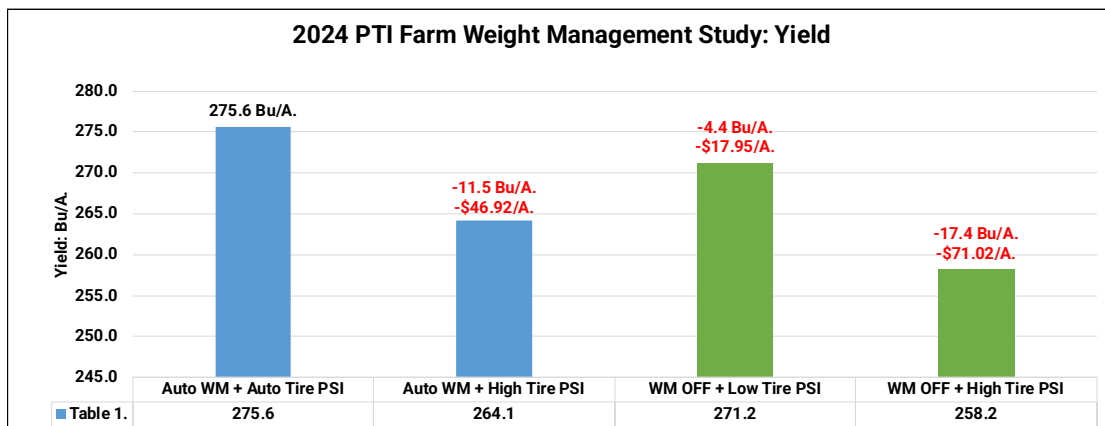

Planting Date: May 10<sup>th</sup>    Hybrid: DKC65-95    Tillage: Strip-Till    Population: 36K    Row Width: 30"    Rotation: CAB    Corn Price: \$4.08



## Traffic Management Study:

**Objective:** To evaluate the yield and economics of wheel traffic patterns. With every equipment pass made, growers have the opportunity to create compaction, soil density issues, and potentially lower yields. Compounded with the problem of harvesting equipment not having the ability to measure row-by-row yield, this studies goal is to identify the wheel traffic and measure the yield loss in those individual rows.

For this study, we use our current width of equipment that we operate at the PTI Farm.

- 40' 30" Fendt® Momentum™ Planter
- 40' Side-Dress Bar
- 90' Hagie™ Sprayer
- 20' 30" Capello Chopping Corn Head
- 20' 30" Kuhn® Krause® Gladiator® Strip-Till Bar



**Results:** Wheel traffic was accounted for on 91% of all rows in the field, meaning that only 9% of the field had no wheel traffic. Table 1. illustrates that wheel traffic rows resulted in average yield losses of **-16.5 Bu/A.** As this is the first of a ten year study, we look forward to evaluating this in the future to better understand and measure wheel traffic and how we can potentially manipulate equipment width to minimize the amount of wheel traffic.

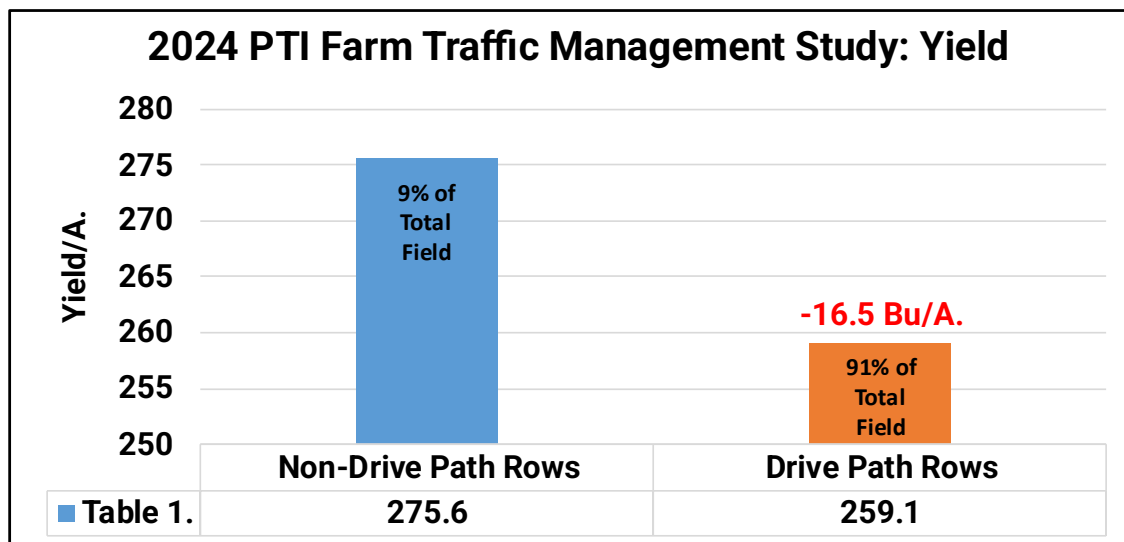

Planting Date: May 10<sup>th</sup>    Hybrid: DKC65-95    Tillage: Strip-Till    Population: 36K    Row Width: 30"    Rotation: CAB    Corn Price: \$4.08

## mSet® Multi-Genetic Planting Study

**Objective:** To analyze the yield and economic benefit of implementing mSet® single meter multi-genetic technology to place specific corn hybrids for individual spatial management zones.

mSet® is an upgradeable product to vSet® meters and vDrive® controller, which couples a seed selector added to the hopper to switch hybrids, and a seed pool level sensor in the meter (Figure 1.) The level sensor tells the seed selector when the meter needs more seed, and it drops a dose of seed into the meter. This continually happens until it is time to switch hybrids. At hybrid change, the level sensor will let the seed pool run low, then call for a dose of the other hybrid to enter the meter just in time for the change, leading to a short transition between hybrids. The seed pool is controlled by the mSet® selector (Figure 2.), providing the correct hybrid in the meter, and allowing the vSet® meter to accurately singulate those seeds. The ultimate result is the hybrid you select, planted in the area of the field you select, planted with highest accuracy of singulation. Additionally, for those who want to both plant fast, and place hybrids by spatial zone variability, SpeedTube® system can be used in tandem with multi-genetic technology (Figure 3).

Figure 1. mSet® Box

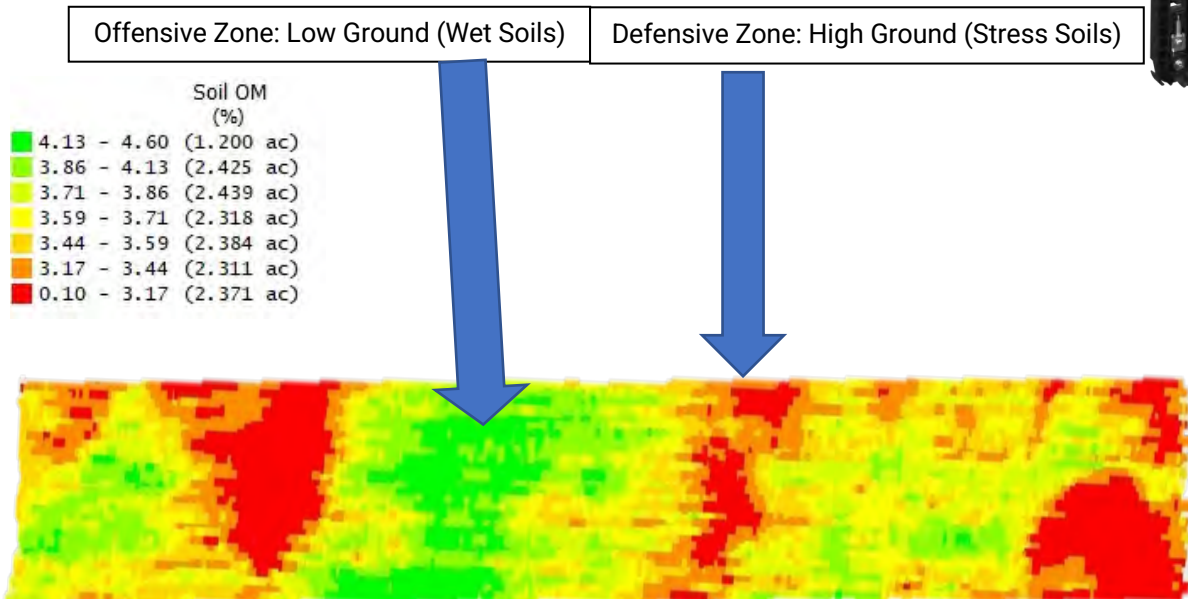

Figure 3. Speedtube®



Figure 2. mSet®

Figure 4. Offensive and Defensive Spatial Zones



## Multi-Genetic Planting Study Continued

**Results:** For this spatial study, DeKalb 66-06 Trecepta was used as our offensive corn hybrid in the lower elevation, higher OM, but potentially saturated soils. Conversely, Pioneer 14376Q was used as the defensive hybrid planted into the higher ground, lower OM, and potentially droughty soils. Each genetic package was placed into the appropriate matching spatial management zone (Figure 4). Test blocks were planted to evaluate the yield performance when hybrids were placed correctly, as well as incorrectly.

Figure 5. illustrates the results of multi-hybrid planting in 2024. Correct hybrid placement in the defensive zones resulted in yield gains of +15.1 Bu/A. and corresponded to an economic advantage of +\$61.61/A. Alternatively, correct placement in the offensive zones resulted in yield gains of +4.6 Bu/A. with increased revenue of +\$18.77/A.

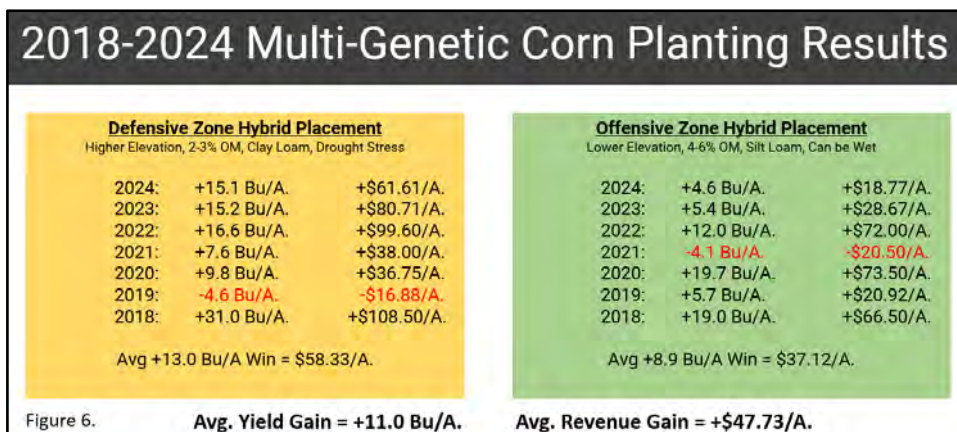
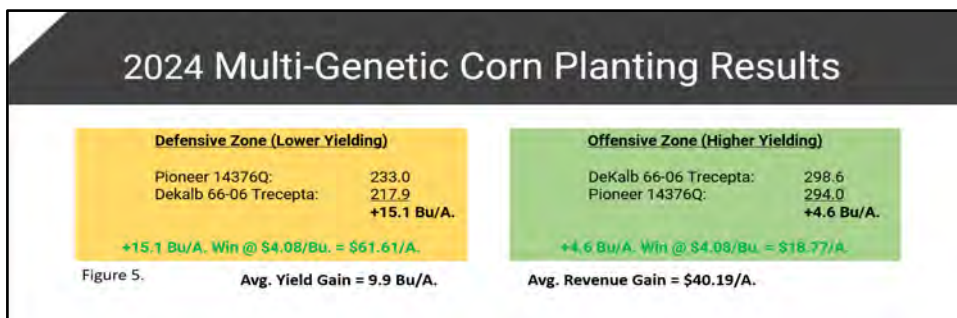

Figure 6. summarizes multi-genetic corn planting performance over the seven-year time period of 2018-2024. During this timeframe, multi-genetic corn has offered increased yield gains of +11.0 Bu/A. with additional farm revenue of +\$47.73/A. in increased revenue. In each zone placement over the last 7 years, only once was the placement incorrect. This track record would suggest an 85.7% success rate for choosing the optimum hybrid placement over 2018-2024 for each high/low yield zone.

Based on this multi-year data, if a grower invested \$1000/row on a 16-row planter for multi-hybrid technology, these types of yield and economic gains could result in return on investment at only 335 acres. These yield results confirm that a multi-genetic system can offer yield advantages and potentially large economic gains if used properly. For this system to work, growers and seedsman need to work together to place the appropriate genetics on the correct acre and planted at suitable seeding rates.

## Seed Orientation Study

**Objective:** To study the emergence timing of corn when altering at-plant seed orientation. Figure 1. illustrates how a corn kernel embryo imbibes water and starts germination. Each corn kernel has an embryo on one side of the corn kernel. This embryo imbibes water, and the coleoptile begins its path to the soil surface for emergence. This study evaluates emergence timing differences of planting corn kernels in the furrow at planting in two different seed orientations, “tip” down versus “tip” up. After planting, emergence was documented by flag testing in 12-hour increments to study the difference in emergence timing of each seed placement orientation.

Figure 1. Seed Orientation

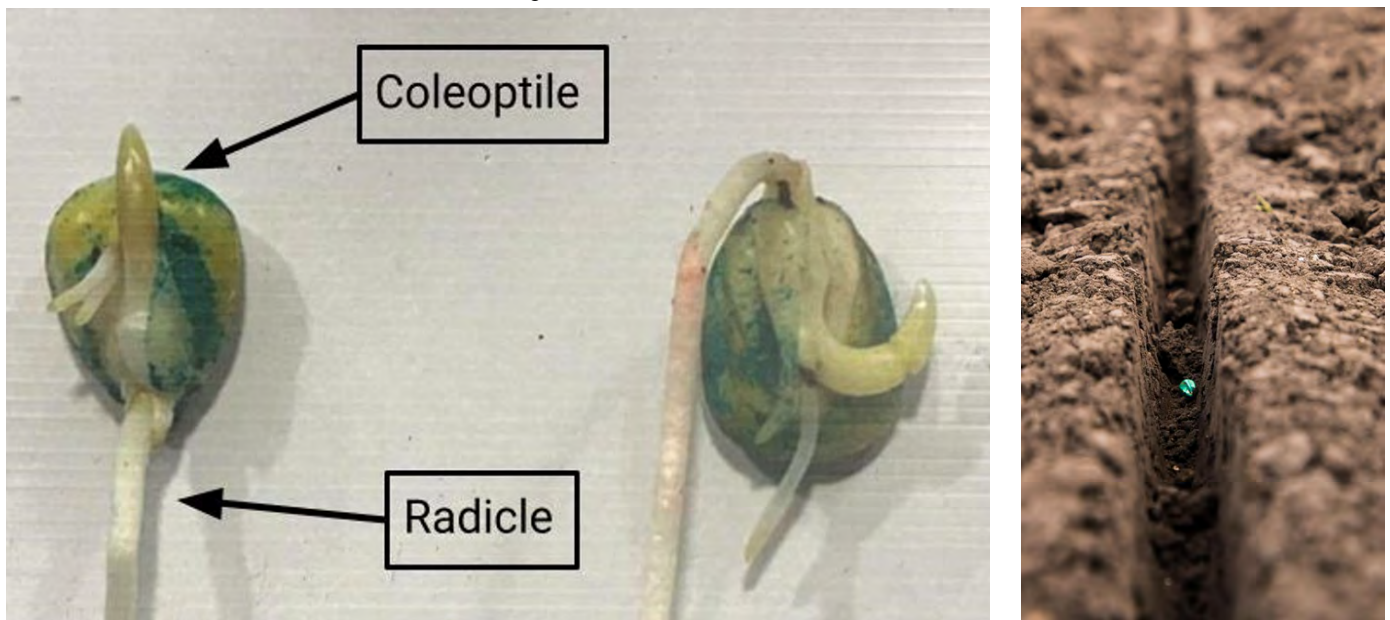
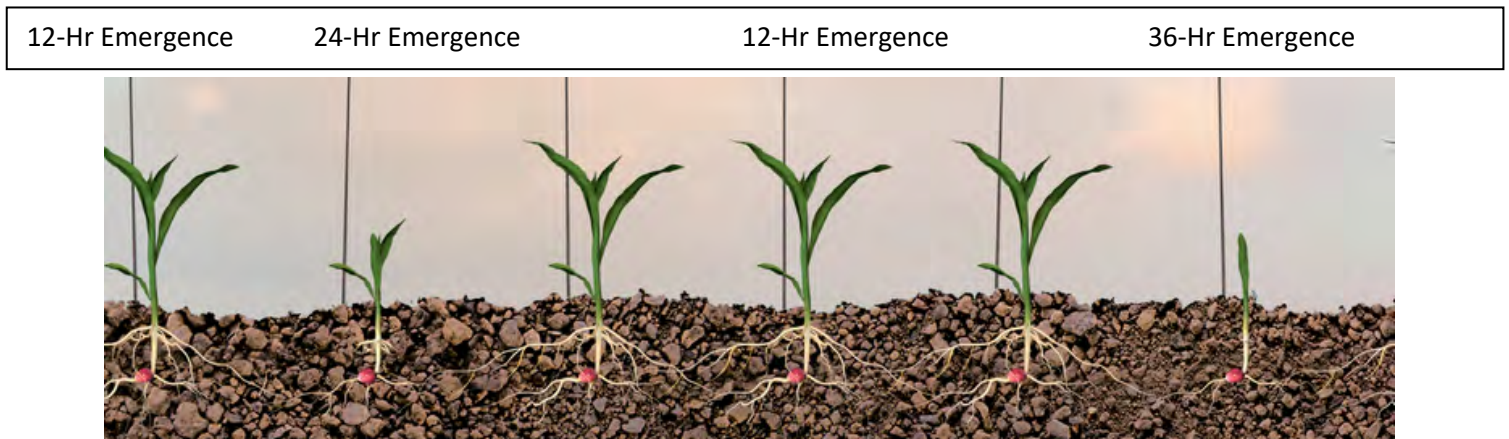

Figure 2. 12-Hr Increment Emergence Documentation



## Seed Orientation Study

**Results:** Figure 2. illustrates kernels oriented in a “tip” down placement resulted in uniform 99% 12-hour emergence and 1% in the later 24 hr. timing. However, seed oriented “tip” up resulted in non-uniform and slower emergence with 90% 12 hour, 5% at 24 hours and suffered 5% late emergers at 36 hours and later.

Kernels oriented “tip” up causes the coleoptile to grow downward upon initial germination, in other words growing the wrong direction. With time and vigor, the coleoptile will change direction and U-turn its way towards the soil surface. As emergence takes longer periods of time (especially with cold conditions), the result is a late emerging corn plant and a non-uniform stand.

Table 1. reveals multi-year corn emergence flag testing data over 2018-2024 that indicates corn plants emerging just 12 hours late (24hrs) suffer yield losses of **-13.5%**, while **-29.2%** at the 36-hour timeframe. Faster, more uniform emergence can eliminate these losses to maximize yield and to limit losses.

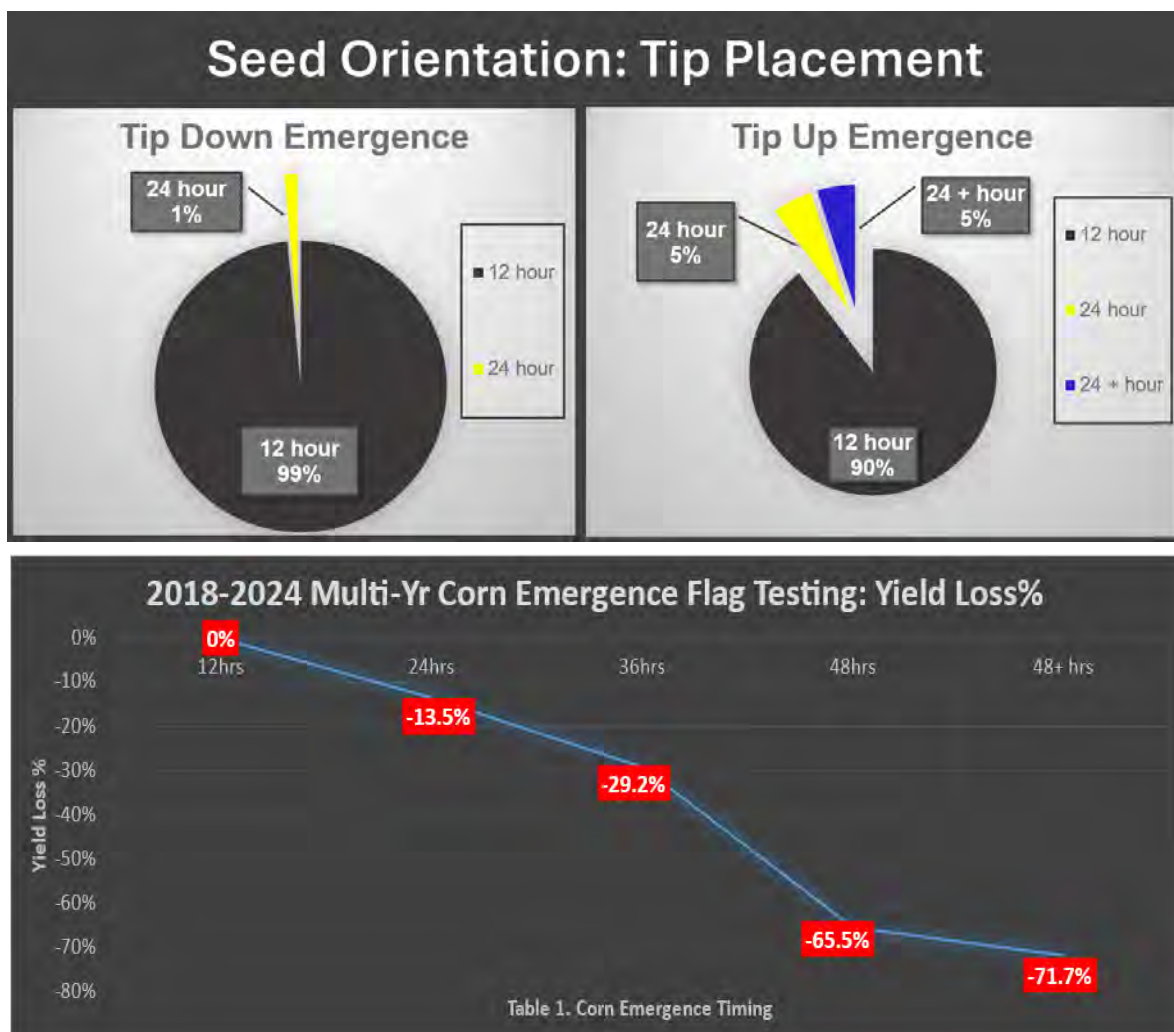

## Corn Leaf Orientation Study

**Objective:** To study corn leaf orientation within the row and understand the relationship of yield impact of corn leaves being positioned parallel or perpendicular to the row (Figures 1-2). Correct leaf orientation offers benefits of increased light interception, less sunlight to encourage weed suppression, cooler in-canopy temperatures, and moisture preservation.

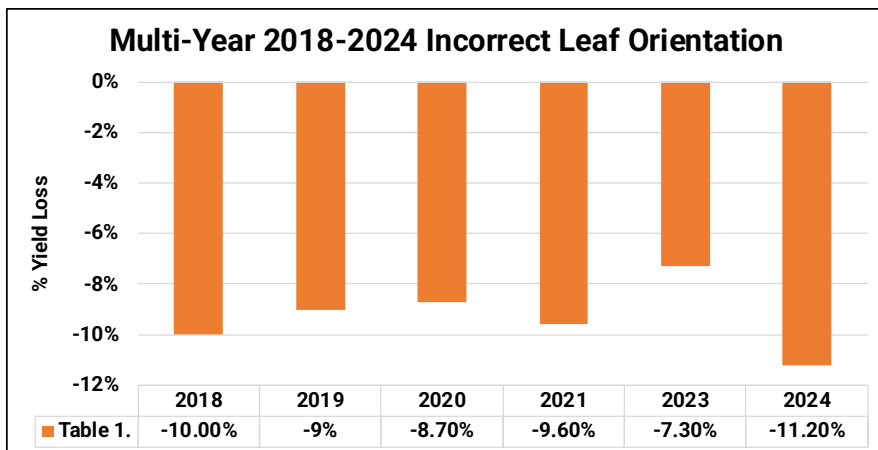

Figure 1. Correct Leaf Orientation



Figure 2. Incorrect Leaf Orientation

**Results:** Table 1. illustrates the multi-year results of yield checks at the PTI Farm from 2018 to 2024. Individual ear weight loss associated with incorrect leaf orientation resulted in **-11.2%** yield loss. Table 2. depicts average yield losses of **-18.6 to -23.3 Bu/A.** for each plant with wrong leaf orientation. However, the occurrence factors of these incorrectly oriented plants generally range from 20% to 30% of all plant populations. Therefore, actual yield losses from incorrect orientation range from **-3.7 to -7.0 Bu/A.** depending on overall actual corn yield average.



Now the big question is what is the solution to this agronomic challenge? In general, seed tip directional placement in-furrow has improved emergence timing, with minimal benefit to leaf orientation. Some research has indicated that embryo directional placement potentially may impact and improve leaf orientation.

2018-2024	Table 2.	Occurrence Factor Percentage		
Overall Corn Yield	Yield Loss	20% Wrong	25% Wrong	30% Wrong
200	<b>-18.6 Bu/A.</b>	<b>-3.7 Bu/A.</b>	<b>-4.7 Bu/A.</b>	<b>-5.6 Bu/A.</b>
225	<b>-20.9 Bu/A.</b>	<b>-4.2 Bu/A.</b>	<b>-5.2 Bu/A.</b>	<b>-6.3 Bu/A.</b>
250	<b>-23.3 Bu/A.</b>	<b>-4.7 Bu/A.</b>	<b>-5.8 Bu/A.</b>	<b>-7.0 Bu/A.</b>

## 15" Narrow Row Corn Seeding Rate Study

**Objective:** This trial evaluates a narrow system of 15" rows with eight seeding rates of 28K, 32K, 36K, 40K, 44K, 48K, and 52K.

**Results:**

Yields were excellent in this 15" corn dryland experiment with yields averaging 281.6 Bu/A. Agronomic optimum yield occurred at the 48K seeding rate at 285.6 Bu/A., however, yields only varied up to **-7.6 Bu/A.** overall entries. Seeding rates of 40-44K performed very similar to the optimum, with corn yield within **-1.1 to -1.9 Bu/A.** Lower seeding rates at 36K, 32K, and 28K proved highest yield losses ranging from **-4.8 to -7.6 Bu/A.** Pushing seeding rates higher to 52K resulted in reduced yields of **-5.6 Bu/A.**



The real story in this study resides in economics. Even though highest yield occurred at 48K, the economic optimum seeding rate occurred at the lowest seeding rate of 28K. After accounting for seed cost of \$350/bag, each 4K seeding rate needed a +4.3 Bu/A. yield increase to break-even. Since there was only a 7.6 Bu/A. range over the whole study, high seeding rates did not offer positive economic gains. Seeding rates of 32K to 40K proved losses ranging from **-\$19.95 to -\$28.22/A.**, 44K to 48K seeding rates offered losses of **-\$48.99/A.** to **-\$58.94/A.** and the highest seeding rate of 52K proved losses of **-\$99.29/A.**

In conclusion, overall yield was fantastic in this 15" row width platform, however higher seeding rate did not offer economic advantages. This is the result of deficit rainfall during the growing season of -6.58" of rain.

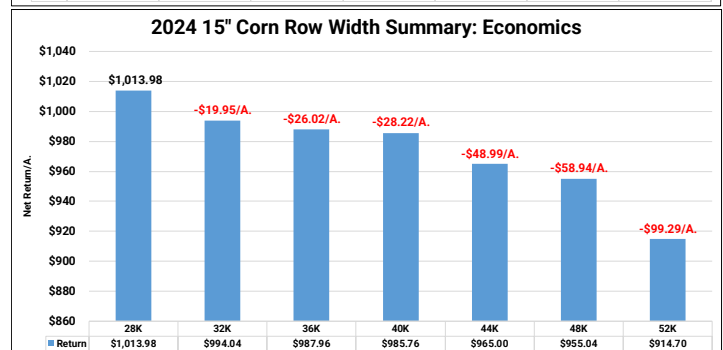
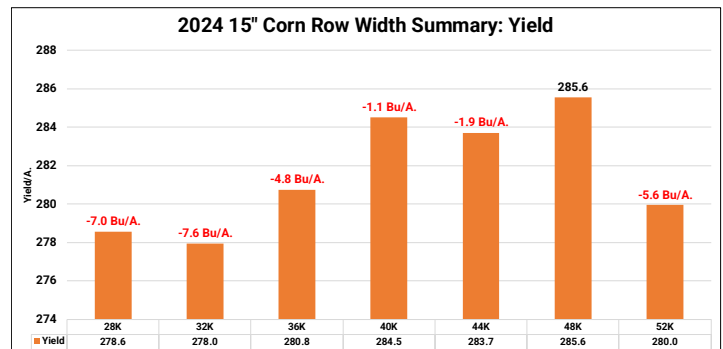

## 20" Narrow Row Corn Seeding Rate Study

**Objective:** This trial evaluates a narrow system of 20" rows with eight seeding rates of 28K, 32K, 36K, 40K, 44K, 48K, and 52K.

**Results:** Yields were excellent in this 20" corn dryland experiment with yields averaging 268.9 Bu/A. Agronomic optimum yield occurred at the 36K seeding rate at 275.5 Bu/A., however yields only varied from **-2.5 to -6.1 Bu/A.** with higher seeding rates of 40K, 44K, and 48K. Lower seeding rates at 32K and 28K proved losses ranging of **-9.0 to -14.3 Bu/A.** Pushing seeding rates higher to 52K resulted in reduced yields of **-11.4 Bu/A.**

As for economics, 36K was also economic optimum. As seeding rates were lowered to 32K and 28K, economic losses of **-\$19.22 to -\$23.14/A.**

Increasing seeding rate to 40K resulted in losses of **-\$27.70/A.,** 44K to 48K absorbed significant losses of **-\$59.89 to -\$65.15** and the highest seeding rate of 52K proved largest losses of **-\$116.51/A.**

In conclusion, overall yield was satisfactory in this 20" row width platform, however 36K seemed to be the sweet area for 2024. With a growing season that provided a deficit of -6.58" of rain, it seems logical that higher seeding rates could suffer significant losses.

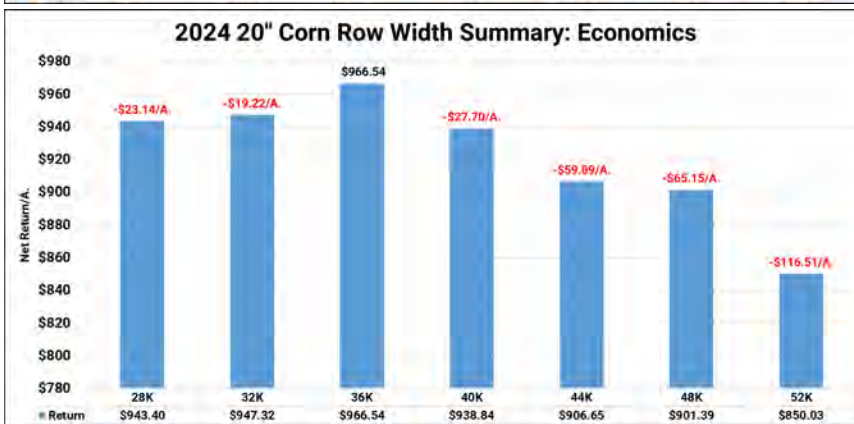
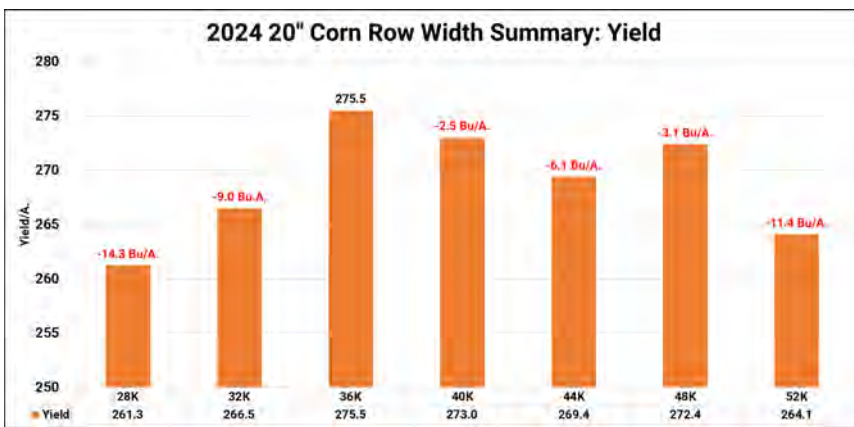

Planting Date: May 3<sup>rd</sup>    Hybrid: GH 15J91, DKC 64-22VT2R0    Population: Varied    Row Width: 15"    Rotation: CAB    Corn Price: \$4.08    Seed: \$350/Bag



## Multi-Year Narrow Corn Row Width Study

Each year we have thousands of growers that come to the PTI Farm to have a conversation about agronomics. One question we talk about often is corn row width. Many farms today that are on 30" corn rows, say they switched from wide 38" or 36" wide rows back in the early 70's. If this is the case, growers have been implementing 30" row corn systems for nearly 50 years. The question now is, has 50 years been long enough doing the same thing over and over, or is time now for a change to another system that could offer higher yields and profitability?

The question comes down to this; What revenue gain would cause a farmer to feel the need to convert their farming operation and over-all management to narrow row corn and switch away from the industry status quo of 30" rows?

Table 1. illustrates multi-year data over the time-frame of 2019-2024 and reveals 20" rows offering an overall economic advantage of +\$31.64/A. compared to 30" rows planted at 36K seeding rates.

Table 2. illustrates multi-year data over the time-frame of 2022-2024 and reveals 15" row corn offering highest economic advantages of +\$51 to \$57/A compared to 30" rows at 36K seeding rates.

PTI Farm data suggests that both 20" and 15" rows have proven economic optimum gains at 40K seeding rates. However, 15" rows are averaging overall gains +\$25.66/A. to that of 20" rows.

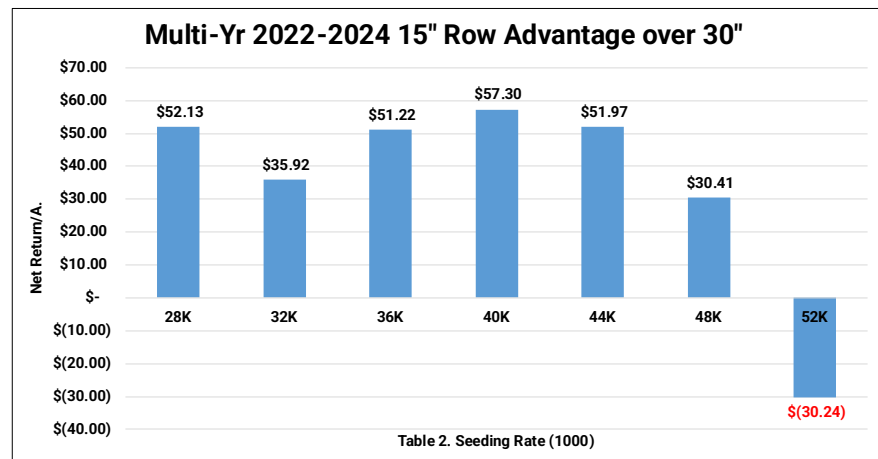
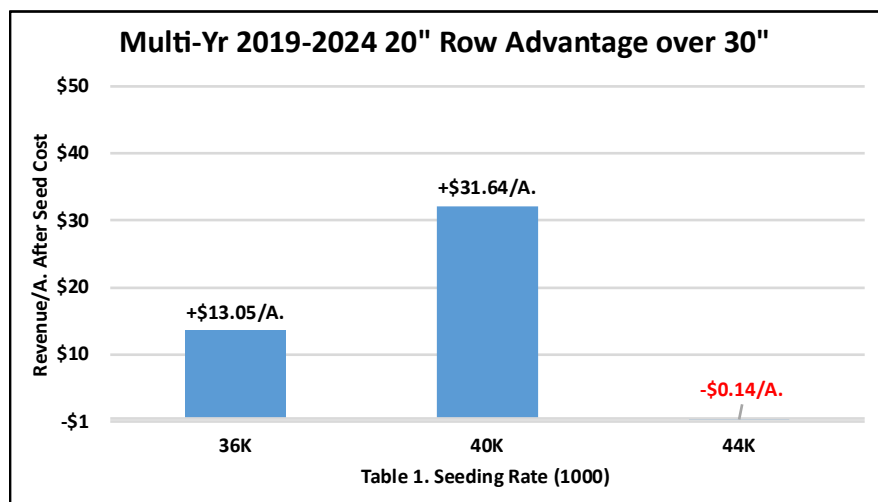

## 15" Narrow Row Corn Nitrogen Placement Study

**Objective:** This study evaluates the yield and economic impact by adding at-plant nitrogen in narrow row 15-inch corn.

For many growers, nitrogen management may be difficult in narrow row corn due to row width, tire size, and equipment. As a result, some growers say that nitrogen will have to be applied upfront and will not implement side-dress or planter applications.

This study evaluates various programs to help improve nitrogen management in narrow 15" corn rows by evaluating the following four nitrogen programs:



1. 100% Weed-N-Feed
2. 50%N 32% UAN Weed-N-Feed + 50% N at-plant Conceal®
3. 50% N 32% UAN Weed-n-Feed + V10 50% N EZ-Drops™ Side-dress
4. 25% N with 32% UAN Weed-n-Feed + 25% N Conceal® at-plant N + V10 50% EZ-Drops™ Side-dress

Figure 1. Weed-N-Feed Nitrogen



Figure 2. Conceal At-Plant Nitrogen



Figure 3. EZ-Drops™ Side-Dress



## 15" Narrow Row Corn Nitrogen Placement Study

**Results:** Single weed-n-feed applications resulted in lowest overall yield average, as well as net return.

Reducing weed-n-feed nitrogen by 50% and replacing it on the planter with dual band Conceal, contributed an additional +6.7 Bu/A. over weed-n-feed single treatments with net returns of +\$27.34/A.

Removing the at-plant nitrogen and replacing it with an EZ-Drops V10 side-dress added +4.4 Bu/A. However, due to the cost of the second trip, net return was only +\$1.95 over planter applied N.

At plant and V10 EZ-Drops side-dress application of nitrogen proved highest overall yields, with yield gains of +13.5 Bu/A. over single weed-n-feed placement and also resulted in highest overall net return of +\$39.08/A. Triple split proved returns of +\$9.79/A over EZ-Drops side-dress and \$11.74/A. over planter applied N.

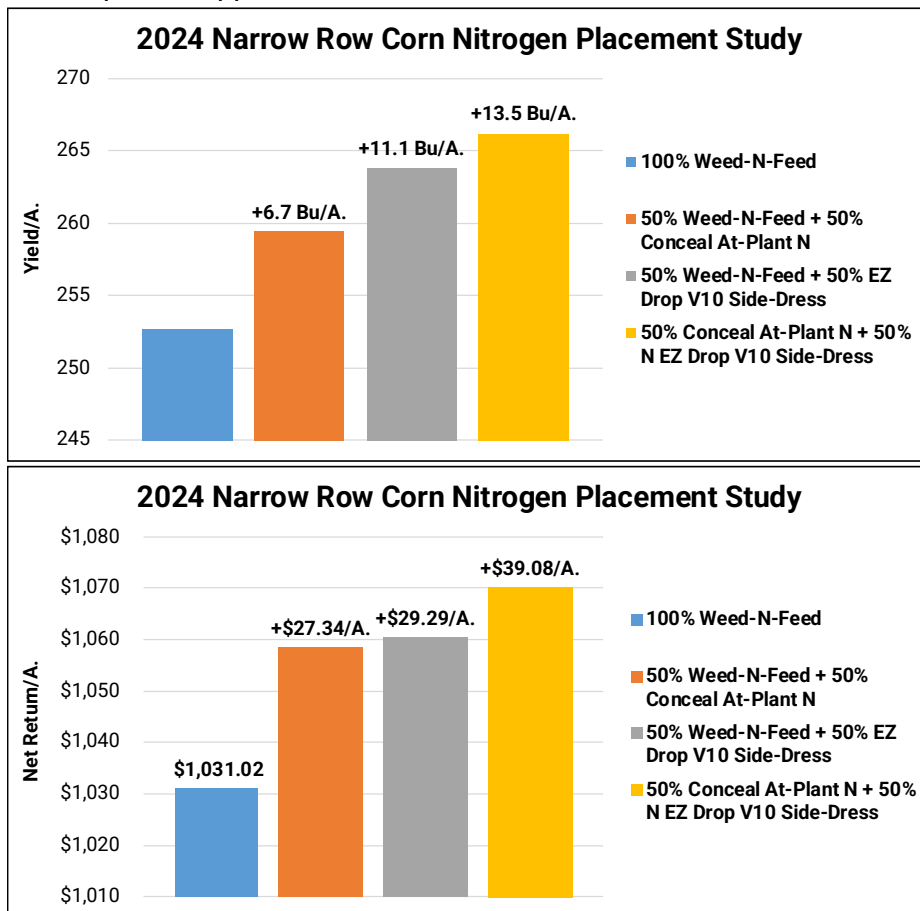

Planting Date: May 10<sup>th</sup>    Hybrid: Pioneer 1742, DKC 64-22    Population: 38K    Row Width: 15"    Rotation: CAB    Corn Price: \$4.08    Total N: 225#    App: \$16

## Fall Strip-Till and Urea Nitrogen Study

**Objective:** This study evaluates yield and economics of placing encapsulated slow release urea nitrogen in a fall strip-till band as part of sequential corn nitrogen program.

Nutrien's ESN® Smart Nitrogen, is a 44% controlled release dry-prill nitrogen, comprised of urea contained within a flexible polymer coating. This coating protects the nitrogen from loss mechanisms and releases nitrogen in response to soil temperature. ESN's polymer membrane allows moisture to diffuse into the granule, at a rate that is controlled by soil temperature and matches the nitrogen demand of the growing crop.

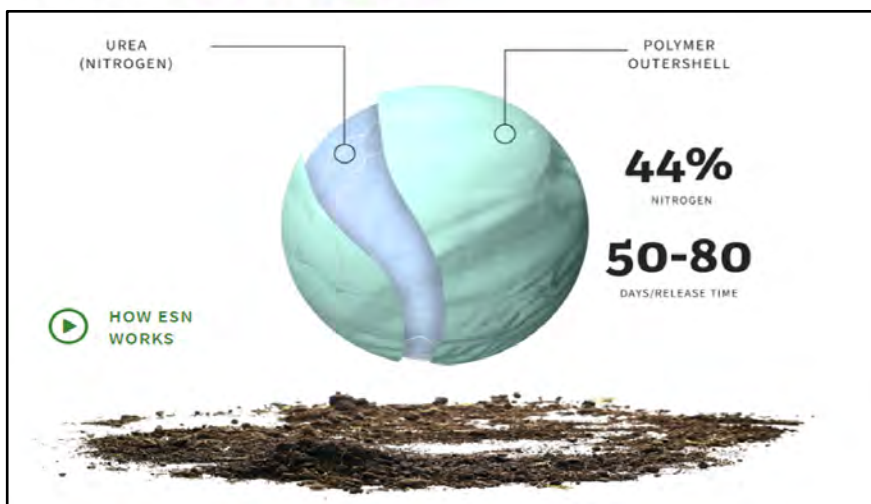

ESN Smart Nitrogen was applied at a rate 50# actual N, in a fall strip-till application at a placement depth of 8".

50# of N was then re-allocated to the spring nitrogen program, which consisted of:

- \*15 Gal 32% UAN as pre-emerge Weed-N-Feed

- \*15 Gal 32% UAN at-plant Dual Band Conceal

- \*20 Gal 32% UAN V5 Side-Dress (50# Less Side-Dress N in fall applied Urea Strips)



## Fall Strip-Till and Urea Nitrogen Study Continued

**Results:** ESN applications in fall strip-till bands contributed to +6.4 Bu/A. yield gains corresponding to a net return on investment of +\$21.05/A.

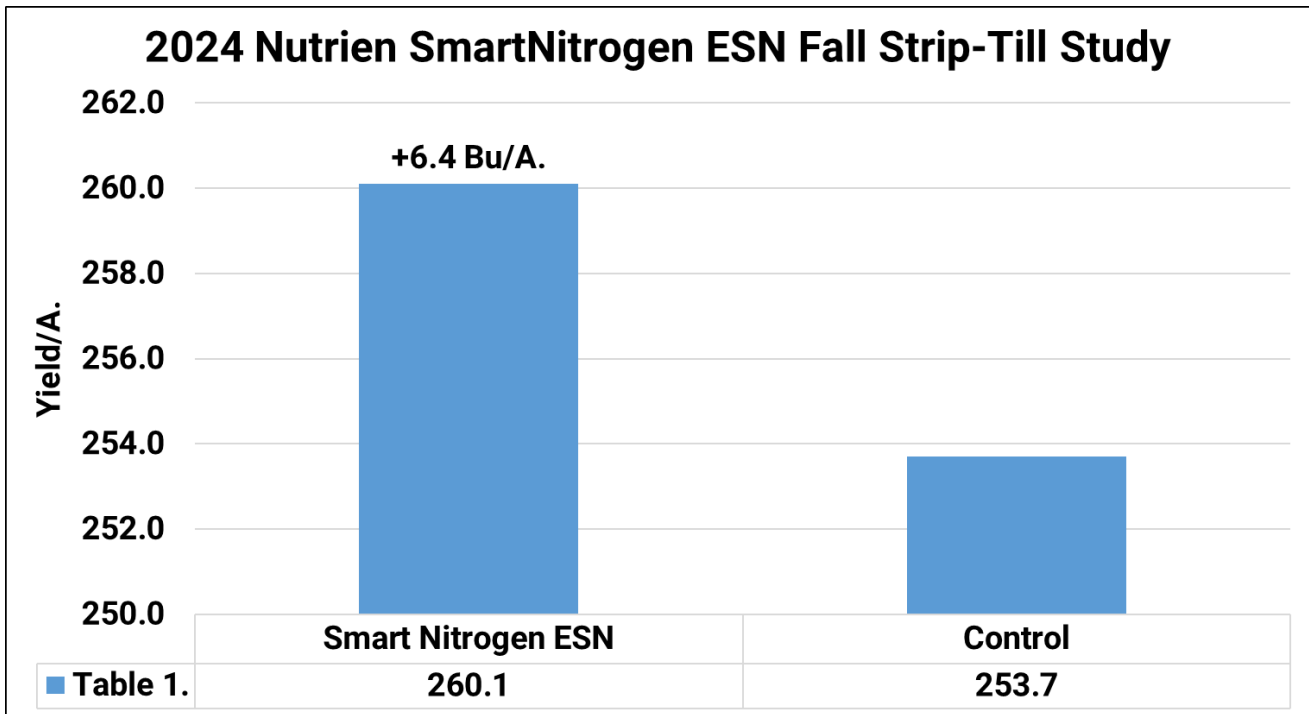

Planting Date: May 15<sup>th</sup>    Hybrid: Pioneer 13476Q    Population: 36K    Row Width: 30"    Rotation: CAC    Corn Price: \$4.08    UAN: \$0.58/#    ESN: \$0.68/#

## Preceon™ Short Stature Corn 30" Row Seeding Rate Study

**Objective:** To evaluate yield and economic impact of planting short stature corn hybrids in 30" rows, planted at seeding rates of 34K, 42K, and 50K.

Short stature corn is a new platform of corn that is designed to be significantly short in stature (Figure 2.) in order to have increased tolerance to lodging and green snap. Overall plant height is shortened due to node "stacking" from ear placement to the soil surface (Figure 1). Shorter height also allows for more flexible timing and the ability to use ground application of other crop inputs, like fungicides, insecticides and nitrogen.



Due to improved plant standability, short corn can allow farmers to explore higher planting densities, providing the potential to produce more on every acre. This study's goal is to help determine how the yield potential and economic impact of typical 34K seeding rates, to that of higher rates of 42k and 50K.

Figure 1. Short Corn Node Stacking



Figure 2. Short Stature Corn Height Difference

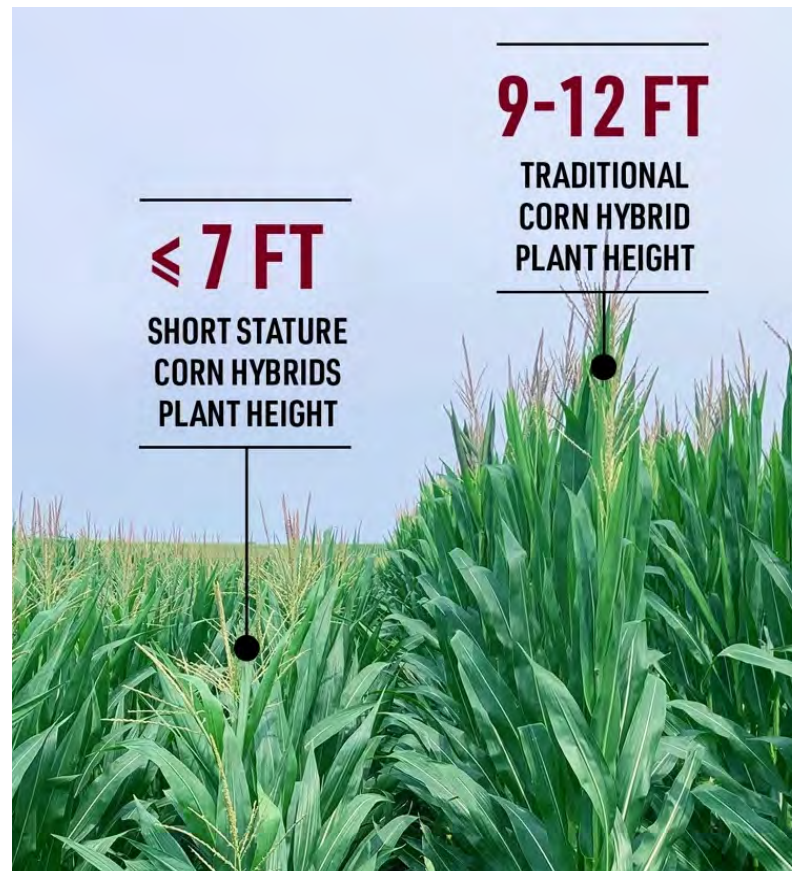

## Preceon™ Short Stature Corn 30" Row Seeding Rate Study

**Results:** PR106-21SS resulted in agronomic optimum seeding rate when planted in 30" rows at 36K seeding rates. Lower 34K seeding rates resulted in yield losses of **-11.3 Bu/A.** with economic losses of **-\$38.60/A.** Higher 38K and 40K rates proved yield losses as well at **-9.9** and **-11.1 Bu/A.** with corresponding revenue losses of **-\$47.89** to **-\$60.29/A.**

Due to improved plant standability, short corn could allow farmers to explore higher planting densities to obtain higher yields. However, a 30" row width in corn may hold a barrier to higher plant densities as plant to plant competition could cause too much stress, especially in drought conditions. Short stature corn planted at higher plant densities may be a better agronomic fit for narrow row corn.

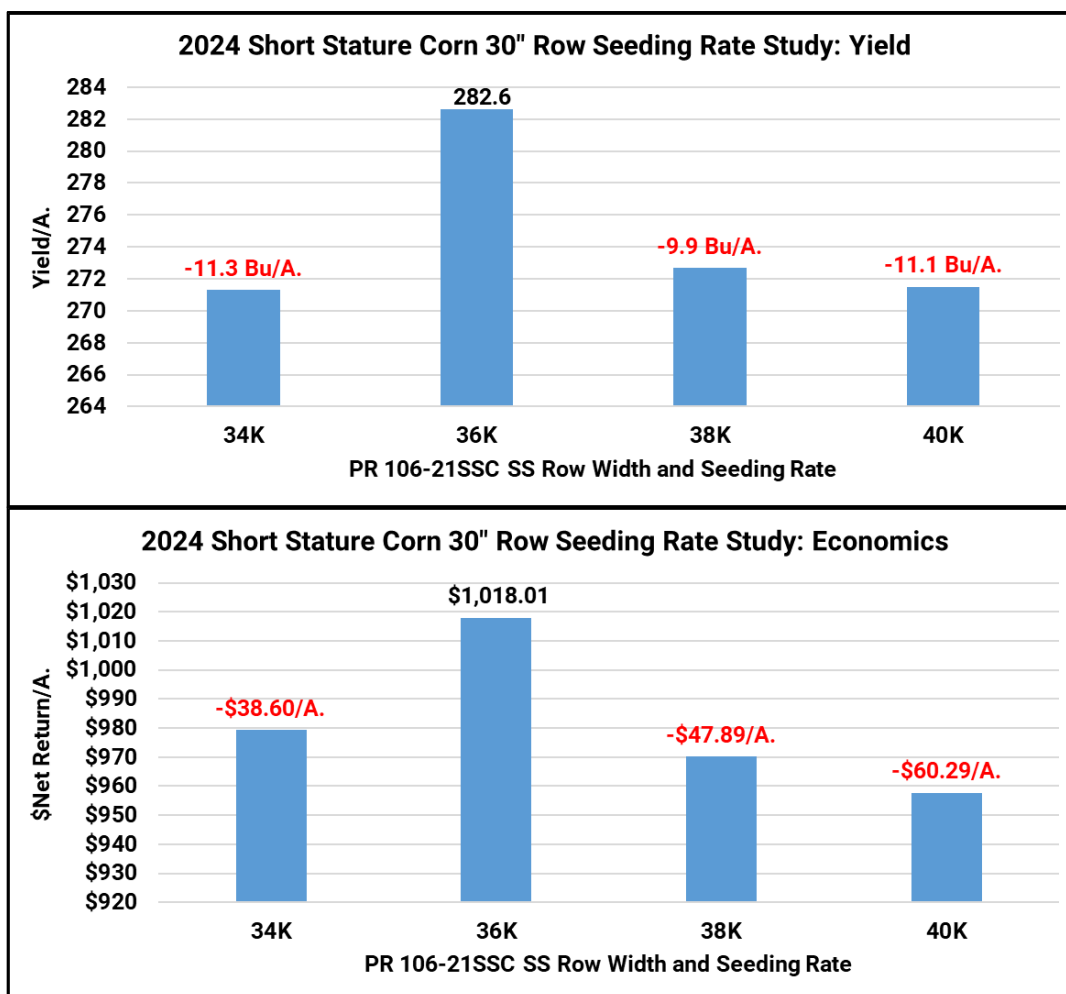

Planting Date: April 28<sup>th</sup> Hybrid: PR106-21SS Population: 34K, 36K, 38K, 40K Row Width: 30" Rotation: CAC Corn Price: \$4.08 Seed Cost: \$300/Bag

## Preceon™ Short Stature Corn Row Width/Seeding Rate Study

**Objective:** To evaluate yield and economic impact of planting short stature corn hybrids in both 30" and 15" rows, planted at seeding rates of 34K, 42K, and 50K.

Short stature corn is a new platform of corn that is designed to be significantly short in stature (Figure 2.) in order to have increased tolerance to lodging and green snap. Overall plant height is shortened due to node "stacking" from ear placement to the soil surface (Figure 1). Shorter height also allows for more flexible timing and the ability to use ground application of other crop inputs, like fungicides, insecticides and nitrogen.



Due to improved plant standability, short corn can allow farmers to explore higher planting densities, providing the potential to produce more on every acre. With 30" corn row width being the industry standard, this study's goal is to help determine how the yield potential and economic impact of short corn in wide row 30", compares to narrow row 15" corn at typical 34K seeding rates to that of higher rates of 42k and 50K.

Figure 1. 15" Row Width Corn



Figure 2. Industry Standard 30" Corn Row Width





## Preceon™ Short Stature Corn Row Width/Seeding Rate Study

**Results:** PR108-21VT2P resulted in economic optimum seeding rate (EOSR) when planted in narrow 15" rows at 42K seeding rates. Overall, 15" narrow corn out-performed 30" rows by +14.7 Bu/A. and when comparing the EOSR for each row width, 15" rows proved additional net returns of +\$51.60/A. 30" row width proved EOSR at the lowest seeding rate of 34K.

PR106-21VT2P also resulted in economic optimum seeding rate when planted in narrow 15" rows at 42K seeding rates. Overall, 15" narrow corn out-performed 30" rows by +13.2 Bu/A. and when comparing the economic optimum seeding rate for each row width, 15" rows proved additional net returns of +\$45.48/A. 30" row width also proved EOSR at the lowest seeding rate of 34K.

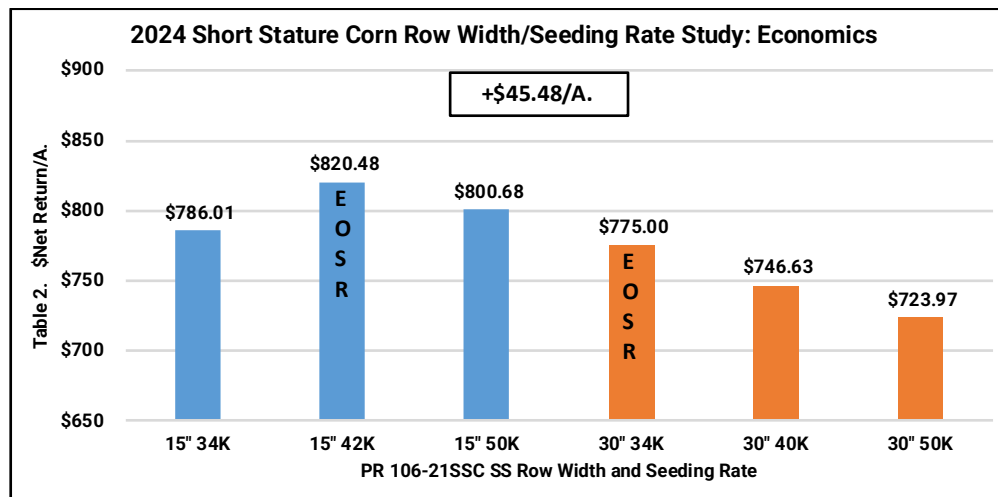
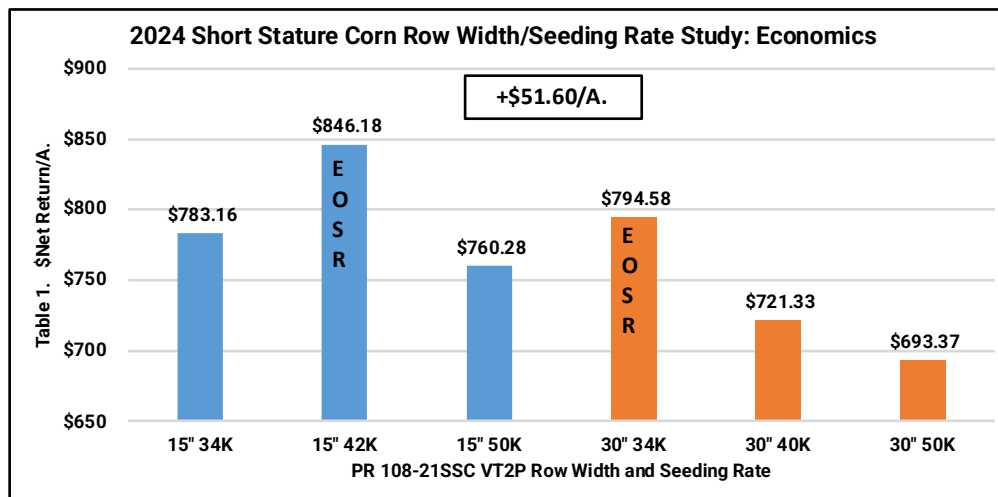

Planting Date: May 12<sup>th</sup> Hybrid: PR106-21SS, PR108-21VT2P Population: 34K,42K,50K Row Width: 30"/15" Rotation: CAB Corn Price: \$4.08 Seed Cost: \$300/Bag

## REVLINER® HOPPER THROTTLE™ Hopper Box Treatment Study

**Objective:** To evaluate yield and net return of REVLINER® HOPPER THROTTLE™, a talc/graphic/micronutrient planter box treatment.

HOPPER THROTTLE™ is an 80/20 talc/graphic blend for planters that also contains Manganese, and Zinc. It places essential nutrition, flow agents, and crop enhancement components directly on the seed to aid in singulation and improve seedling vigor and growth.

**Results:** HOPPER THROTTLE™ hopper box treatments offered average yield gains of +3.6 Bu/A. with a Positive net return on investment of +\$1.69A.

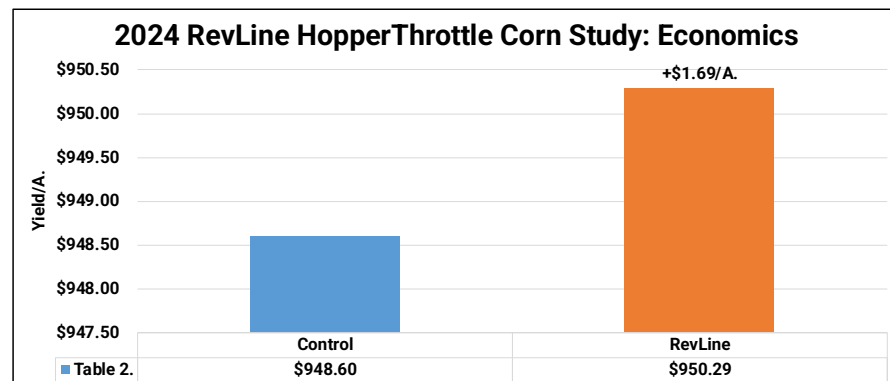
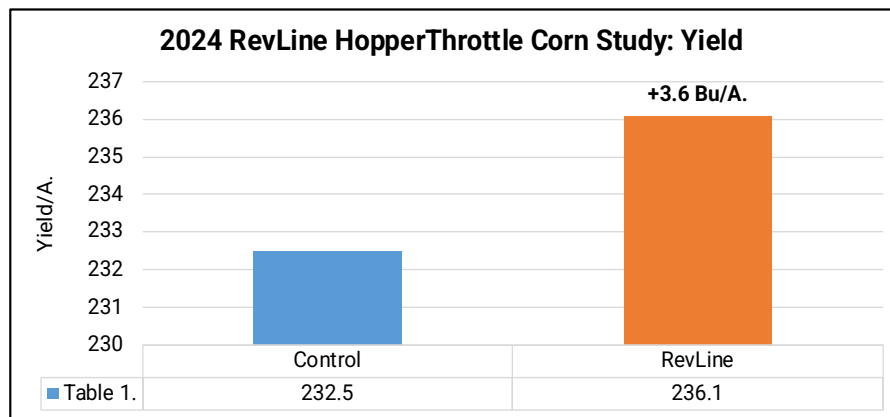
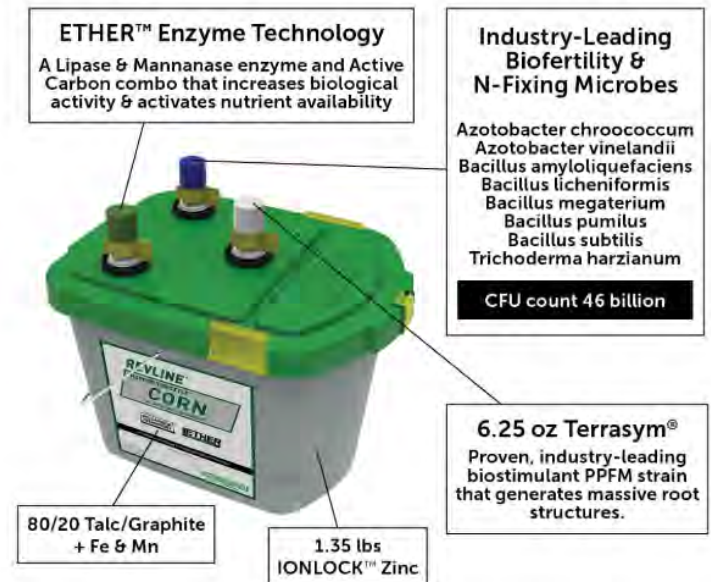

Planting Date: May 10<sup>th</sup> Hybrid: GH 15J91 Population: 26K Row Width: 30" Rotation: CAB Corn Price: \$4.08 HOPPER THROTTLE: \$13.00/A. Talc/Graphite: \$0.15/A.

## NewFields Ag™ Bio-Stealth Hopper Box Study

**Objective:** To evaluate the use of Bio-Stealth with Provid-R PM compared to a traditional 80/20 Talc/Graphite seed lubricant. Bio-Stealth triggers the plants’ defenses when it’s applied to the seed, which in turn has a decrease in larva root feeding. When there is root damage due to feeding, Provid-R PM helps increase root regrowth.

Bio-Stealth with Provid-R PM helps improve seed lubrication and seed flow during planting and delivers improved nutrient uptake leading to robust early season root development, protect against larva feeding and increase root regrowth, enhanced tolerance of abiotic stress throughout the growing season, and higher yields at harvest.

**Results:** Hopper box treatments of Bio-Stealth with Provid-R PM resulted in yield gains of +2.4 Bu/A. over the control applications. At a \$4.08 corn commodity price and a product cost of \$14.75/A., economics netted **-\$4.81/A.**

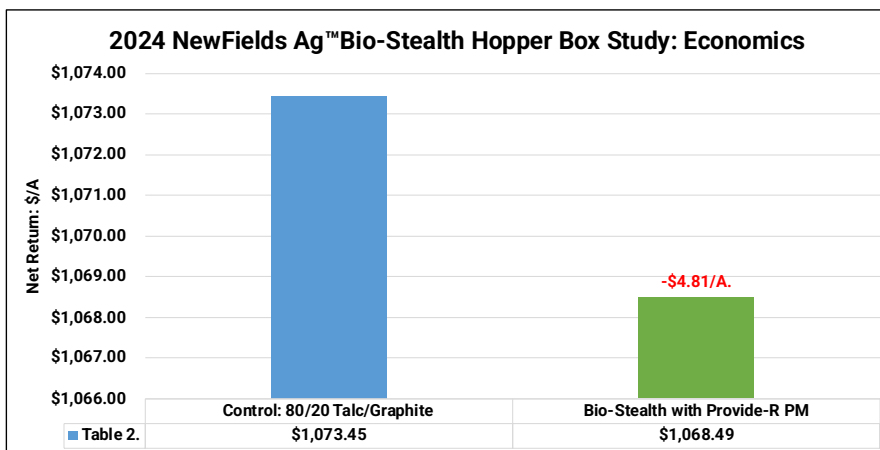
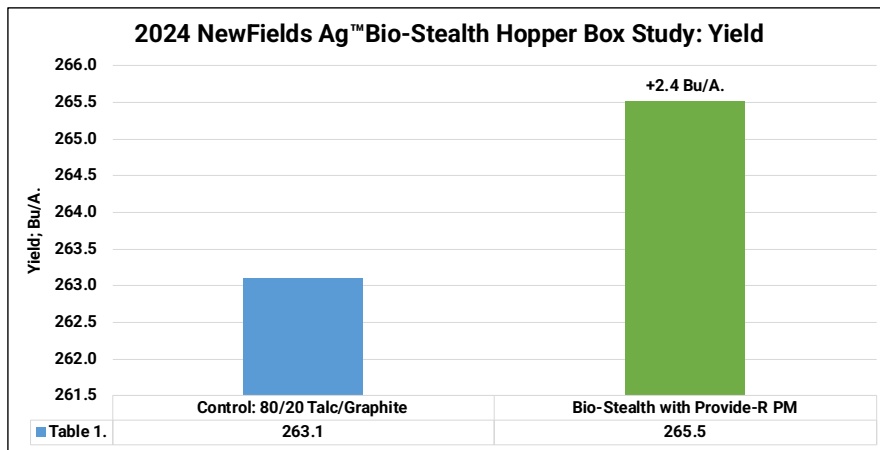

Planting Date: May 15<sup>th</sup>

Hybrid: DKC 59-82VTDoublePro  
Corn Price: \$4.08

Population: 36K  
Bio-Stealth with Provid-R PM : \$14.75/A

Row Width: 30"

Rotation: CAB

## SpeedWet Xion SiliconGel® Hopper Box Study

**Objective:** To evaluate the use of SpeedWet Xion SiliconGel® compared to a traditional graphite treatment. Xion SiliconGel® is an adjuvant product that we applied directly to the seed.

**Results:** Hopper box treatments of SpeedWet Xion SiliconGel® resulted in yield gains of +3.4 Bu/A. over the control applications. At a \$4.08 corn commodity price and a product cost of \$.10/A., economics netted +\$9.92/A.



## Green Lightning™

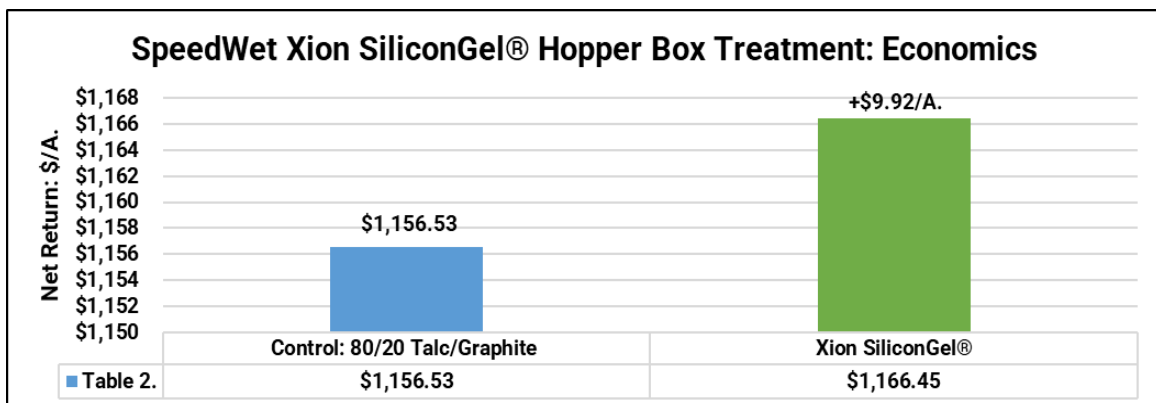
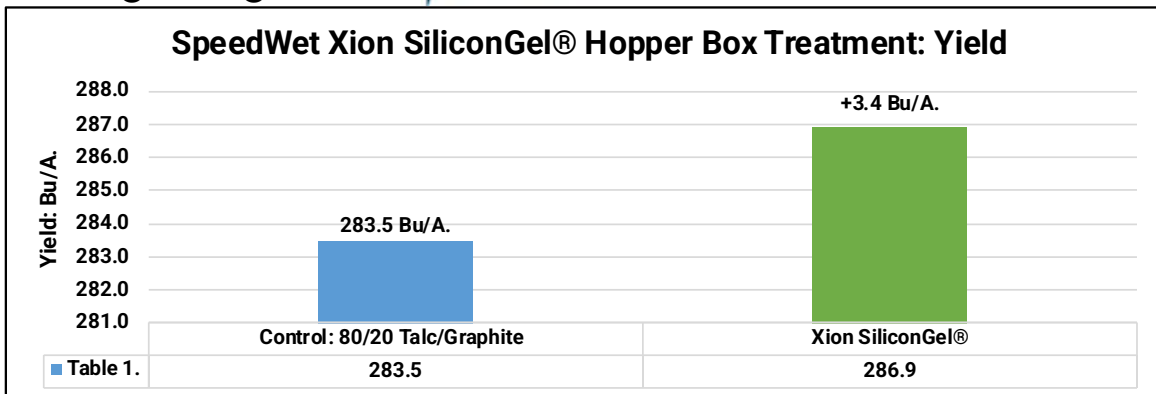

Planting Date: April 30<sup>th</sup>    Hybrid: GH030U8    Population: 36K    Row Width: 30"    Rotation: CAB    Corn Price: \$4.08    Xion SiliconGel®: \$.10/A.

## Plasma Activated Water Seed Treatment Study

**Objective:** To evaluate yield, and net return of Green Lightning plasma activated water used as a Seed Treatment. Green Lightning is a mechanism to replicate a naturally occurring process that leads to nitrogen. During a lightning storm, static electricity rearranges the nitrogen molecule in the air, and this modified molecule is contained within the rain wetting the soil. Green Lightning devices create lightning in a controlled environment under the same premise. Air and water are sent into a static electric field for the nitrogen molecule to go through a rearrangement process that allows attachment of the water present, flowing through the machine, and deposits an end product as NO<sub>2</sub> (nitrite) and NO<sub>3</sub> (nitrate).

A six head system called the THUNDER 365, produces nitrogen for 550 acres of corn annually. This system is designed for use by a farmer, in his/her own tool-shed, to make nitrogen by using only a 110v power, grounding rods, and a water supply.

This study compares the use of Green Lightning nitrogen as a seed treatment compared to a control of 80/20 Talc/Graphite. Table 1. Illustrates when using Green Lightning as a seed treatment at a rate of 1gal/ac, we increased yield by +5.1 Bu/A. With the low cost of \$0.04 cents a gallon to make this product, that yield gain resulted in +\$20.77/A.

Figure 1. Green Lightning Machine

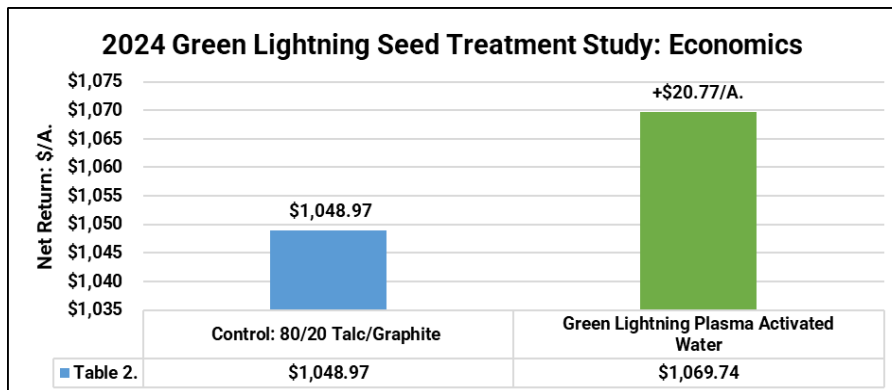
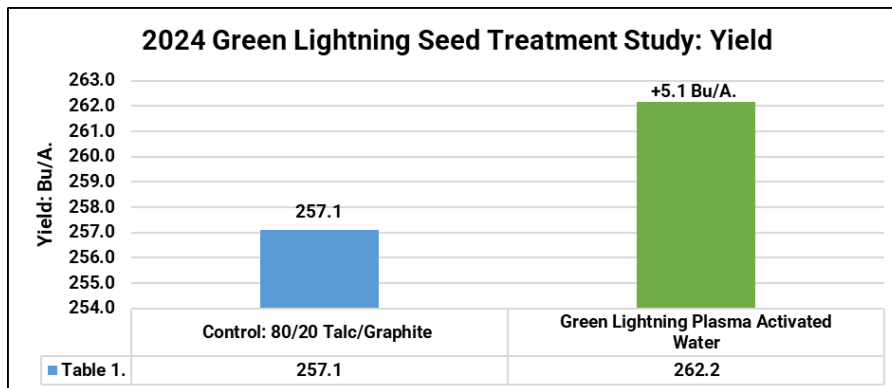

Planting Date: April 30<sup>th</sup>    Hybrid: GH 030U8    Population: 36K    Row Width: 30"    Rotation: CAB    Corn Price: \$4.08

## HyperSound Technology Seed Treatment Study

**Objective:** This trial evaluates the advantages and disadvantages of using HyperSound Technology as a seed treatment. HyperSound Technology by WISE LIFESTYLE is a process of changing the harmonic vibrations to offset the electromagnetic disturbances mobile radio and wireless communication generate.

A quantum field generator uses a femtosecond laser to irreversibly change and optimize the atomic structure (lattice) of crystalline matter such as certain metals and crystallized silicon dioxide. This charged metal begins to emit HyperSound frequencies which influences its environment and neutralizes existing electromagnetic disturbances.

**Results:** HyperSound treatments resulted in yield gains of +0.7 Bu/A and a positive net return on investment of +\$2.65/A.

Figure 1. Treating seed with 6" HyperSound Egg

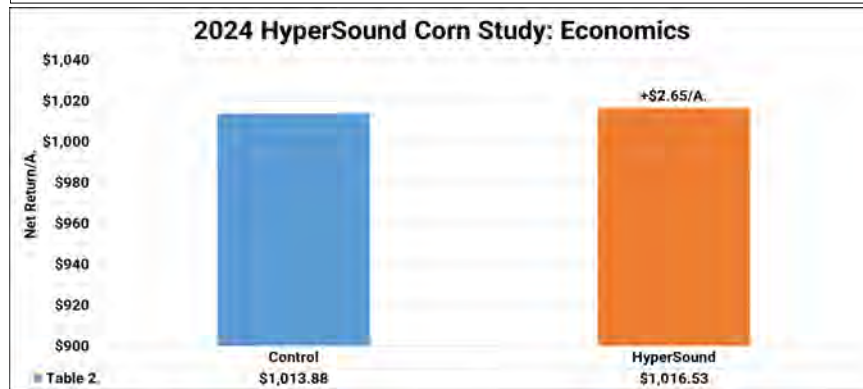
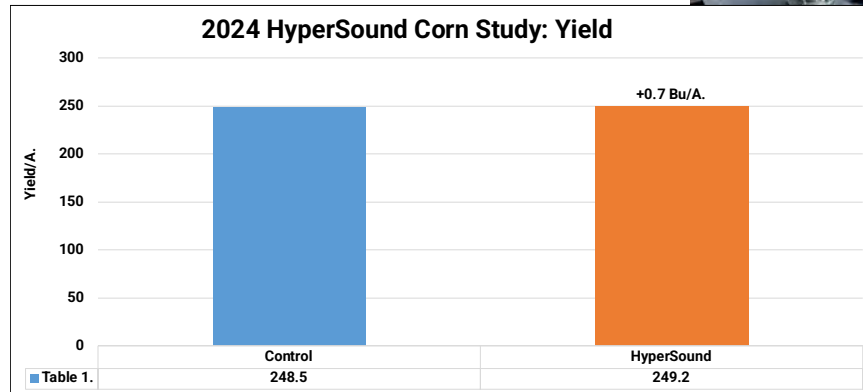

Planting Date: May 5<sup>th</sup>    Hybrid: Channel 215-09    Population: 36K    Row Width: 30"    Rotation: CAB    Corn Price: \$4.08

## Broadcast vs Banding Dry Fertilizer Study

**Objective:** To evaluate yield and economics of traditional broadcast applications of dry fertilizer compared to 8" deep high concentrated strip-till banding.

Based upon soil test results and yield goals of 240 Bu/A. corn in a corn/soybean non-irrigated rotation, a broadcast surface application was made with a traditional spinner truck (Figure 1). Using the same fertilizer rates, a strip-till bar was used to place fertilizer in high concentrated strips 8" deep on 30" corn rows (Figure 2). Corn was then planted directly into the strips above the 8" fertilizer placement. A KUHN® Krause® 1200 Gladiator® pulling a Montag® Equipment 2208 Gen 2 fertilizer cart was used to implement this testing program for 2024.

**Results** Table 1. illustrates banded fertilizer outperformed broadcast at every efficiency rate. 100% rates offered +2.1 yield increases, 75% the highest advantage of +3.0 Bu/A., 50% at +2.6 Bu/A. and 25% banded rates at +4.4 Bu/A.

Figure 1. Traditional Spinner Truck



Figure 2. Strip-Till Banded Fertilizer

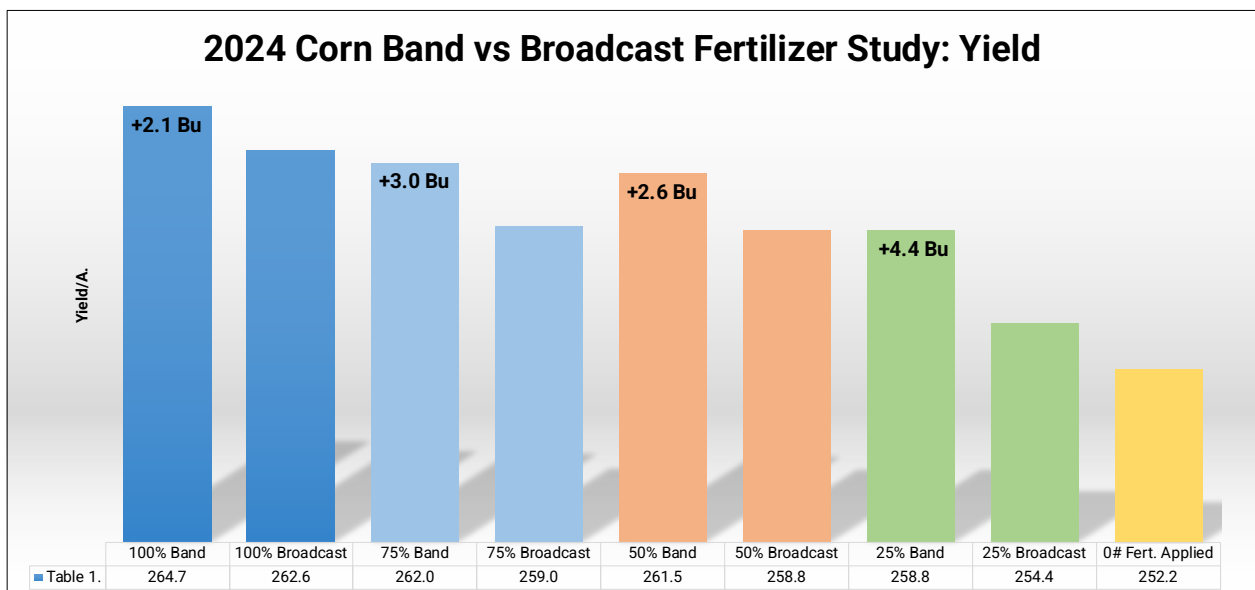

## Broadcast vs Banding Dry Fertilizer Study Continued

Using University of Illinois Machinery Cost Estimates in Table 2., strip-till resulted in additional costs of +\$9.60/A. in comparison to a conventional tillage program. Using this cost scenario, Table 3. illustrates the economic impact. 100% banded rates of fertilizer offer minimal yield gains, thus resulting in economic losses of **-\$1.03/A.** The trend continued with 75% and 50% banded rates offering small gains +\$2.64/A., 50% at +\$1.41/A. However, 25% bands offered highest advantage at +\$8.35/A.

Table 2. University of IL Machinery Cost Estimates

Tillage Practice	Category	Cost
Conventional Till	Soil Finisher	\$ 14.60
	Plant	\$ 21.40
	Fertilizer Spread	\$ 8.00
	Total:	\$ 44.00
Strip Till	Strip	\$ 25.90
	Burndown	\$ 6.30
	Plant	\$ 21.40
	Total:	\$ 53.60

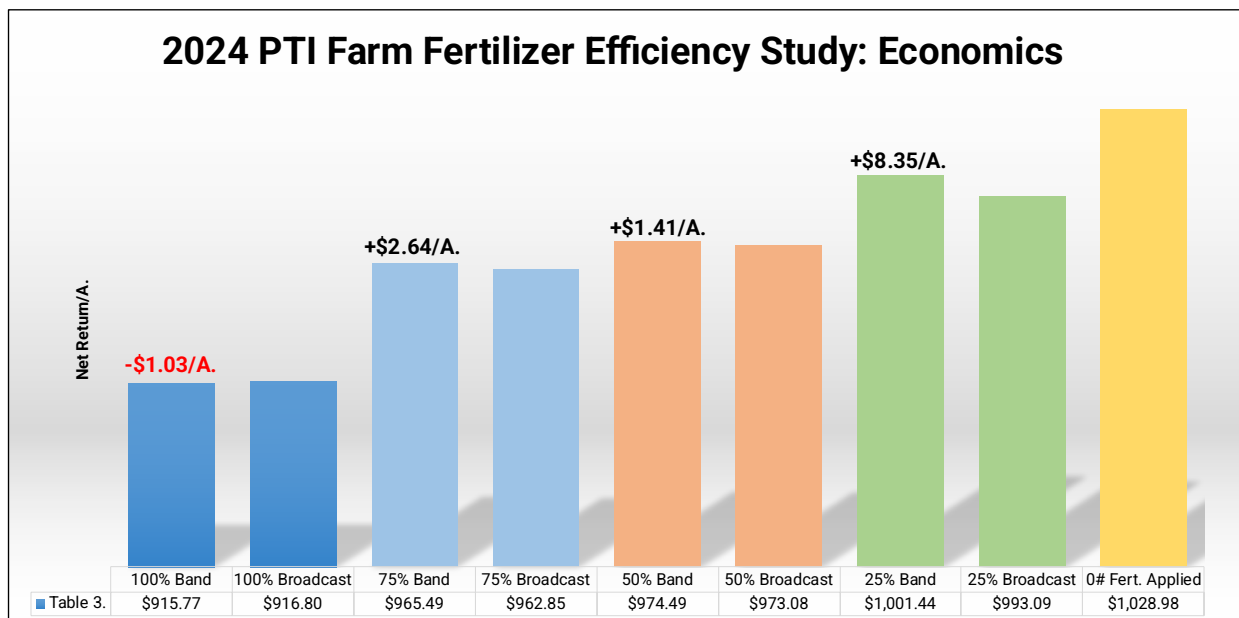



## Broadcast vs Banding Dry Fertilizer Study Continued

Table 4. illustrates multi-year data from the PTI Farm over the years 2021, 2022, 2023, and 2024. Over this timeframe, banded dry fertilizer has resulted in the highest average yield gains at the 75% and 50% at +5.7 to +7.4 Bu/A. respectively. 100% rates offered gains of +5.4 Bu/A., while lower 25% rates at +3.5 Bu/A.

Table 5. reflects the economics over the same 4-year time period. 75% and 50% banded rates of fertilizer offered +\$20.42 to +\$28.77/A. over same broadcasted rates. 100% rates proved an +\$18.64/A. gain, while 25% banded rates incurred gains of only +\$6.98/A.

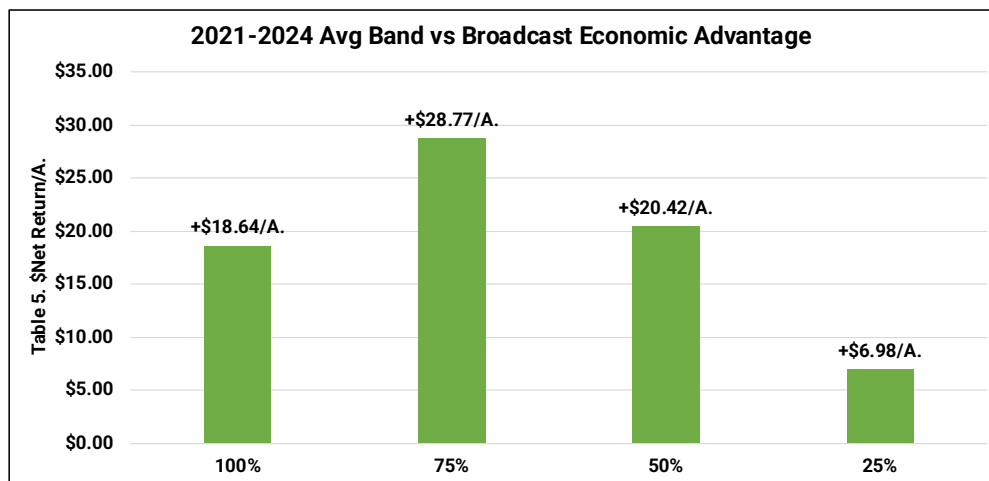
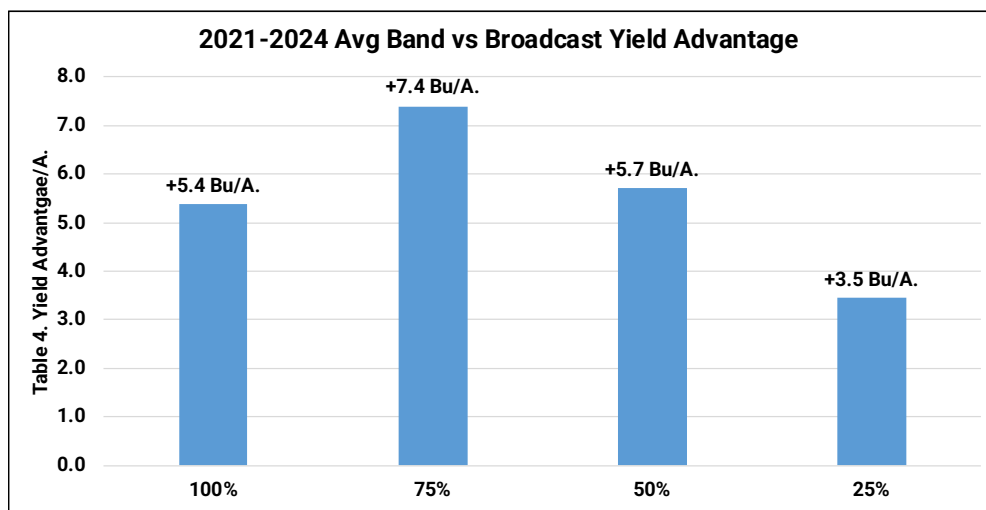

Planting Date: April 30<sup>th</sup>    Hybrid: DKC 66-17RIB    Population: 36.5K    Row Width: 30"    Rotation: CAB    Corn Price: \$4.08

## Broadcast vs Banding Rate Efficiency Study

**Objective:** This study evaluates yield and economics of traditional broadcast applications of dry fertilizer compared to concentrated strip-till bands applied 8” in depth under the corn row. The goal of this study is to answer the question; “If I band dry fertilizer versus broadcast applying, can I use a lower rate of fertilizer without sacrificing yield and profitability”?

Based upon soil test results (Fall 2023) and yield goals of 240 Bu/A. corn in a corn/soybean rotation, dry fertilizer was applied in a traditional broadcast surface application as a spinner truck (Figure 1).

To study placement efficiency, using the same fertilizer rates, a strip-till bar was used to place fertilizer in high concentrated strips 8” deep on 30” corn rows (Figure 2). Corn was then planted directly into the strips above the 8” fertilizer placement.

A KUHN® Krause® 1200 Gladiator® pulling a Montag® Equipment 2208 Gen 2 fertilizer cart was used to implement this testing program for 2023.

To address, rate efficiency, fertilizer was applied at the following rate structure in both strip-till bands and broadcast applications:

- 100% Rate
- 75% Rate
- 50% Rate
- 25% Rate
- 0% Rate

Figure 1. Broadcast Dry Fertilizer



Figure 2. Strip-Till Banded Fertilizer 8” in Depth



Figure 3. Gladiator® Strip-Till Unit with Montag® Fertilizer Cart



## Broadcast vs Banding Rate Efficiency Study Continued

**Results:** Table 1. illustrates the yield of all rates in band and broadcast applications. Highest overall yield came from 100% banded application at 264.7 Bu/A., however was only +2.1 Bu/A. better than 100% rates in a traditional broadcast application. As rates were lowered to 75% and 50% rates, yields only fell by **-0.6** to **-1.2 Bu/A.** 25% bands resulted in minimal losses of **-3.8 Bu/A.** Applying no fertilizer at all resulted in highest losses of **-10.4 Bu/A.**

Table 2. describes a telling story summarizing economics. Even though 100% rate bands achieved higher yield, the cost of banding vs spinner spreading offset the advantage, thus losing **-\$1.03/A.** 75%,50% and 25% rates in bands all resulted in gains of +\$48.69, +\$57.69/A. and +\$84.64/A., due to very little yield loss combined with 25%-75% less fertilizer cost.

0# rates fertilizer proved optimum economical rate with a net return of +\$112.18/A., compared to 100% broadcast applications.

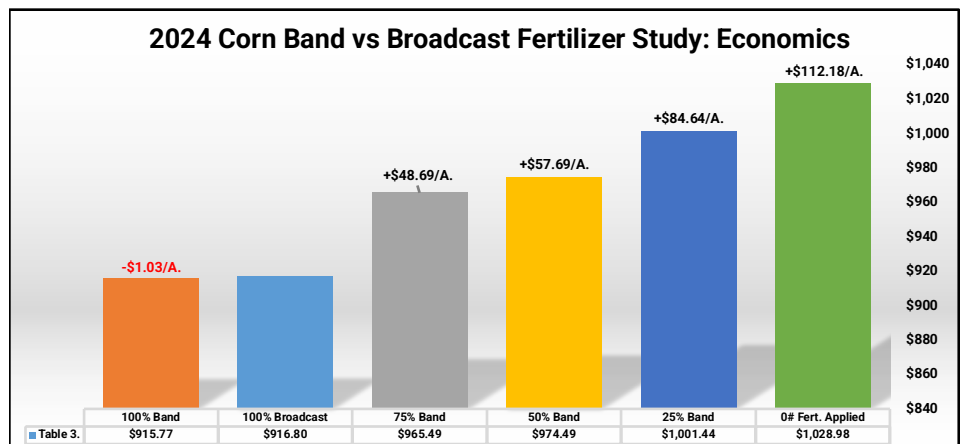
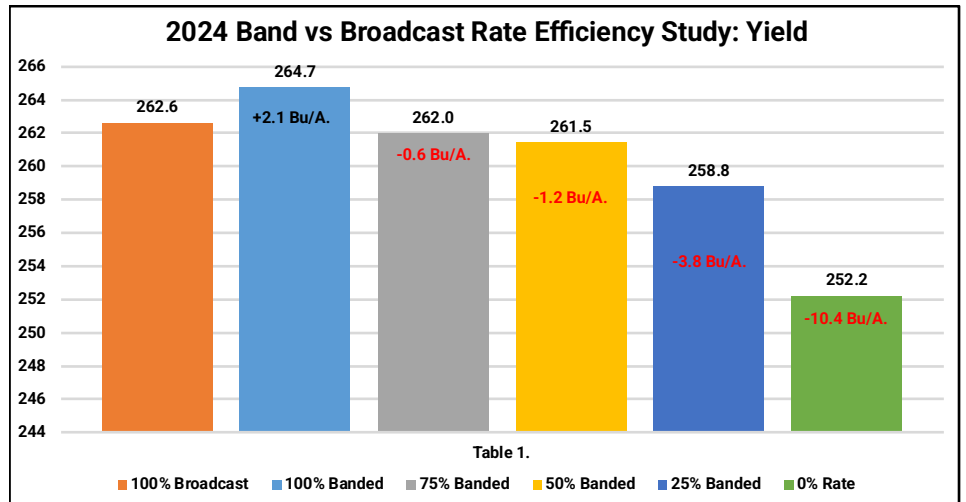

## Broadcast vs Banding Rate Efficiency Study Continued

This study is designed as a 10-yr study to look at a long term approach of evaluating fertilizer performance, cost of fertilizer, and overall soil test levels. 2024 was our 4th year of this long term study and since soil samples are taken annually, it gives us the ability to monitor soil test levels at each fertilizer rate over time. The tables below summarize soil test P and K levels from our first soil test in year 1, compared to new soil test in 4<sup>th</sup> year (2024) in the 100% full fertilizer rates as well as the 0% no fertilizer applications.

After four years, the tables below show differences of 100% and 0% rates of fertilizer for soil test P and K levels. 0% rates have resulted in lower soil test levels, however both P&K levels are currently sufficient. As a 10-yr program, it will be interesting to monitor these levels over time.

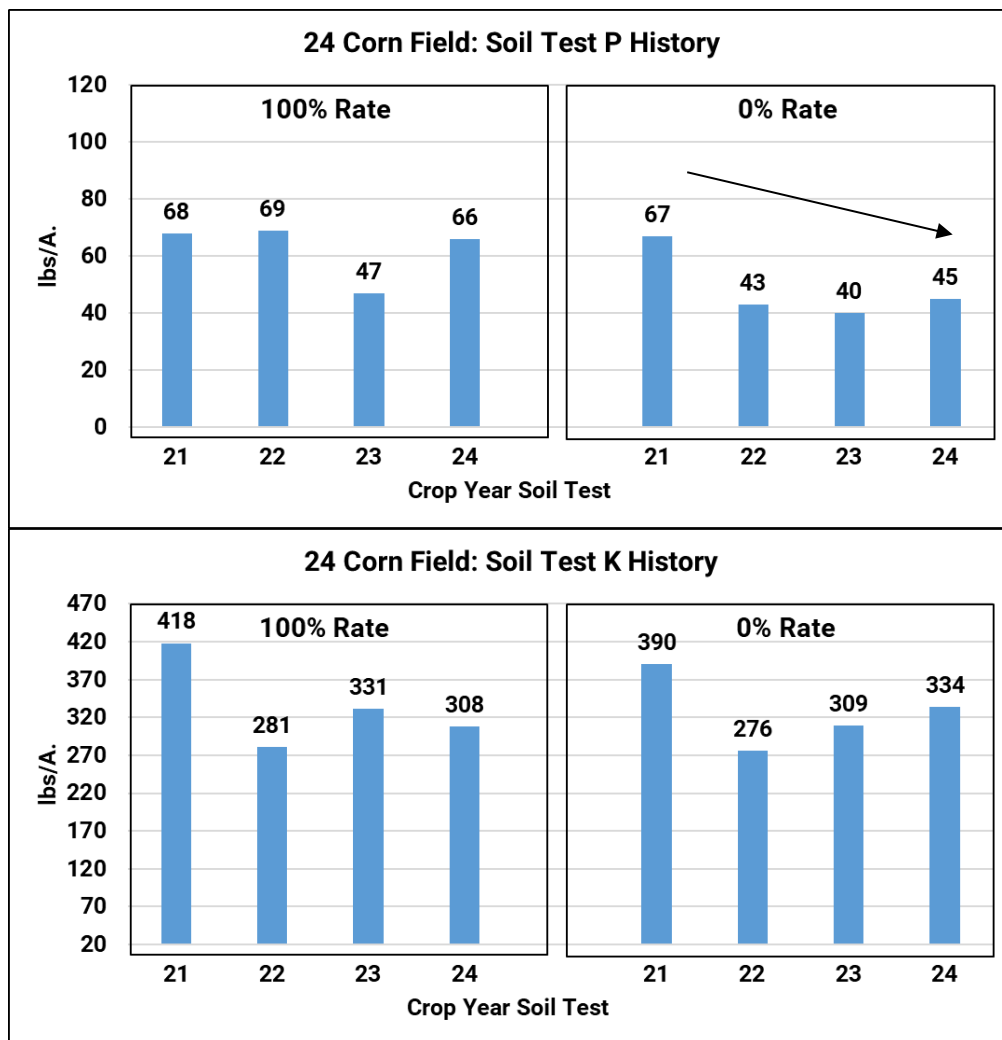

## Mosaic® Sulfur/Boron Dry Fertilizer Study

**Objective:** To evaluate yield and net return of Mosaic® fertilizer products MicroEssentials® SZ™ and Aspire® to offer sulfur and boron in addition to traditional dry phosphorous and potassium fertilizer.

MicroEssentials® SZ™ is a 12-40-0-10S-1Zn and combines nitrogen, phosphorus, sulfur, and zinc into one nutritionally balanced granule, creating a single source for balanced crop nutrition. The unique chemistry and precise nutrient ratio of MicroEssentials® features; uniform nutrient distribution, increased nutrient uptake, and season long sulfur availability.

Formulated using Nutriform® technology, Aspire® is a 0-0-58 that provides two forms of boron (Sodium Borate 50% and Calcium Borate 50%) with potassium into a single granule for uniform nutrient distribution, season-long boron availability and flexible spring or fall application.

In this study, both Mosaic products are equivalently compared to traditional applications of 230#/A. of 18-46-0 DAP and 130#/A. of 0-0-60 potash as a control.



MicroEssentials <sup>®</sup> SZ <sup>™</sup>				
12	40	0	10	1
N	P <sub>2</sub> O <sub>5</sub>	K <sub>2</sub> O	S	Zn

Aspire <sup>®</sup>			
0	0	58	0.5
N	P <sub>2</sub> O <sub>5</sub>	K <sub>2</sub> O	B

## Mosaic® Sulfur/Boron Dry Fertilizer Study

Boron (B) is a micronutrient critical to the growth and health of all crops. It is a component of plant cell walls and reproductive structures. Boron, a water-soluble micronutrient, is especially prone to leaching. Since boron is a neutrally charged ion, it floats in ecosystems until it finds a substance to which it can bond to. During periods of heavy rain, boron is flushed out of the soil quickly. Boron serves two primary roles; one is supporting plant cell division, and the second is during the silking stage of development, in which boron helps transfer water and nutrients from the roots up through the plant. B is required in small amounts, in fact a 200 Bu/A. crop only uptakes 0.2lbs of B.

Sulfur (S) is an essential nutrient for corn growth and is a critical nutrient to make required proteins. One bushel of corn typically requires 0.1 to 0.12lbs/Bu. S uptake occurs over the entire growing season, with relatively constant uptake from the 14-leaf stage to maturity. Unlike nitrogen, only 40% to 50% of S is taken up by flowering. S is also very mobile in most soils, like nitrate, because it has a double negative charge and is repelled by the negative charge of the soil, unlike nutrients like potassium, calcium, or magnesium

**Results:** Mosaic® Micro-Essentials® SZ® offered yield advantages of +4.8 Bu/A. over a traditional DAP program. These yield advantages equated to positive net returns of +\$6.74/A. after cost of product. ASPIRE® treatments replacing traditional potash offered yield advantages of +1.5 Bu/A., however equated to a negative return of **-\$5.51/A.**

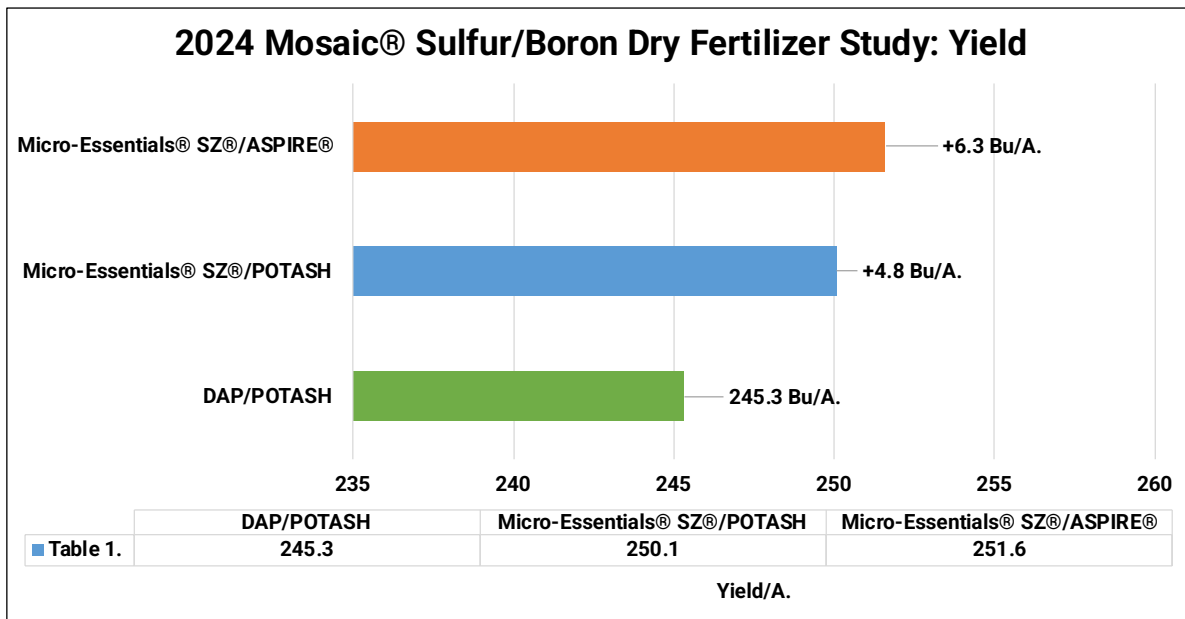

Planting Date: May 9<sup>th</sup>    Hybrid: DKC 56-26    Population: 36K    Row Width: 30"    Rotation: CAB    Corn Price: \$4.08    Mosaic SZ/ASPIRE: \$116.60/A.  
Mosaic SZ/POTASH: \$104.97/A.    DAP/POTASH: \$92.13/A.

## Liquid vs Dry Fertilizer Fall Strip-Till Study

**Objective:** To evaluate yield and economic impact of dry and liquid fertilizer programs in fall strip-till bands. This 2<sup>nd</sup> year study compares a traditional dry 18-46-0 and 0-0-60 fertilizer program versus a replacement liquid fertilizer program. Treatments were as follows:

<p><b><u>#1: 100% Dry Fertilizer Program:</u></b></p> <p>150# 18-46-0 + 150# 0-0-60</p>
<p><b><u>#2: 50% Dry Fertilizer Program:</u></b></p> <p>75# 18-46-0 + 75# 0-0-60</p>
<p><b><u>#3: 25% Dry Fertilizer Applied</u></b></p> <p>37.5# 18-46-0 + 37.5# 0-0-60</p>
<p><b><u>#4: Control: No Fertilizer Applied</u></b></p>
<p><b><u>#5: Liquid Fertilizer Program: 25% Nutrient Equivalent to Dry Program</u></b></p> <p>6.25 Gal/A. Nachurs® Throwback® 8-27-4-2S          10 Gal/A. Nachurs® K-flex® 0-0-19-6S</p>
<p><b><u>#6: Liquid Fertilizer Program: 50% Nutrient Equivalent to Dry Program</u></b></p> <p>12.5 Gal/A. Nachurs® Throwback® 8-27-4-2S          20 Gal/A. Nachurs® K-flex® 0-0-19-6S</p> 
<p><b><u>#7: Liquid Fertilizer Program: 100% Nutrient Equivalent to Dry Program</u></b></p> <p>25 Gal/A. Nachurs® Throwback® 8-27-4-2S          40 Gal/A. Nachurs® K-flex® 0-0-19-6S</p>

## Liquid vs Dry Fertilizer Fall Strip-Till Study

All liquid treatments were applied in the Fall made with Black Eagle Ag Solution's strip-till unit.



This bar was fitted with Pump Stack® (Figure 1.), a liquid fertilizer hydraulic pump. It was paired with EMHD® and EM FlowSense™ (Figure 2.) to ensure a top-notch fertilizer application, as well as row control across the bar. EMHD® controls liquid application rates using an electromagnetic flow meter. This opens your options for a wider range of liquid products. EM FlowSense™ allows you to measure the rate of fertilizer you are applying on each row of the bar, to make you aware of any row-to-row variability that is occurring. With a Pump Stack® system, paired with EMHD®, and EM FlowSense™ you can be confident in your application rate across every row.



Figure 1. Pump Stack®



Figure 2. EMHD® + EM FlowSense™



## Liquid vs Dry Fertilizer Fall Strip-Till Study

**Results:** Table 1. illustrates all rates of dry and liquid fertilizer applications offered positive yield response. Dry rates offered yield gains of +25.3 Bu/A. to +47.7 Bu/A. Liquid rates posted yield gains of +21.4 Bu/A. to +59.4 Bu/A. over the no fertilizer control.

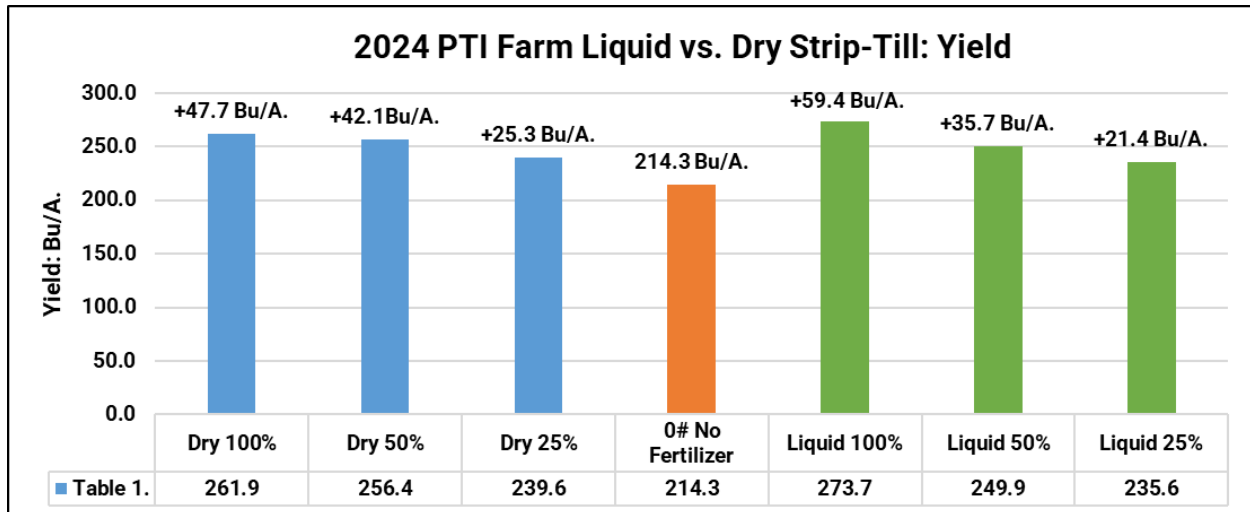
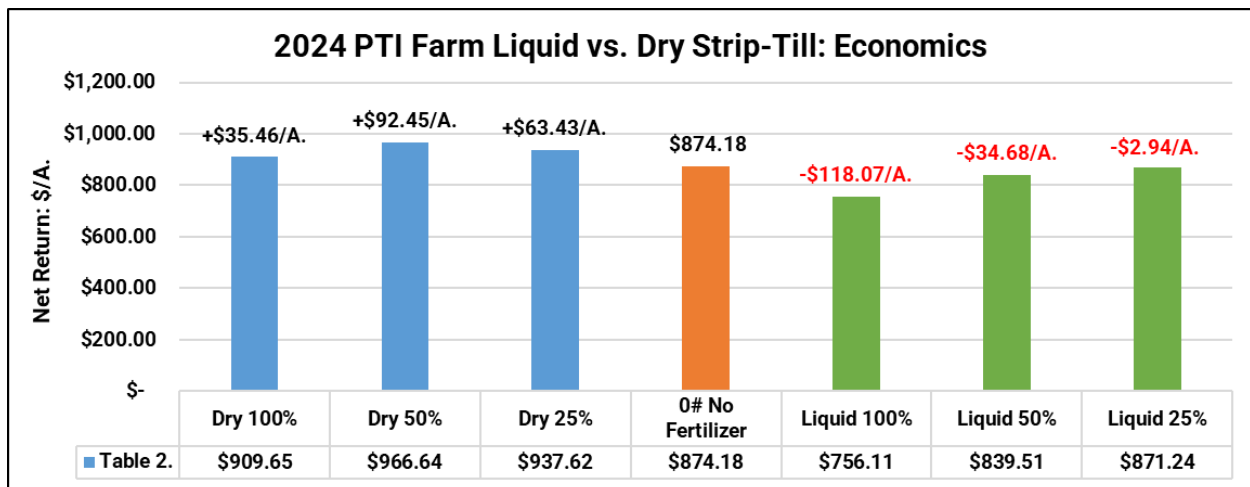

Table 2. reveals the overall economics of the treatments. All dry fertilizer treatments posted net economic gains ranging from +\$35.46/A. to +\$92.45/A. While all liquid rates proved economic losses due to the cost of product, ranging from -\$2.94/A. to -\$118.07/A. Overall, the Black Eagle strip-till unit performed well in regard to tillage.



Planting Date: May 26<sup>th</sup>    Hybrid: Wyffels 7945    Population: 36K    Row Width: 30"    Rotation: CAB    Corn Price: \$4.08  
 Liquid Program: 100% \$360.50/, 50% \$180.25, 25% \$90.13    Dry Program: 100% \$159.00, 50% \$79.50/A., 25% \$39.75/A.    Avg Soil Test Level: P:65#/A. K: 393#/A.

## Calcium Products™ 98G™ Pell Lime Corn Study:

**Objective:** This trial evaluates the yield response and economics of pelletized limestone (98G™) applied fall broadcast.

Soil pH is the foundation of nutrient availability and critical to maximizing crop yield. The availability of all nutrients is impacted by soil pH levels, especially phosphorus (P).

When soil pH is below 6.0, it can reduce your yield by as much as 30%. Calcium Products' 98G™ pelletized limestone is the most effective and consistent product to correct and maintain soil pH.

Soil pH has traditionally been addressed about every four years with aglime. Rather than create a pH "rollercoaster" in the field with infrequent aglime applications, 98G® can be used as part of a pH maintenance program with annual or biannual applications. 98G® is a more reactive liming material than aglime, keeping soil pH at a level to maximize yield potential (typically 6.0) year after year.

**Results:** Broadcast treatments of 98G™ Pell Lime were applied in broadcast rates of 100#-500#/A. in Fall of 2023. All rates proved yield advantages of +9.8 Bu/A to +17.9 Bu/A. 200#/A. rate proved economic optimum at +\$36.68/A. net returns.



<p><b>Maintain Soil pH</b> 98G can be applied in flat-rate or variable-rate applications. It can be mixed with other dry fertilizers reducing the number of trips across the field and spread spring or fall. This flexibility means you can address soil pH when and how it works for you with the same equipment used to spread other dry fertilizers. Once soil pH is restored, use 98G to maintain pH levels with more frequent,</p>	<p><b>Change Soil pH Quickly</b> 98G corrects soil pH faster and more completely than aglime. It is the most reactive liming material because it's made from 98% pure calcitic limestone and ground to an ultra-fine powder before it is pelletized. 98G pellets are engineered and manufactured to a specific size and hardness so that the pellets handle well and spread uniformly yet break down in the field to change soil pH. 98G is fully reactive at about three to six months after application.</p>	<p><b>Enjoy Application</b> 98G can be applied in flat-rate or variable-rate applications. It can be mixed with other dry fertilizers reducing the number of trips across the field and spread spring or fall. This flexibility means you can address soil pH when and how it works for you with the same equipment used to spread other dry fertilizers.</p>
--	--	---

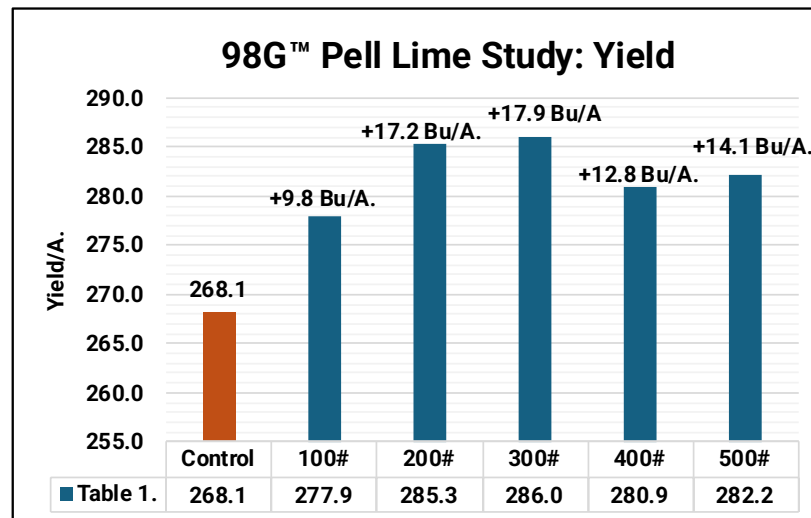

Planting Date: May 15<sup>th</sup> Hybrid: GH 14B32 Population: 36K Row Width: 30" Rotation: CAB Corn Price: \$4.08 Pell Lime: \$275/Ton + \$6/A Application

## Smart Hydrogel Soil Moisture Retainer Study

**Objective:** To evaluate yield and economics of Hydrogel by Green Evolution Technologies. Hydrogel is a retainer product that is incorporated into the soil to retain large amounts of water and nutrients. The absorbed water and nutrients are released during dry soil conditions, allowing the plant access when needed. Hydrogel is being implemented at the PTI Farm to help improve irrigation efficiency, increase water holding capacity and potentially to protect against erosion and soil crusting conditions.

Hydrogel was applied directly into the soil, using the Precision Planting DrySet™ system. DrySet is an at-plant system that allows for accurate banded applications. In this case, Hydrogel was banded to surround the seed trench and lightly incorporated by the planter closing system to allow Hydrogel to surround the furrow and eventual rooting area.

DrySet™ is an all-in-one meter and electric drive system that provides row-by-row, electric motor rate control. DrySet™ was engineered for consistent distribution of granular products on planters with granular tanks and features two different auger options to cover a variety of rate ranges and applications. DrySet works in conjunction with the Precision Planting 20|20® system, with row-by-row control each meter functions independently of others, offering benefits like turn compensation, variable rate, and swath control. Currently, DrySet™ is designed for planters in the southern hemisphere.

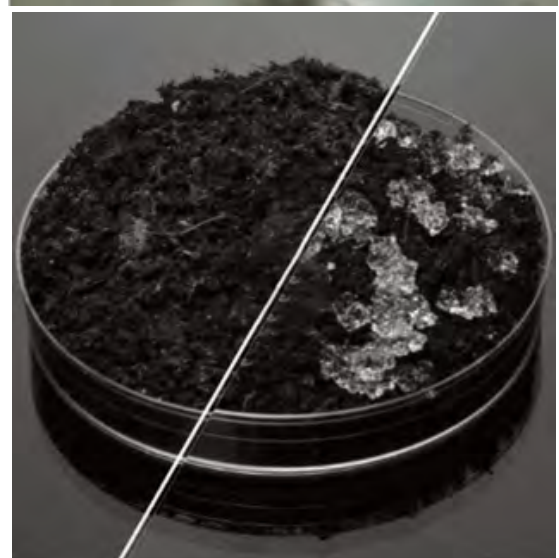

## Smart Hydrogel Soil Retainer Study

**Results:** At-plant applied treatments of 25#/A. Hydrogel resulted in yield gains of +19.2 Bu/A., with corresponding economic net returns of +\$59.09/A. These results equate to a +9.8% increase in yield and a +7.4% economic increase.

Late season drought conditions at the PTI Farm was most likely an ideal environment to evaluate the potential of the Hydrogel system. We look forward to continuing studying this product in the future.

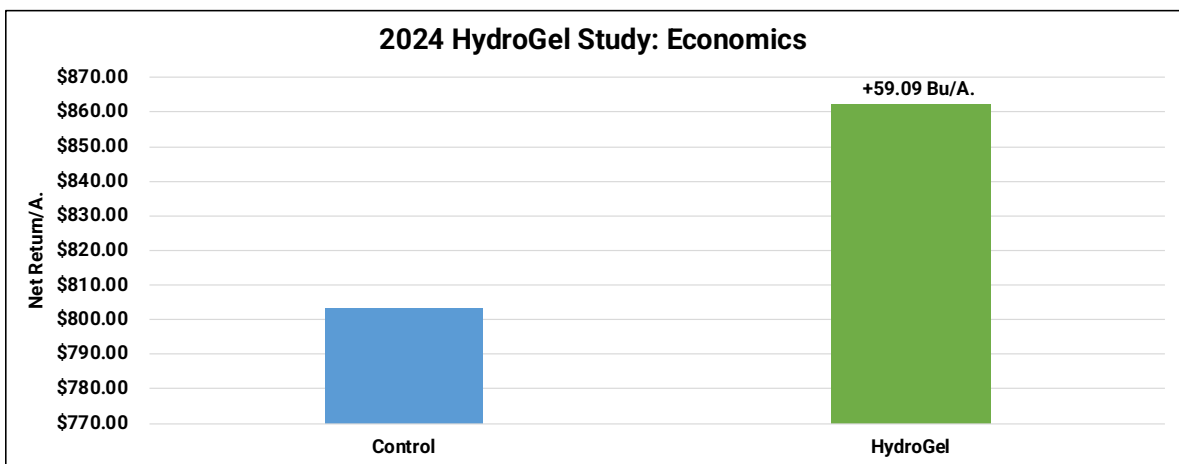
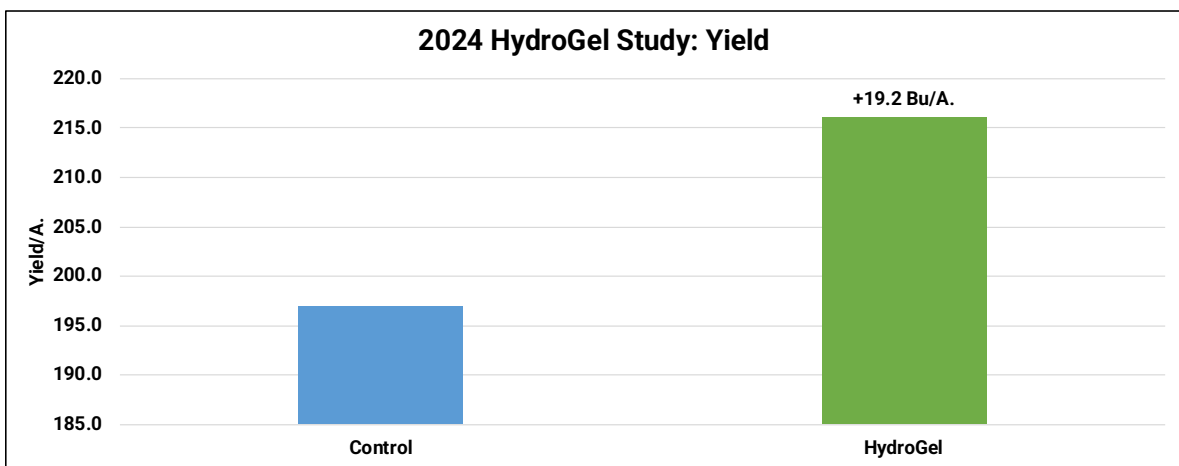

Planting Date: May 15<sup>th</sup>   Hybrids: GH 03R40   Population: 36K   Row Width: 30"   Rotation: CAB   HydroGel: \$19.25/A.   USDA Code 450 Rebate: \$3.23/#   Corn Price: \$4.08

## High Management Corn NETAFIM™ Irrigation Study

**Objective:** This study evaluates NETAFIM™ drip tape irrigation designed and installed by NutraDrip Irrigation Systems, and its' ability to feed corn with water and nutrients for high yield potential. This method of irrigating a crop uses NETAFIM® drip tape with small pressure regulated emitters evenly spaced at 24" apart. Water is accessed from a water recycling management program installed at the PTI Farm.

**Results:** In 2024, NETAFIM™ drip tape irrigation resulted in increased average corn yields of +64.9 Bu/A., over the non-irrigated control. 9.25" of rain was applied through drip irrigation throughout the growing season from June - September. 2024 marks the third highest annual yield response over the 6-yr's of drip irrigation at the PTI Farm.

Multi-Year data over 2019-2024 has proven to increase corn yield by an average of +58.8 Bu/A., while increasing additional gross income by an average of +\$264.79/A.

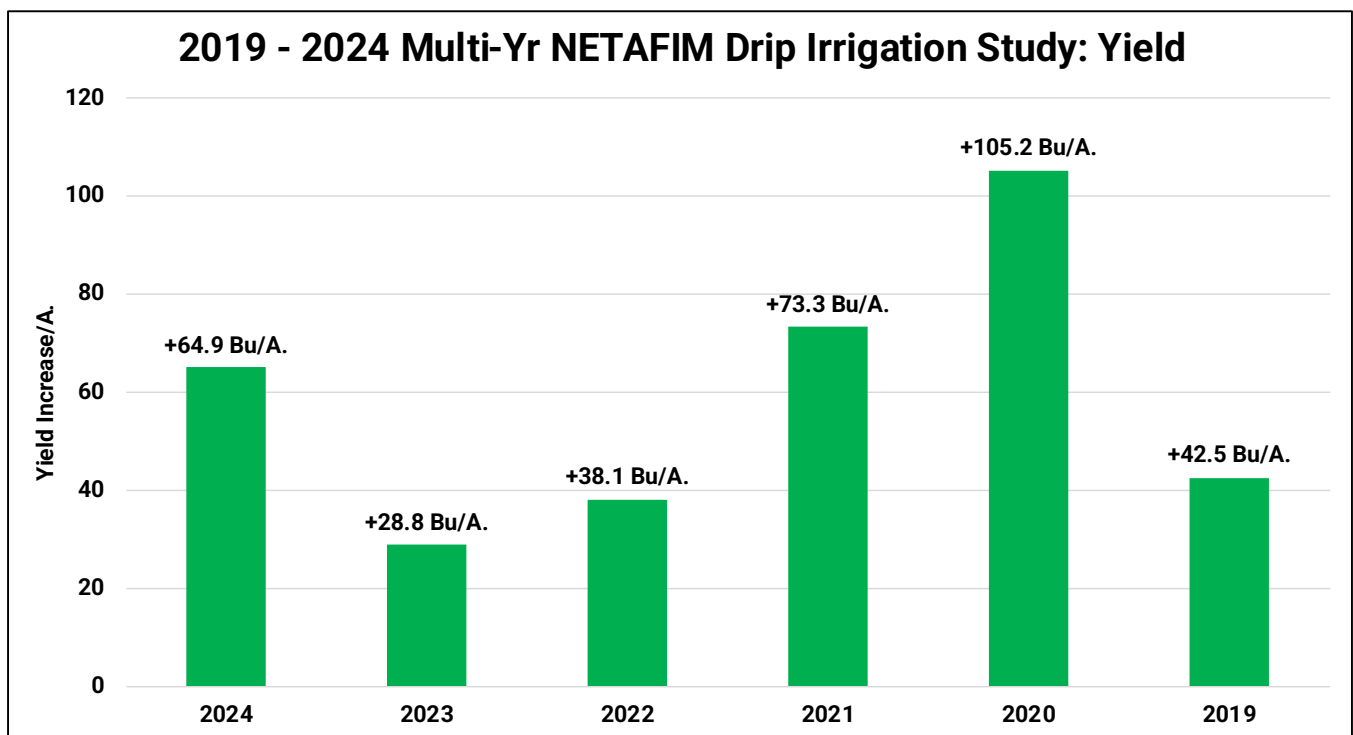

## NETAFIM™ Sub-Surface vs Surface-Irrigation Study

**Objective:** This study evaluates NETAFIM™ drip tape irrigation and its ability to feed corn with water and nutrients for high yield potential in a surface and sub-surface installation.

This method of irrigating a crop uses NETAFIM™ drip tape with small pressure regulated emitters evenly spaced at 24" apart. Water is resource from a water recycling management program installed at the PTI Farm.

Surface irrigation is placed on top of the soil surface on 60" spacing down the middle of the 30" row (Figure 1).

Sub-surface irrigation is buried 14" in depth on 40" centers (Figure 2). Sub-surface irrigation was installed in the fall of 2021.



Figure 1. NETAFIM™ Surface Irrigation



## NETAFIM™ Sub-Surface vs Surface-Irrigation Study

**Results:** NETAFIM™ sub-surface drip tape irrigation resulted in increased average corn yields of +6.9 Bu/A., over surface applied drip tape. Sub-surface irrigation tape was installed in the fall of 2021 and just like drainage tile, we had a suspicion that it may take some time for sub-surface drip irrigation to settle into place correctly, repair soil density of installation, and get proper water permeability throughout the soil profile quickly. These positive yield gains of +6.9 Bu/A. are encouraging to see the second year of this study and we think these numbers could go much higher in future years as the aspects mentioned above improve on an annual basis. It is interesting to note that 2023 proved similar yield advantage of +6.6 Bu/A.

Surface drip irrigation has its advantages and disadvantages. It can be an effective, faster way to get water to a crop, however it can suffer moisture losses being exposed to sunlight, temperature, and wind on the soil surface. Keeping the soil surface moist can also lead to a higher threat of disease. Labor is also a concern, as the tape needs to be manually laid and picked up annually.

9.25" of rain was applied through drip irrigation throughout the growing season from June - September. Fertigation was also implemented through both systems to apply N, B, Cu, S, P, and K as needed.

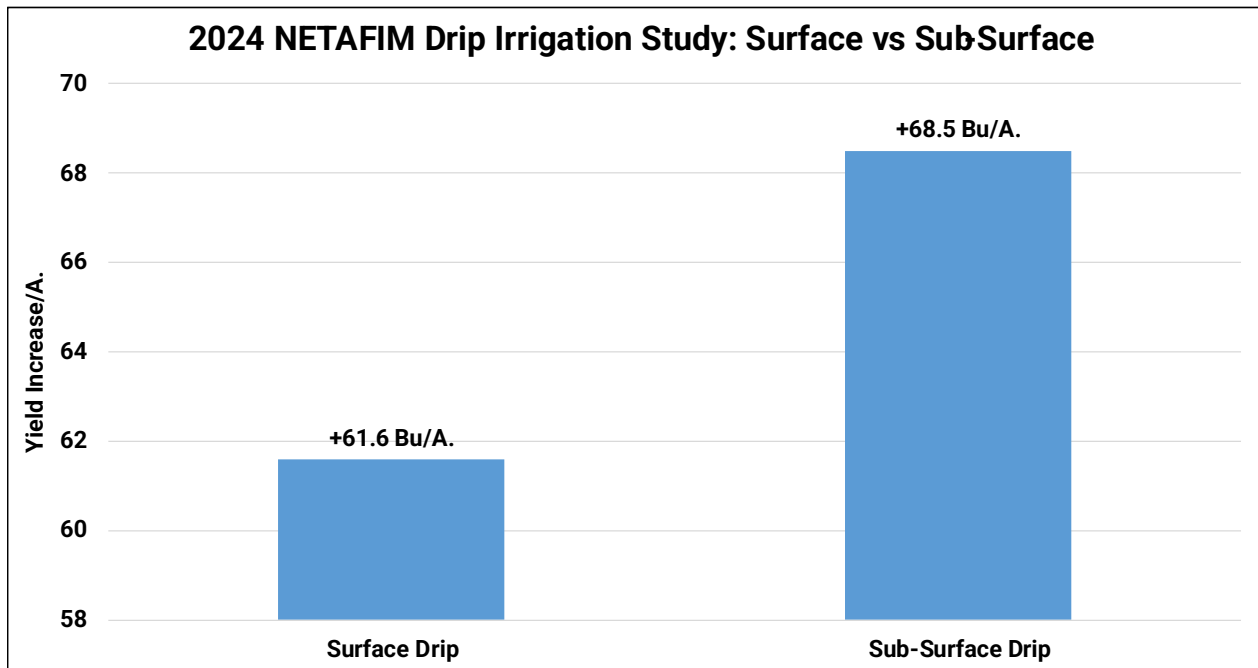

## Tile Drainage and Sub-Irrigation Study

**Objective:** This study will evaluate the agronomic and economic benefits of using 15' and 30' 3" plastic field tile to not only drain saturated soils (Figure 1.), but to also back-feed irrigation water through the field tile to offer irrigation to a growing crop.

Figure 2. shows the layout of our pattern tiled field installed in the early spring of 2021. Both 15' and 30' pattern tile widths were used to understand the difference in the soil's capillary action or uptake of water. This study is one of many at the PTI Farm designed as long-term 10+ year studies to study consistency and longevity of the system.

Figure 1. Tile Installation



Figure 2. 15' and 30' Pattern Tile Installation





## Tile Drainage and Sub-Irrigation Study

**Results:** The first objective of this study was to evaluate the differences between tile spacing. In 2024, 15' pattern tile offered yield advantages of +13.9 Bu/A, which equates to additional gross farm revenue of +\$62.02/A.

30' pattern tile offered yield advantages of +15.3 Bu/A. and gross revenue of +\$39.17/A. These numbers would indicate that it fell behind 30' pattern tile by only **-1.4 Bu/A.** with corresponding gross revenue loss of only **-\$5.71/A.** This is the first year 15' tile has proven lower yield than the 30' tile patterns. We believe this discrepancy is due to the rainfall deficit throughout the growing season. In fact, over 9" of irrigation water was needed throughout the summer months to offset the lack of rainfall. However, even though droughty conditions were present in 2024, tile still offered yield gains of +13 to 15 Bu/A. Some of this increase could be attributed to 125% of normal rainfall in the month of April.

Based on data from 2022-2024, Table 1. illustrates that both 15' tile systems would pay for themselves after 14.2 crop seasons (\$1160/A. 15' Tile) and 30' tile in 12 years (\$850/A. 30' Tile)

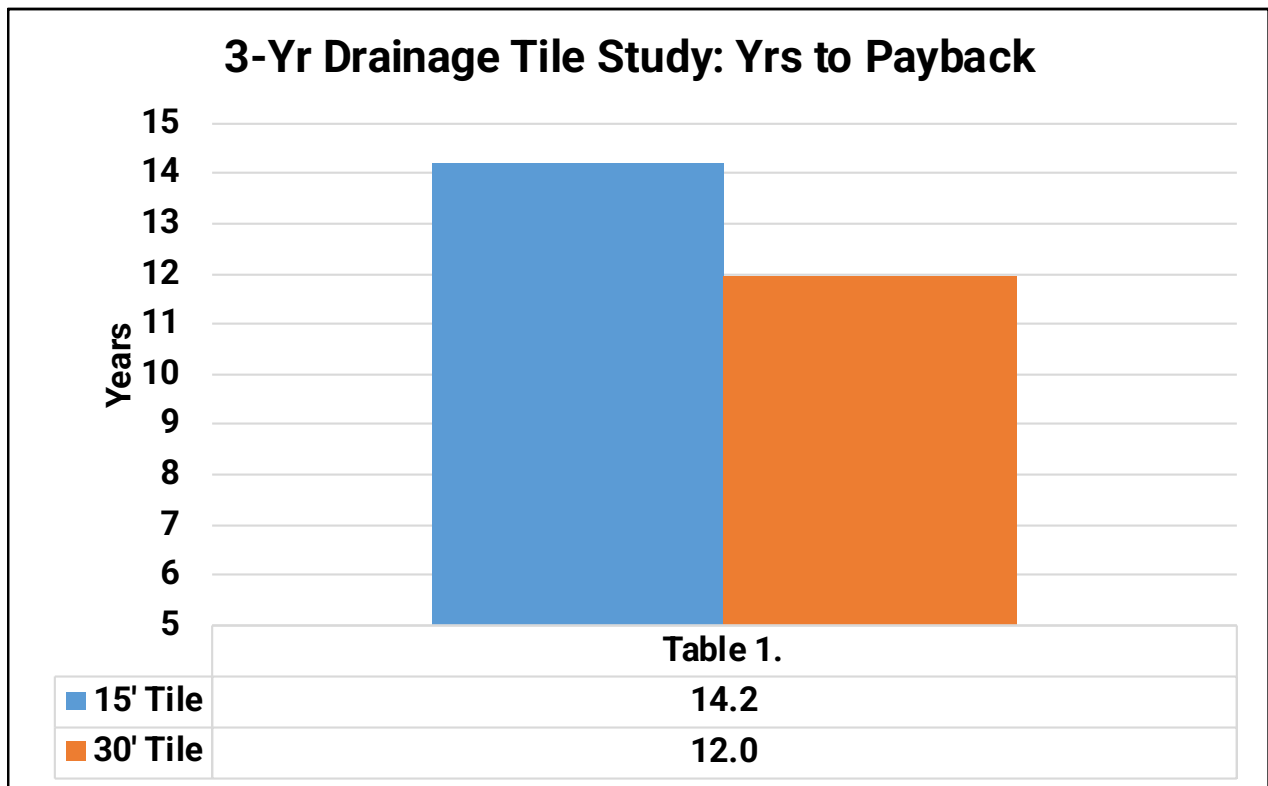

## Tile Drainage and Sub-Irrigation Study

Secondly, the other objective of this study, is using the drainage tile as option to sub-irrigate. Figure 3. is a photo of a gate system that gives the ability to control the water table. Gates can be added or removed to allow water to “back-feed” or “fill up” the tile, which in turn draws water up into the soil profile. Water is sourced and pumped out of the PTI Farm’s water recycling reservoir to back-feed the water through the tile system in the field.

Table 2. illustrates back-feeding of water proved minimal returns of +\$9.38/A. in 15’ tile pattern tile and only +\$3.67 Bu/A. in 30’ tile patterns. However, multi-year data has proven 15’ tile averaging +\$41.60/A. and 30’ at +\$26.70/A.

Figure 3. Gate Structures to Control Water Table



Though seemingly small yield gains, what was an 14.2 and 12-yr payback period mentioned above from just drainage gains, multi-year back-feeding gains would contribute additional funds and thus lower payback to 9.4 crop seasons in 15’ tile and 8.7 years in 30’ tile patterns.

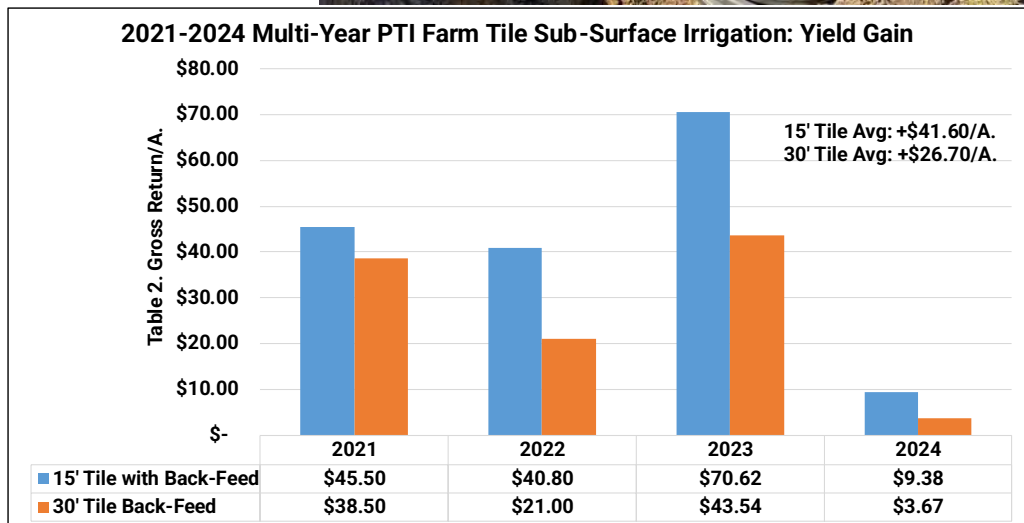

It should be

noted that the minimal yield and economic returns in 2024 was a result of the lack of rainfall in 2024. Due to very dry conditions, irrigation water in the field tile needed to be re-directed to more drip-tape, due to keep more water near the corn root mass. Sub-surface irrigation was too deep at 36”, thus finding it very difficult for corn to get water at those depths. In a normal rainfall growing season, back-feeding tends to work much easier.

## HyperSound Technology Irrigation Study

**Objective:** This trial evaluates the benefits and disadvantages of treating irrigation water with HyperSound Technology. HyperSound Technology by WISE LIFESTYLE is a process of changing the harmonic vibrations to offset the electromagnetic disturbances mobile radio and wireless communication generate.

A quantum field generator uses a femtosecond laser to irreversibly change and optimize the atomic structure (lattice) of crystalline matter such as certain metals and crystallized silicon dioxide. This charged metal begins to emit HyperSound frequencies which influences its environment and neutralizes existing electromagnetic disturbances.

**Results:** HyperSound treatments resulted in yield gains of +8.2 Bu/A with a positive net return on investment of +\$33.46/A.

Figure 1. HyperSound Egg

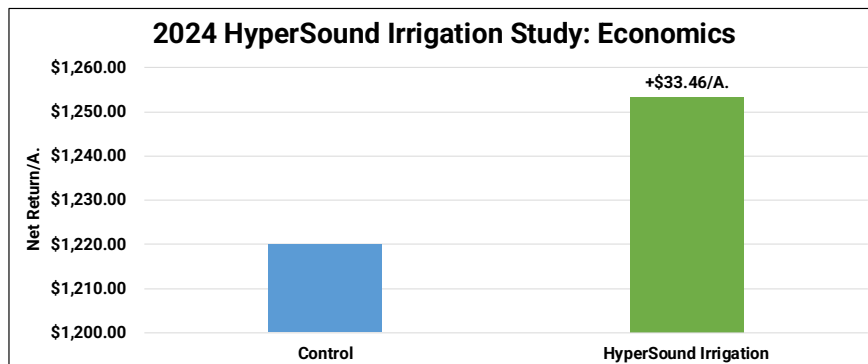
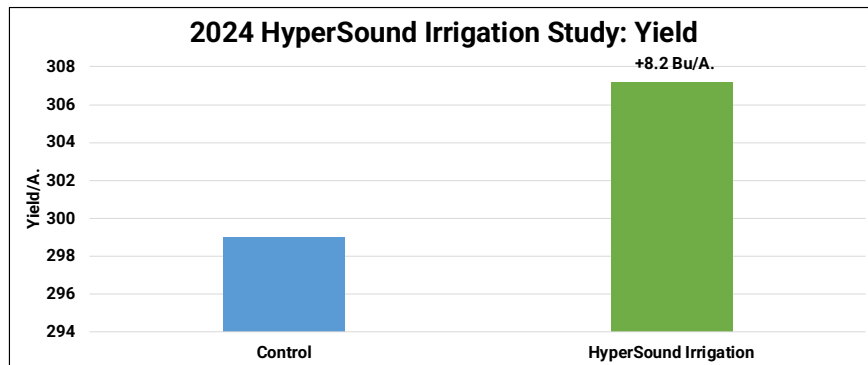

Planting Date: May 5<sup>th</sup>    Hybrid: Channel 215-09    Population: 36K    Row Width: 30"    Rotation: CAB    Corn Price: \$4.08

## High Management Strip Crop/Livestock Sustainability Study

**Objective:** To achieve high yield corn in an intense management environment that focuses on using strip-cropping corn, cover crops, and livestock. This sustainability study is intended for livestock to feed our crops and the crops to feed our livestock, while at the same time creating healthier soils.

30" row corn is planted in 10' alternating strips between a multi-species cover crop. The short stature cover crop allows the corn to capture more sunlight and to create the first step of a high yield environment.

The cover crop is then planted near June 1<sup>st</sup> and is allowed to establish tremendous root and top-growth and to utilize the long growing season, unlike traditional cover crop scenarios.

Three species of livestock are then placed in the cover crop strips in a mobile livestock confinement system called the StockCropper. Sheep are used as the first stage grazers in front of the StockCropper, mowing off much of the cover crop and using it as its stand-alone food ration. As the sheep are grazing, they also supply manure back into the soil. Secondly, hogs are placed in the center of the livestock unit, as a second source of manure being added back to the soil, as well as higher value meat product sold to increase farm revenue. Lastly, meat chickens are placed in the rear of the livestock unit and work as scavengers from the sheep and hogs, but also supply a 3<sup>rd</sup> species of manure. The StockCropper unit can autonomously or manually move through the cover crop strips to feed the livestock and distribute the manure uniformly.



Figure 1. Strip-Cropping Corn and Cover Crops



Figure 2. StockCropper Livestock Unit

## High Management Strip Crop/Livestock Sustainability Study

Figure 3. Sheep Grazing Cover Crops



Figure 4. Hogs in Center Bay



Figure 5. Meat Chickens in Rear Bay



## High Management Strip Crop/Livestock Sustainability Study

Another component to this high management study is water management. The trial area has NetAFim drip tape placed 14" deep on 40" centers to allow for irrigation throughout the growing season. Below the irrigation is 3" drainage tile on 30' centers placed 36" to the top of the tile to control excess water when soils are saturated. Field tile removes the water and temporarily holds the rainwater in a reservoir that can then be pumped out to re-cycle the rainwater through the irrigation system. Monthly testing of the reservoir is conducted to monitor for any nutrients in the water to evaluate leaching potential and/or any groundwater contamination.



Figure 6. NetAFim Surface Installed Drip tape

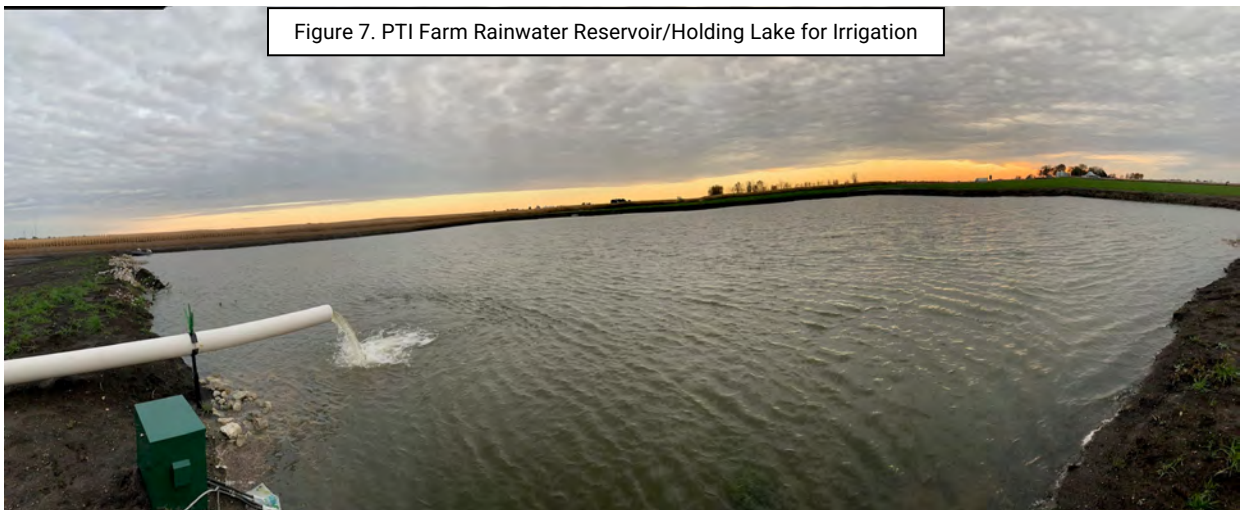

Figure 7. PTI Farm Rainwater Reservoir/Holding Lake for Irrigation

## High Management Strip Crop/Livestock Sustainability Study

The control in the study is dryland strip-till, non-strip-crop, average status quo managed corn planted at 36K, fertilized with 200# 18-46-0, 200# 0-0-60, 180# total nitrogen and a VT Miravis®Neo fungicide application.

The high management protocol is listed below. Items below represent **ALL** treatments that required additional costs over the control:

<p><b><u>Fall 2023 Residue Digestor/Soil Feeders:</u></b></p> <p>3 Gal QLF L-CBF BOOST, 3 Gal ATS</p>	<p><b><u>At-Plant Nutrition Conceal® Dual Band:</u></b></p> <p>2 Gal Nachurs K-Fuse®, 25 Gal 32% UAN, 3 Gal ATS, 2 Qts Boron, 10 Gal Green Lightning Plasma Activated Water(PAW)2 Gal Nachurs</p>
<p><b><u>Spring 2024 Pre-Plant:</u></b></p> <p>25# Smart Hydrogel soil water retainer</p> <p>20 Gal 32% UAN WNF,1 Qt APSA-80™ Water Adjuvant, 1 Qt PhycoTerra Microbial Food</p>	<p><b><u>At-Plant FurrowJet® 3-Way Band:</u></b></p> <p>1 Qt AgroLiquid LiberateCa®, 5 Gal PAW</p> <p>3 Gal Pritchard Ag Brix Builder, MicroPak, Humate and Sea Kelp</p>
<p><b><u>EZ Drop SideDress:</u></b></p> <p>V8 5 Gal ATS, 20 Gal UAN 32%, 2 Gal QLF L-CBF BOOST, 1 Qt Boron</p>	<p><b><u>Foliar Treatment:</u></b></p> <p>V3 Nachurs 1 Qt FinishLine® + 1 Gal K-Fuel®</p> <p>V3 4oz Corteva™ Fortified Stimulate Yield Enhancer Plus</p> <p>V10 Nachurs 1 Qt MoneyBall®</p> <p>VT: 13.7oz Miravis®Neo Fungicide, 2 Gal PAW</p> <p>VT: 3 Gal QLF L-CBF Amino 15, 1Qt Boron</p> <p>R3: 7oz Veltyma® Fungicide, 3 Gal PAW</p>
<p><b><u>Fertigation:</u></b></p> <p>June Irrigation: 2" water, 2 Gal ATS, 5 Gal 32%</p> <p>July Irrigation: 2.5" water, 2Gal ATS, 9 Gal32%</p> <p>August Irrigation: 2.25" Water, 1 Gal ATS, 6 Gal 32%</p> <p>September Irrigation: 1.25" Water</p>	

## High Management Strip Crop/Livestock Sustainability Study

**Results:** Table 1. illustrates yield results of all entries in the study. Pioneer® 1742Q topped the charts with a PTI Farm record yield of 434.9 Bu/A., ProHarvest 83P19 at 380.8 Bu/A. and Golden Harvest 14B32 at 358.4 Bu/A. These three hybrids out-yielded the control by an average of +141.4 Bu/A.

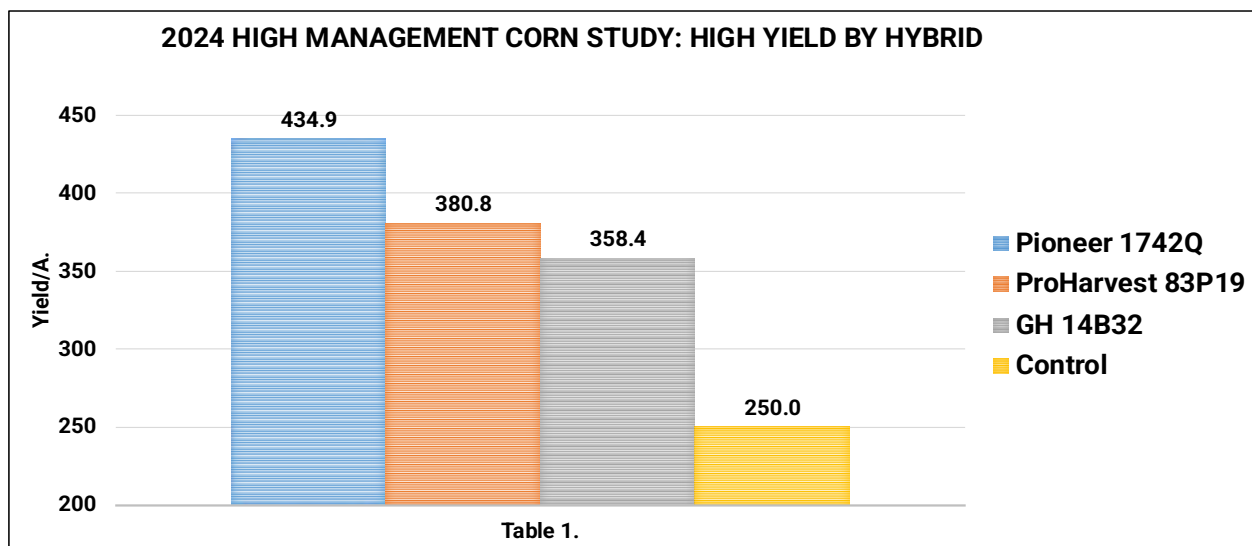

Table 2. summarizes high yield levels at the PTI Farm since its inception back in 2018. 2020 began our first full year of our water management program, where recycling of rainwater from field tile first was initiated.

Year	Hybrid	Corn Yield
2018	Pioneer 1197	272.5
2019	DeKalb 53-56	285.0
2020	DeKalb 63-42	368.2
2021	Golden Harvest 15J91	357.9
2022	Channel 212-04	398.4
2023	Pioneer 1742Q	403.7
2024	Pioneer 1742Q	434.9



## High Management Corn Strip Cropping Study

It is our goal at the PTI Farm for corn yield to be near 10 times our seeding rate. Table 3. below summarizes yield to seeding rate ratios. The control yield of 250 Bu/A. resulted in an average ratio of 6.9 Bu/1000 seeds planted (250/36). Pioneer 1742Q reached 10.1 Bu/1000, while 14B32 and 83P19 achieved 8.9 to 8.3 respectively.

One very important aspect to consider in any trial, especially a high managed corn trial, is economics. High yield trials simply have more costs and these costs to be paid for. If yield cannot be increased enough to pay the bills, it's simply not sustainable. High yields look great on paper and in the news, but we need bushels to pay for the additional cost of products we are applying.

Table 4. illustrates average net return for each corn hybrid, compared to the control. The high management program did in fact achieve positive net returns, with all three hybrids. Pioneer 1742Q achieved average profit of +\$367.74/A., ProHarvest 83P19 +\$173.19/A. and Golden Harvest 14B32 averaging +\$122.12/A. at

These returns indicate this high management study is sustainable and not only are we increasing

corn yield, but we are netting more dollars/A. Now the question is, how do we accomplish this on more acres and how do we continue to increase corn yield and/or profitability? As only a second year study, we are optimistic that the livestock aspect will be crucial to profitability in future years, as we expect soil test values to increase and soil biology to explode that will eliminate the need for costly nutrition expenditures going forward. When this happens, profits will soar. 2025 will be our 3<sup>rd</sup> study year and we hope to collect a true cost analysis of the livestock. It is our hope that the sale of livestock would replace any cost associated, as well as the replacement of soybeans that would normally be planted as a short crop next to the corn.

*Planting Date: April 28<sup>th</sup> Hybrids: P1742Q, GH 14B32, ProHarvest 83P19 Population: 38-40K Row Width: 30" Rotation: CACover Corn Price: \$4.08*

*High Yield Program Cost: \$367.74/A. or 90.1 Bu/A. Break-Even*

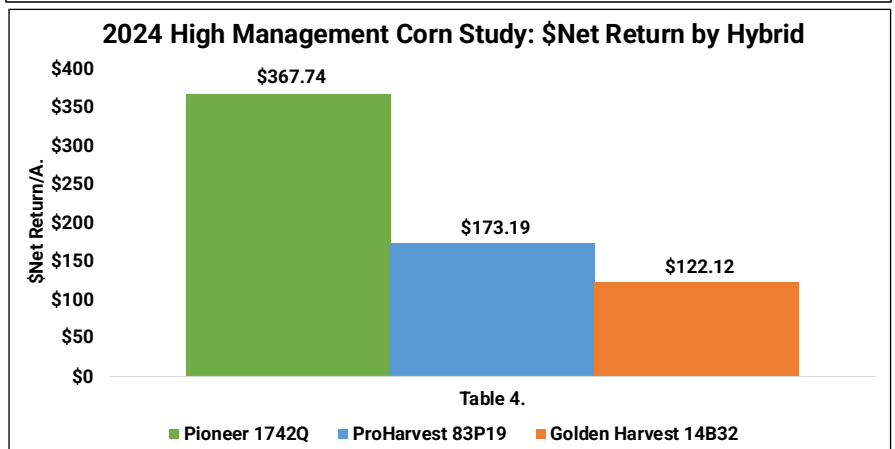
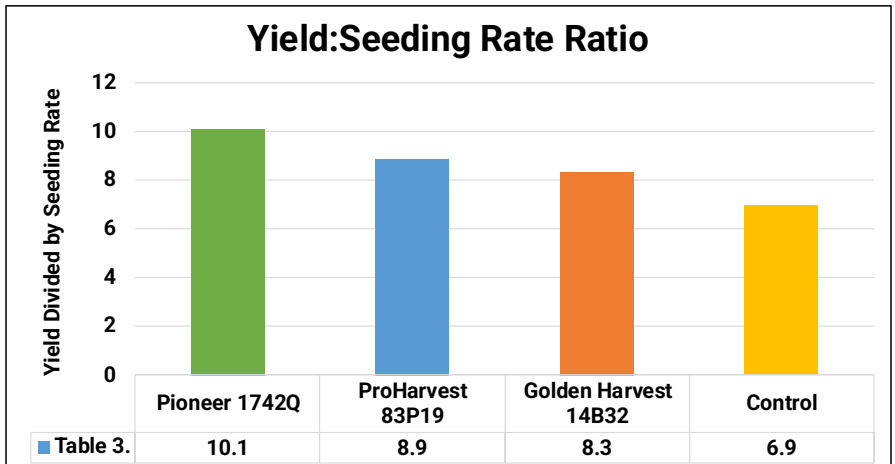

## AgroLiquid® High Management Corn Study

**Objective:** To evaluate the yield and economic impact of a corn liquid starter fertilizer and foliar nutritional program from AgroLiquid in a high management dryland and irrigated environment. This trial consisted of the following:

### Treatments and Placement:

<b>#1. Control:</b>	200# DAP, 200# 0-0-60, Less R3 Fungicide, less 40# N
<b>#2 At-Plant Fertility:</b>	
Conceal® Dual Band: (Figure 1.)	3 Gal/A. accesS™, 27 Gal/A. 32% UAN
FurrowJet®: (Figure 2.)	2 Gal/A. ProGerm®, 1 Gal/A. Nresponse® 0.75 Gal/A. Micro500™, 2 Gal/A. SureK® 0.25 Gal/A. Boron, 0.25 Gal/A. LiberateCa™ 0.125 gal/A. Manganese
<b>#3 Post-Plant Applications:</b>	
V4: SideDress:	2 Gal/A. accesS™, 1 Gal/A. Kalibrate™, 0.125 Gal/A. Boron
VT: 1 Gal	1 Gal/A. FertiRain™, 0.125 Gal/A. Boron 0.125 Gal/A. Manganese, 1 Gal/A. Nresponse®



Figure 1. Conceal Placement

Figure 2. FurrowJet® Placement



## AgroLiquid® High Management Corn Study Continued

All controls were planted at 36K seeding rates, while high management treatments were evaluated at 38k seeding rates using ProHarvest 79P87. Controls received -40# N (180# total N) and only one (VT) foliar fungicide pass, and 200# 18-46-0 and 200# 0-0-60.

Irrigation on all treatments received 9.25" water throughout the growing season. High yield treatments received 13.7oz/A. of Miravis® Neo at VT and 13.7oz/A. of TrivaPro® at R3 growth stage, +40 additional N units and 30 Gal/A. plasma activated water conditioner.

**Results:** 2024 proved to offer rainfall deficit of nearly -7 inches compared to normal. This made irrigation demand very critical to maximize yield and overall response of the high management program. Stand-alone irrigation offered the largest individual yield gain in the study at +52.2 Bu/A., with corresponding net economic returns of +\$108.83/A.

The cost of the high management program required a 23 Bu/A. advantage to break even. Dryland treatments responded with gains of +18.1 Bu/A. and led to a negative net return of **-\$10.92/A.** Irrigated

treatments responded with yield gains of +28.3 Bu/A. leading to net gains of +\$30.69/A.

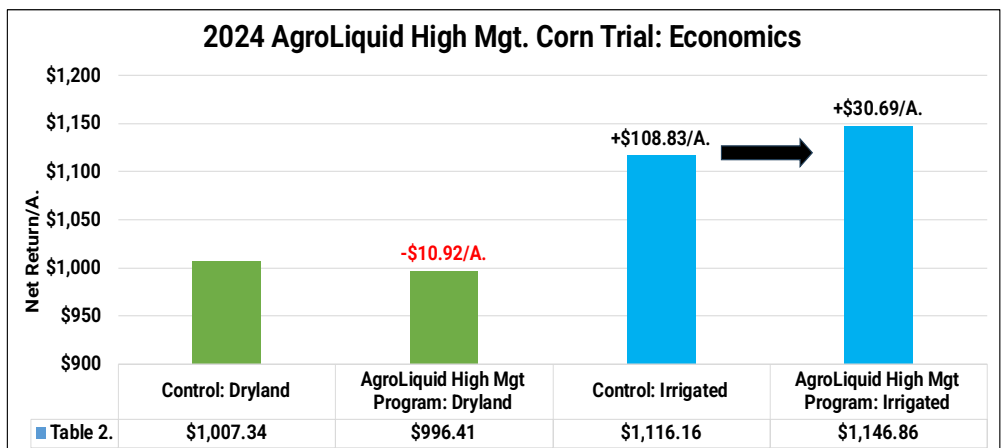
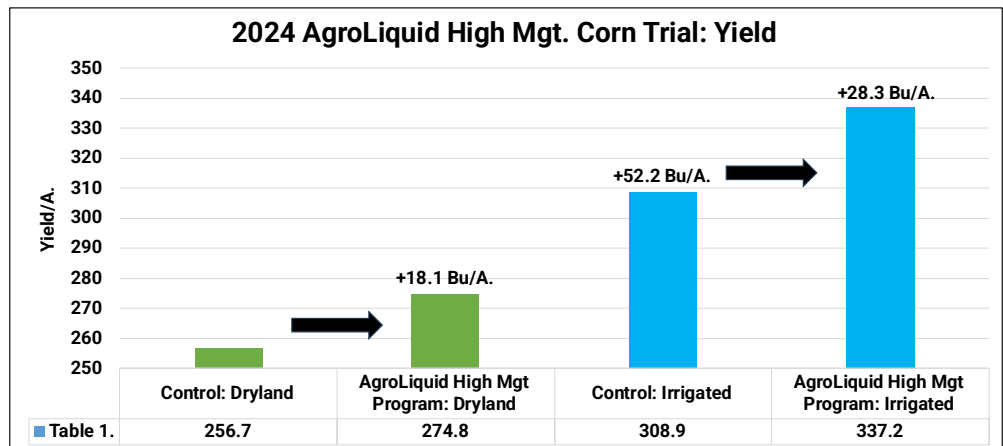

Planting Date: April 27<sup>th</sup>

Hybrid: ProHarvest 79P87

Population: 36-38K

Row Width: 30"

Rotation: CAB

Corn Price: \$4.08

Conceal® Program: \$18.30/A.

FurrowJet® Program: \$63.43/A.

SideDress + Foliar Program: \$43.04/A.

Fert Re-Allocation: \$40/A.

N Price: \$0.58/#

Base Irrigation Program: \$104.15/A.

## Marco Fertilizer High Management Corn Study

**Objective:** To evaluate the yield and economic impact of a corn liquid starter fertilizer and foliar nutritional program from Marco Fertilizer in a high management dryland and irrigated environment. This trial consisted of the following:

**Treatments and Placement:**

<b>#1. Control:</b>	200# DAP, 200# 0-0-60, Less R3 Fungicide, less 40# N
<b>#2 At-Plant Fertility:</b>	
Pre-Emerge:	16oz/A. Soil Assist
FurrowJet® 3-Way: (Figure 1.)	3 Gal/A. QuickGrow Complete 1oz/A. MycoBoost with 3 Gal/A. Water
<b>#3 Foliar Applications :</b>	
	V4: 1 oz/A. Poseidon 20 oz/A. Energizer 1 pt/A. Iron Plus Post Herbicide
	V10: 1 oz/A. Poseidon 20 oz/A. Energizer 2# Foliar Complete 5 gal/A. Y-MAXX
	VT: 20 oz/A. Energizer 2# Foliar Complete 32 oz/A. Calcium Plus
	R3: 2.5 gal/A. Finisher + 20 Gal/A. Water

Figure 1. FurrowJet® Placement



## Marco Fertilizer High Management Corn Study

All controls were planted at 36K seeding rates, while high management treatments were evaluated at 38k seeding rates using Golden Harvest 14B32. Control received -40# N (180# total N) and only one (VT) foliar fungicide pass, and 200# 18-46-0 and 200# 0-0-60.

Irrigation on all treatments received 9.25" water throughout the growing season. High yield treatments received 13.7oz/A. of Miravis® Neo at VT and 13.7oz/A. of TrivaPro® at R3 growth stage, +40 additional N units and 30 Gal/A. plasma activated water conditioner.

**Results:** Golden Harvest 14B32 posted highest yield of 293.1 in the combination irrigated/planter nutrition/and foliar program, +62.0 Bu/A. over the dryland control.

Irrigation itself resulted in individual gains in the study at +36.5 Bu/A. over the dryland control, resulting in net returns of +\$44.77/A.

At-Plant treatments captured +10.2 Bu/A. gains with a positive return of +\$44.79/A. over the irrigated control.

Combination at-plant and foliar treatments captured +25.3 Bu/A. gains, however positive economic gains of +\$38.53/A. over the irrigated control.

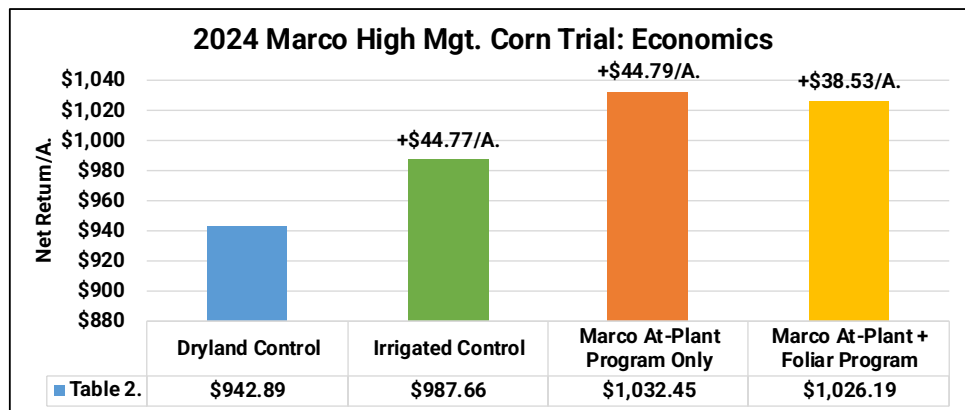
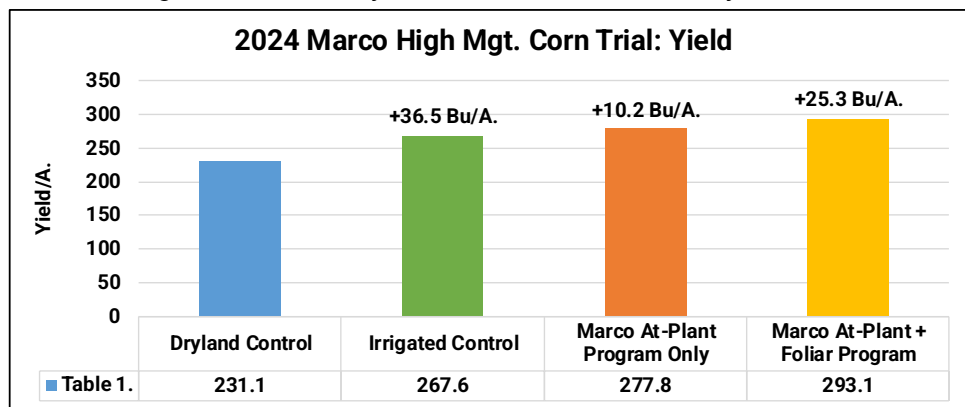

Planting Date: May 9<sup>th</sup>

Hybrid: Golden Harvest 14B32

Population: 36-38K

Row Width: 30"

Rotation: CAB

Corn Price: \$4.08

At-Plant Conceal® and FurrowJet Program: \$36.83/A.

Post Program: \$68.69/A.

Base Irrigation Program: \$104.15/A.

Fert Re-Allocation: \$40/A.

## Corteva™ Biological High Management Corn Study

**Objective:** To evaluate the yield and economic impact of a corn liquid starter fertilizer and foliar nutritional program from Corteva Biologicals in a high management dryland and irrigated environment. This trial consisted of the following:

### Treatments and Placement:

<b>#1. Control:</b>	200# DAP, 200# 0-0-60, R1 Fungicide, -40# N
<b>#2 At-Plant Fertility:</b>	
Conceal® Dual Band (Figure 1.)	1Qt/A. Harvest Plus™
FurrowJet® (Figure 2.)	4oz/A. Fortified Stimulate Yield Enhancer® Plus
<b>#3 Foliar Applications:</b>	
	V4: 6oz Fortified Stimulate Yield Enhancer® Plus
	V4: 5oz Utrisha™ N
	V4: 1Qt/A. Harvest Plus™
	VT: 1Qt/A. Sugar Mover® Premier,
	VT: 8oz/A. Xcyte™
	VT: 2.5# Harvest More® Urea Mate®

Figure 1. Conceal Placement

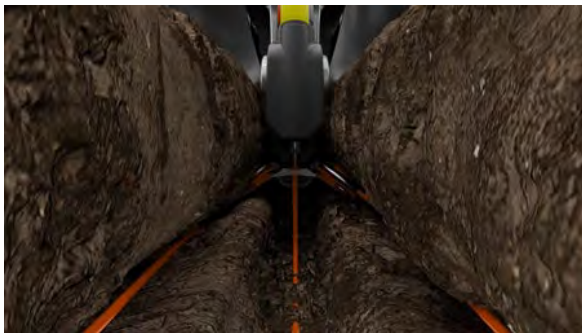

Figure 2. FurrowJet® Placement



## Corteva™ Biological High Management Corn Study

All controls were planted at 36K seeding rates, while high management treatments were evaluated at 38k seeding rates using Pioneer 13476Q. Control received -40# N (180# total N) and only one (VT) foliar fungicide pass, and 200# 18-46-0 and 200# 0-0-60.

Irrigation on all treatments received 9.25" water throughout the growing season. High yield treatments received 13.7oz/A. of Miravis® Neo at VT and 13.7oz/A. of TrivaPro® at R3 growth stage, +40 additional N units and 30 Gal/A. plasma activated water conditioner.

**Results:** Pioneer 13476Q posted highest yield of 288.1 in the combination irrigated/planter nutrition/and foliar program, +46.9 Bu/A. over the dryland control.

Irrigation resulted in the largest individual yield gains in the study at +31.4 Bu/A. over the dryland control, resulting in net returns of +\$23.96/A.

At-Plant treatments captured +8.1 Bu/A. gains with a positive return of +\$61.49/A. over the irrigated control. These net returns proved highest of all treatments.

Combination at-plant and foliar treatments captured +15.5 Bu/A. gains with a positive return of +\$47.09/A. over the irrigated control.

Even though irrigation posted highest individual yield gains, a solid nutritional program continued to enhance overall return by 2 to 2.5 times.

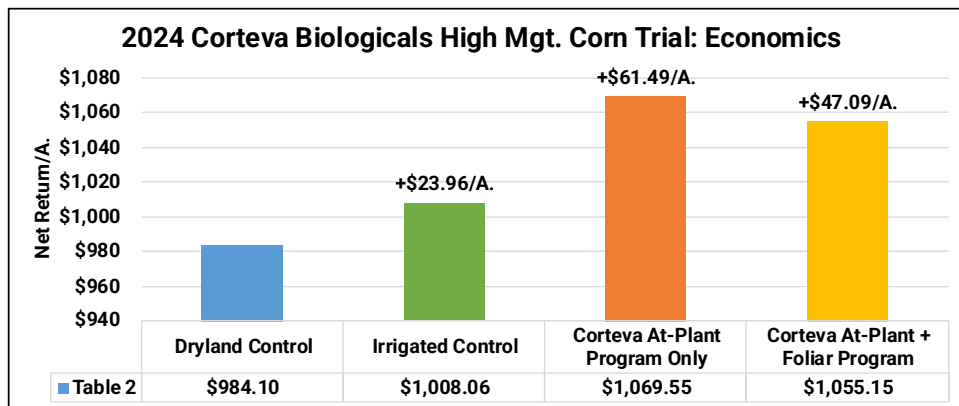
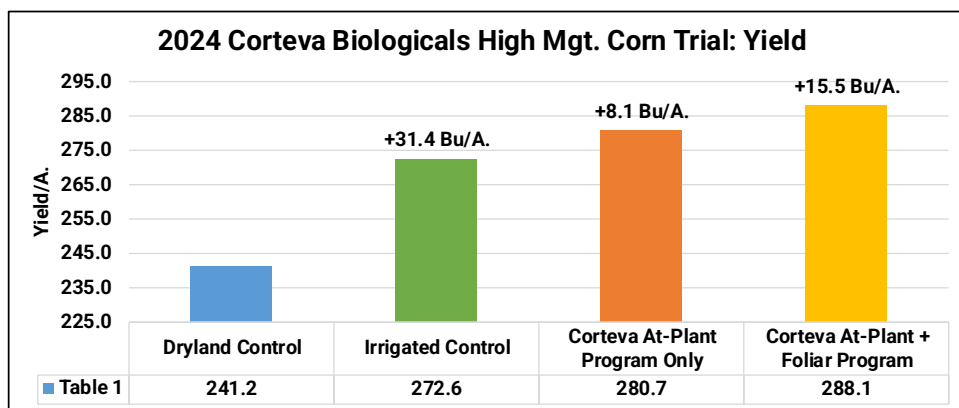

Planting Date: May 9<sup>th</sup>

Hybrid: Pioneer 13476Q

Population: 36K

Row Width: 30"

Rotation: CAB

Corn Price: \$4.08

At-Plant Conceal® and FurrowJet Program: \$11.56/A.

Post Program: 44.59/A.

Base Irrigation Program: \$104.15/A.

Fert Re-Allocation: \$40/A.

## QLF® High Management Irrigated Corn Study

**Objective:** To evaluate the yield and economic impact of a corn liquid starter fertilizer and foliar nutritional program in a high management irrigated environment. This trial consisted of the following:

### Treatments and Placement:

<b>Control:</b>	200# DAP, 200# 0-0-60, R1 Fungicide, -40# N
<b>At-Plant Fertility:</b>	
FurrowJet® Tri-Band: (Figure 1.)	5.125 Gal/A. L-CBF 7-21-3 1.5 Qt/A. Corn Spike 1 Pt/A. Kelpak
Conceal® Dual Band (Figure 2.)	3 Gal/A. BOOST + 9 Gal/A. UAN 32%
Pre-Plant Weed-N-Feed	17 Gal/A. UAN 32% + 3 Gal/A. BOOST
<b>Post Plant Applications:</b>	
	V3: 3 Gal/A. Amino15 + 1 Qt/A. PowerAid + 1Pt/A. Kelpak
	V4 Sidedress: 3 Gal/A. BOOST + 17 Gal/A. UAN 32%
	V8: 3 Gal/A. L-CBF 5-5-5-1S
	V10 Sidedress: 1 Gal/A. EZ Drop BOOST + 9 Gal/A. UAN
	V12 Sidedress: 1 Gal/A. EZ Drop BOOST + 9 Gal/A. UAN
	VT: 3 Gal/A. Amino15 + 1 Qt/A. PowerAid + 1Pt/A. Kelpak
	R3: 3 Gal/A. L-CBF 5-5-5-1S



Figure 1. FurrowJet® Placement

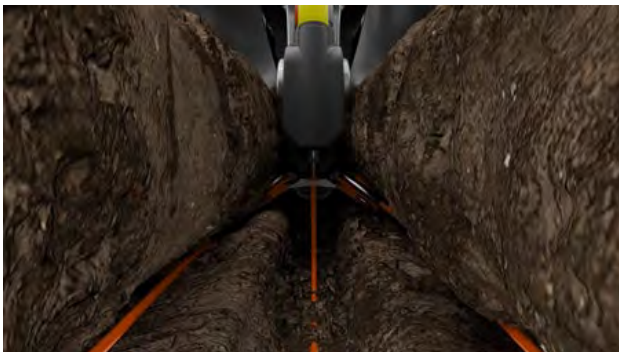

Figure 2. Conceal® Dual Band Application





## QLF® High Management Irrigated Corn Study.

**Results:** All controls were planted at 36K seeding rates, while high management treatments were evaluated at 38k seeding rates using Channel 214-78. Control received -40# N (180# total N) and only one (VT) foliar fungicide pass, and 200# 18-46-0 and 200# 0-0-60.

Irrigation on all treatments received 9.25" water throughout the growing season. High yield treatments received 13.7oz/A. of Miravis® Neo at VT and 13.7oz/A. of TrivaPro® at R3 growth stage, +40 additional N units and 30 Gal/A. plasma activated water conditioner.

**Results:** 2024 proved to offer rainfall deficit of nearly -7 inches compared to normal. This made irrigation demand very critical to maximize yield and overall response of the high management program. Stand-alone irrigation offered the largest individual yield gain in the study at +40.7 Bu/A., with corresponding net economic returns of +\$62.06/A.

The cost of the QLF high management program required a 23 Bu/A. advantage to break even. Dryland treatments responded with gains of +26.7 Bu/A. and led to a positive net return of +\$14.53/A. Irrigated treatments responded with yield gains of +25.2 Bu/A. leading to net gains of +\$8.41/A.

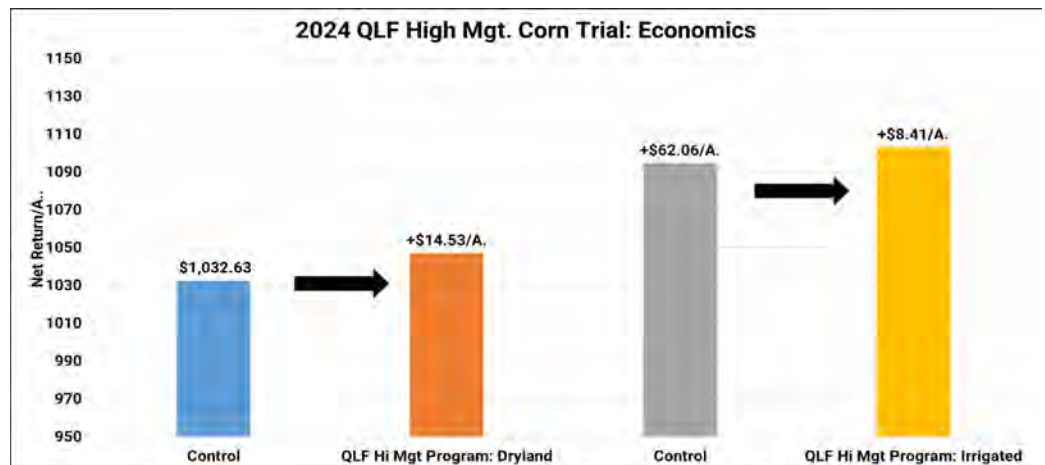
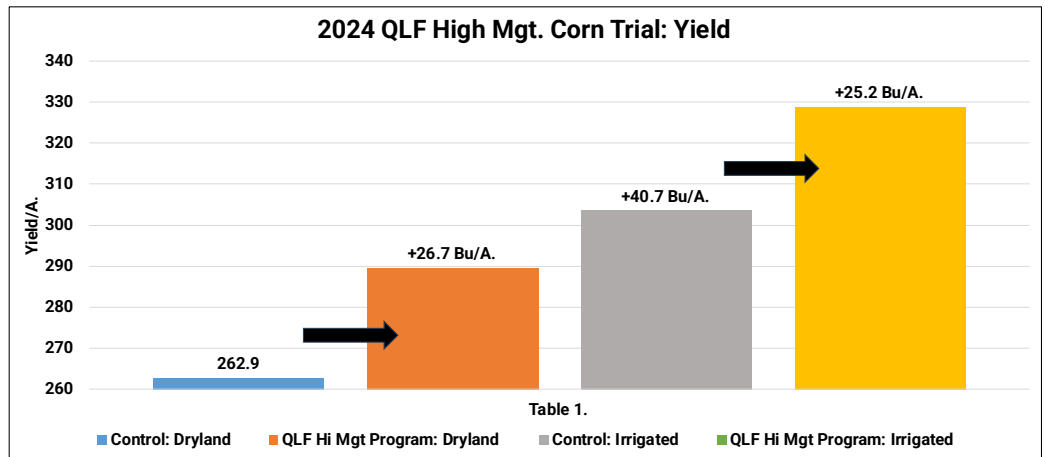

Planting Date: May 9<sup>th</sup> Hybrid: Channel 214-78 Population: 36-38K Row Width: 30" Rotation: CAB Corn Price: \$4.08 Conceal® Program: \$11.25/A.  
FurrowJet® Program: \$37.04/A. SideDress + Foliar Program: \$83.55/A Fert Re-Allocation: \$40/A Base Irrigation Program: \$104.15/A.

## Nachurs® Fertilizer High Management Nutritional Study

**Objective:** To evaluate the yield and economic impact of a corn liquid starter fertilizer and foliar nutritional program from Nachurs® in a high management irrigated environment. This trial was designed as a high management program designed for maximum potential yield. Treatments consisted of the following:

### Treatments and Placement:

<b>#1. Control:</b>	200# DAP, 200# 0-0-60, Less R3 Fungicide, less 40# N
<b>#2 At-Plant Fertility:</b>	
Conceal® Dual Band (Figure 1.)	27 Gal/A. UAN, 3 Gal Throwback®, 1 Qt Sideswipe®, 1 Qt Microzone Ca®
FurrowJet® Center: (Fig. 2.)	1 Pt RhyzoLink® PE, 1Qt FaceOff®, 1oz NLT 5.1, 2 Qt K-fuel®
FurrowJet® Wings: (Fig. 2.)	3.5 Gal First Down®, 2 Qt K-flex®
<b>#3 Foliar + SideDress Applications:</b>	
	V4: 1Qt FinishLine®, 1oz Enduro-Shield®
	V8: EZ-Drop SideDress 30 Gal UAN, 2 Gal K-flex® Max, 1 Qt Sideswipe®
	VT: 1 Gal TripleOption®+ 1.5 pt MoneyBall® 13.7oz Miravis®Neo
	R2: 1.5Gal NockOut®, 1Qt/A. FinishLine®, 7oz Veltyma

Figure 1. Conceal® Dual Band Placement



Figure 2. FurrowJet® Placement



## Nachurs® Fertilizer High Management Nutritional Study

Irrigation on all treatments received 9.25" water throughout the growing season.

Control replications received 200# each of 18-46-0 and 0-0-60 applied in the fall in a strip-till band and Miravis®Neo was applied at VT growth stage. High managed treatments received the full Nachurs program, plus an additional R3 Veltyma® fungicide.

**Results:** Pioneer® 1742Q tag teamed with the Nachurs nutritional program to offer exceptional yields of 377.0 Bu/A. in the high management program, an additional +31.6 Bu/A. over the control.

These yield gains equated to a positive net return on investment of +\$62.61/A. With the high yields, net revenue reached near \$1400/A.

To offset the cost of the high management program, a break-even yield increase of +16.2 Bu/A. was needed. Actual yield received was nearly double at +31.6 Bu/A.

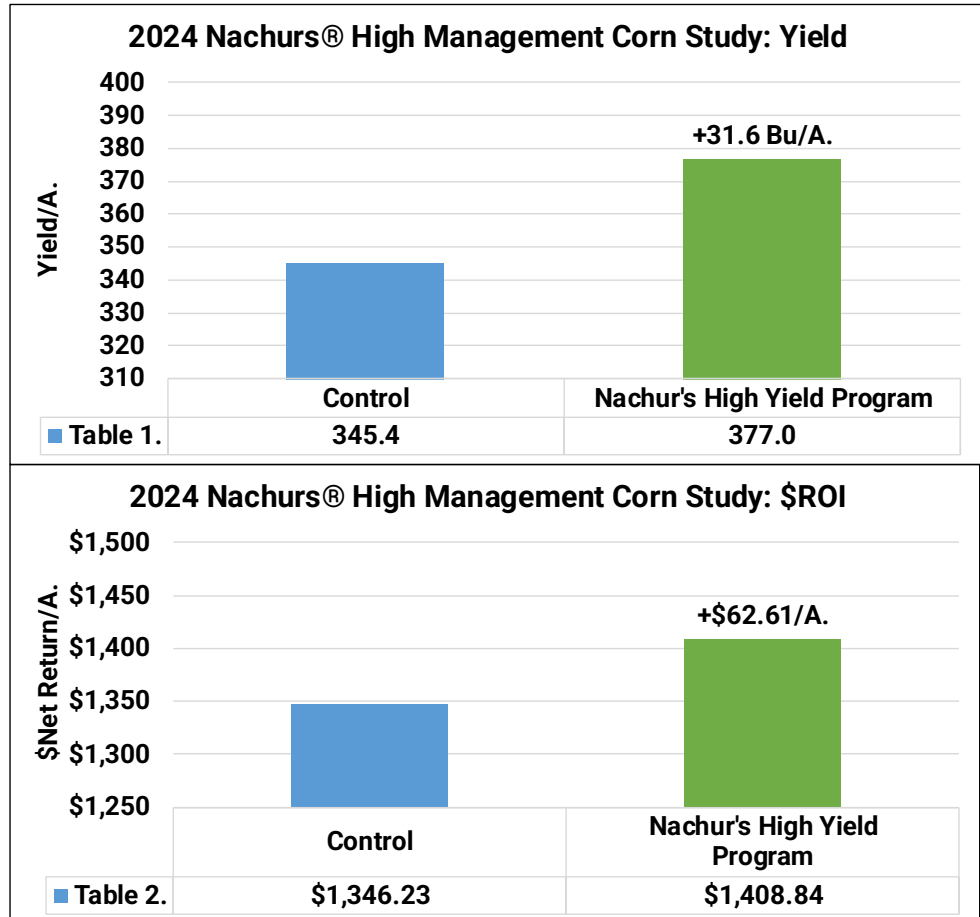

Planting Date: May 8<sup>th</sup>    Hybrids: Pioneer 1742Q    Population: 38K    Row Width: 30"    Rotation: CAC, Strip-Till    Corn Price: \$4.08    Total N: 299#

Conceal® Program: \$18.76/A.    FurrowJet® Program: \$36.35/A.    Fertilizer Re-Allocation: \$63/A    Side-Dress + Foliar Program: \$74.11/A.

## Nutrient Management Solutions High Management Corn Study

**Objective:** To evaluate the yield and economic impact of a Corn liquid starter fertilizer and foliar nutritional program from Nutrient Management Specialists (NMS) in a high management irrigated environment. This trial consisted of the following:

### Treatments and Placement:

<b>#1. Control:</b>	200# DAP, 200# 0-0-60, Less R3 Fungicide, less 40# N
<b>#2 At-Plant Fertility:</b>	
HopperBox Treatment :	1oz Envirozyme, 1oz, MycroGold Dust
FurrowJet® Center: (Figure 1.)	24oz High Energy Fish, 24oz. Sea Crop, 1oz Kelp, 1oz Fulvic Acid, 16oz AgroVive Ion XF, 16oz Dakota Boss B4 16oz Phenom®
FurrowJet® Wings: (Figure 1.)	4oz Spectra, 32oz Sea Crop, 1oz Seeder Heater, 16oz 5-Way Sweetener, 1oz Yucca, 0.5oz Molly, 4oz ZnSO4 32%, 4oz MnSO4, 32oz 9-45-15, 16oz Growthful
Conceal® Dual Band: (Figure 2.)	64oz 9-45-15 + Micros
<b>#3 Foliar Applications:</b>	
	V8: 10oz Macrosorb, 16oz 20-20-20 + Micros, 16oz 9-45-45 +Micros, 1 oz Kelp, 1oz Yucca, 24oz High Energy Fish, 24oz Sea Crop, 2oz Molly, 4oz ZnSO4 32%, 4oz MnSO4 32%, 1oz Fulvic, 12.8oz 5 Way Sweetener, 5oz Aloe, .5oz Seeder Heater, 32oz Potassium Acetate, 4oz Envirozyme

Figure 1. FurrowJet® Placement



Figure 2. Conceal® Dual Band Placement



## Nutrient Management Solutions High Management Corn Study

All controls were planted at 36K seeding rates, while high management treatments were evaluated at 38k seeding rates. Control received -40# N (180# total N) and only one (VT) foliar fungicide pass, and 150# 18-46-0 and 200# 0-0-60.

Irrigation on all treatments received 9.25" water throughout the growing season. High yield treatments received 13.7oz/A. of Miravis® Neo at VT and 13.7oz/A. of TrivaPro® at R3 growth stage, +40 additional N units and 30 Gal/A. plasma activated water conditioner.

**Results:** Irrigation itself resulted in individual gains in the study at +31.4 Bu/A. over the dryland control, resulting in net returns of +\$23.96/A.

At-Plant treatments resulted in yields of 298.1 Bu/A., +8.1 Bu/A. over the control. At-plant + foliar combination treatments pushed yield to 308.4 Bu/A., +19.1 Bu/A. over the control.

After all costs and application, at-plant nutritional treatments proved economic gains of +\$61.49/A., while the foliar/at-plant combination treatments tallied returns of +\$94.83/A.

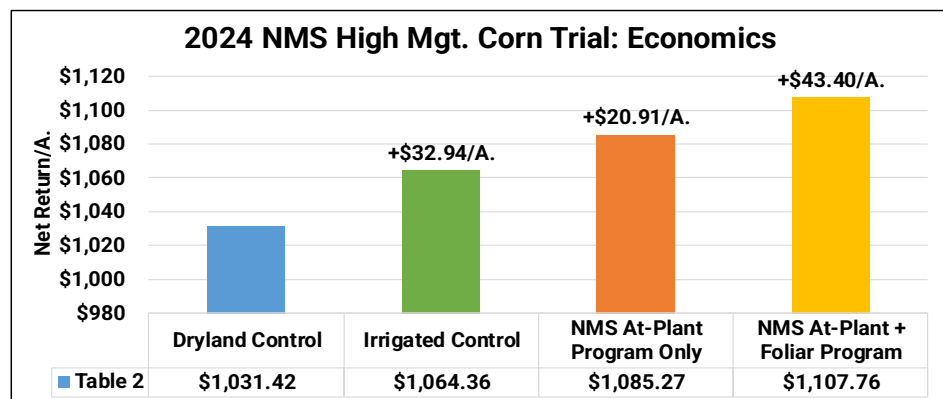
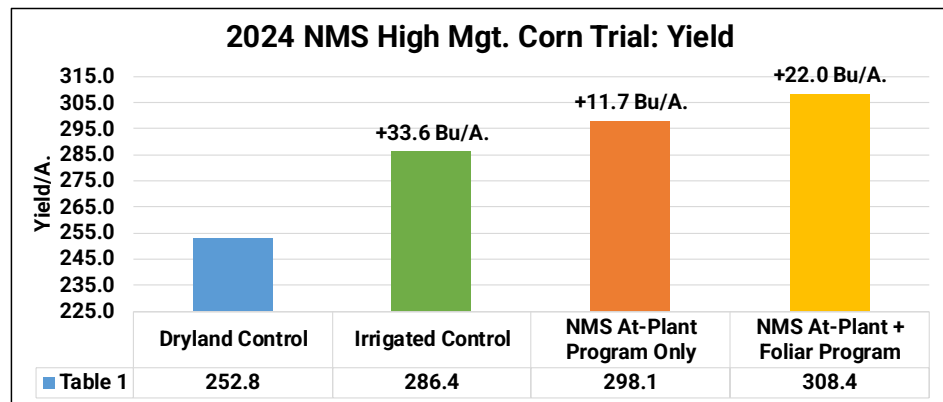

Planting Date: April 20<sup>th</sup>    Hybrid: Channel 214-78    Population: 38K    Row Width: 30"    Rotation: CAB    Corn Price: \$4.08    Irrigation: \$104.15/A.

HopperBox Treatment: \$7.41/A.    At-Plant Program: \$53.79/A.    Foliar Program: \$19.53/A.    100# DAP,100# Potash: \$82/A.

## NewFields Ag™ High Management Corn Study

**Objective:** To evaluate the yield and economic impact of a Corn liquid starter fertilizer and foliar nutritional program from NewFields Ag™ in a high management irrigated environment. This trial consisted of the following:

### Treatments and Placement:

<b>#1. Control:</b>	200# DAP, 200# 0-0-60, Less R3 Fungicide, less 40# N
<b>#2 At-Plant Fertility:</b>	
HopperBox Treatment :	Bio-Stealth with Provide-R PM
FurrowJet® Center: (Figure 1.)	16 oz/A. Phenom
FurrowJet® Wings: (Figure 1.)	16 oz/A. Growthful 1 Qt/A. Frenzy
Conceal® Dual Band: (Figure 2.)	5 Gal 10-34-0 16 oz/A. Growthful
<b>#3 Foliar Applications:</b>	
	V3: 1 Qt/A. Frenzy 2 Oz/A. Cary-R MA
	V10: 1 Qt Frenzy

Figure 1. FurrowJet® Placement



Figure 2. Conceal® Dual Band Placement



## NewFields Ag™ High Management Corn Study

All controls were planted at 36K seeding rates, while high management treatments were evaluated at 38k seeding rates. Control received -40# N (180# total N) and only one (VT) foliar fungicide pass, and 150# 18-46-0 and 200# 0-0-60.

Irrigation on all treatments received 9.25" water throughout the growing season. High yield treatments received 13.7oz/A. of Miravis® Neo at VT and 13.7oz/A. of TrivaPro® at R3 growth stage, +40 additional N units and 30 Gal/A. plasma activated water conditioner.

**Results:** Irrigation itself resulted in individual gains in the study at +35.1 Bu/A. over the dryland control, resulting in net returns of +\$39.06/A.

At-Plant treatments resulted in yields of 294.8 Bu/A., +14.2 Bu/A. over the control. At-plant + foliar combination treatments pushed yield to 301 Bu/A., +20.4 Bu/A. over the control.

After all costs and application, at-plant nutritional treatments proved economic gains of +\$64.76/A., while the foliar/at-plant combination treatments tallied returns of +\$46.98/A.

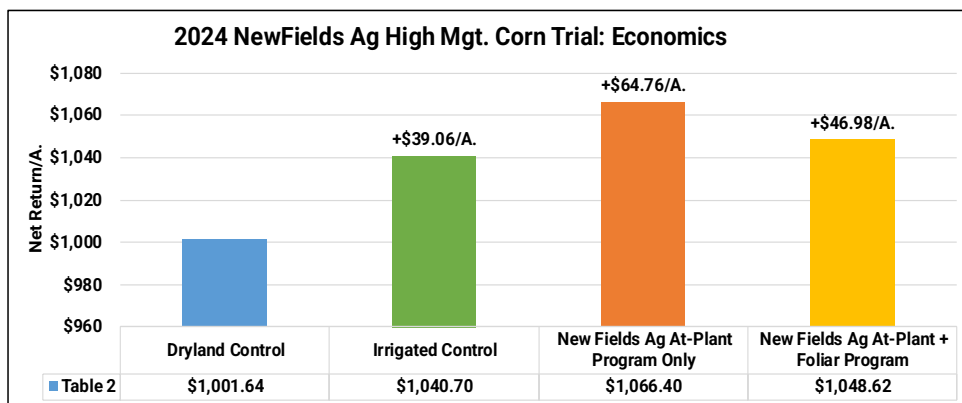
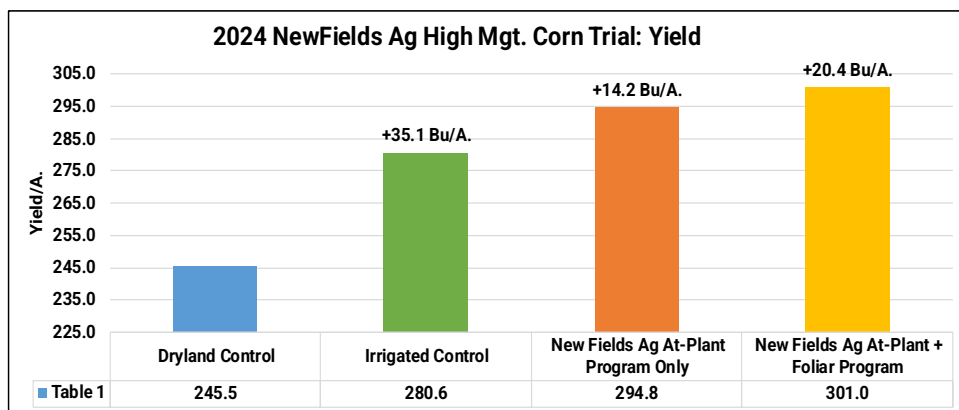

Planting Date: April 20<sup>th</sup> Hybrid: Wyffels 7945 Population: 38K Row Width: 30" Rotation: CAB Corn Price: \$4.08 Irrigation: \$104.15/A.

HopperBox Treatment: \$14.75/A. At-Plant Program: \$57.48/A. Foliar Program: \$43.08/A. 100# DAP,100# Potash: \$82/A.

## AgXplore® High Management Corn Study

**Objective:** To evaluate the yield and economic impact of a corn liquid starter fertilizer and foliar nutritional program from AgXplore® in a high management irrigated environment. This trial consisted of the following:

### Treatments and Placement:

<b>#1. Control:</b>	200# DAP, 200# 0-0-60, Less R3 Fungicide, less 40# N
<b>#2 At-Plant Fertility:</b>	
FurrowJet® Center: (Figure 1.)	2 Qt. Upward 1-0-0 with Fulvic Acid, Humic Acid
FurrowJet® Wings: (Figure 1.)	1 Qt Octane™ 1-0-0 with Fructose, Dextrose
<b>#3 Foliar Applications</b>	V5: 1 Qt. ArchiTech 10-5-5-0.05B-0.23Cu-0.11Mn-0.001Mo-0.20 Zn V5: 1 Qt. XR <sup>5</sup> -KSB 4-0-20-5S-0.5B

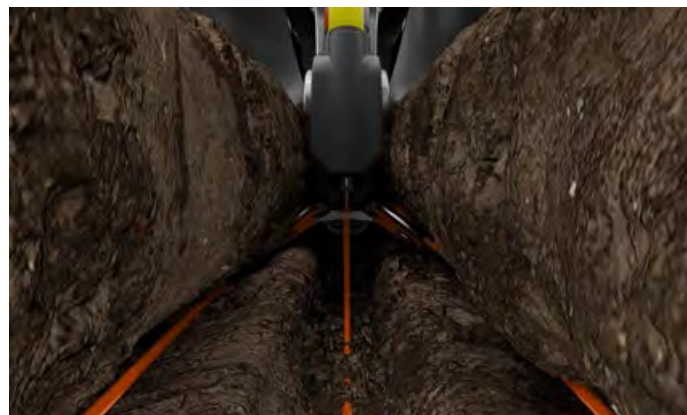



## AgXplore® High Management Corn Study

All controls were planted at 36K seeding rates, while AgXplore® treatments were evaluated at 38K seeding rates using Pro Harvest 81P20.

Irrigation on all treatments received 9.25" water throughout the growing season. All treatments received 13.7oz/A. of Miravis® Neo at VT and 13.7oz/A. of TrivaPro® at R3 growth stage.

**Results:** Pro Harvest 81P20 tallied yields averaging from 248.3 to 296.6 Bu/A. Irrigation alone proved yield increases of +35.5 Bu/A. At-Plant only treatments increased yield by +9.8 Bu/A. over the irrigated control, and corresponding net return of +\$62.48/A. The full At-Plant and Foliar treatments picked up +12.8 Bu/A. and net returns of +\$56.22/A.

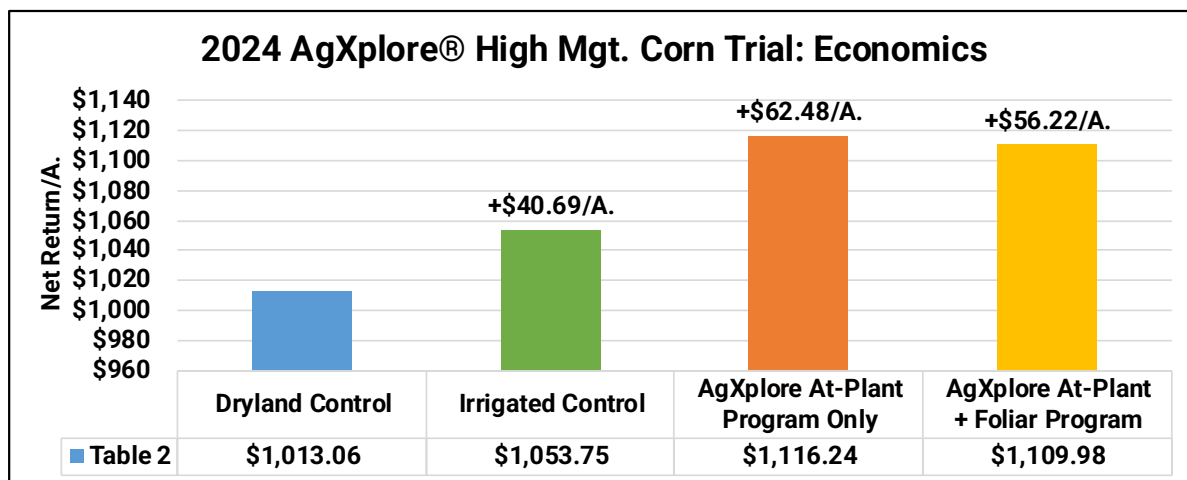
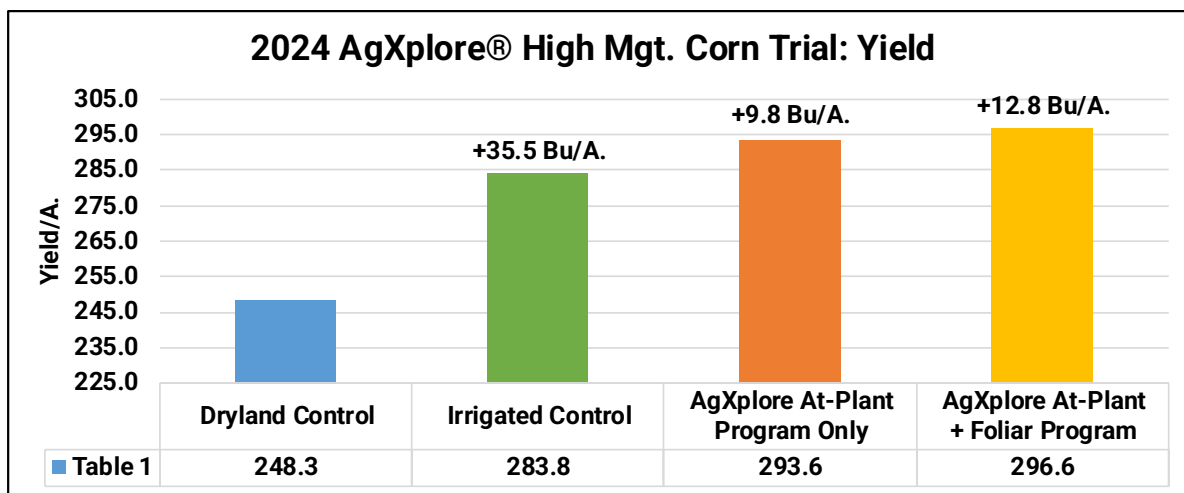

Planting Date: May 25<sup>th</sup>

Hybrid: Pro Harvest 81P20

Population: 36K,38K

Row Width: 30"

Rotation: CAC

Corn Price: \$4.08

At-Plant Program: \$17.50/A.

Foliar Program: \$18.50/A.

All Treatments Cost: \$104.15/A.

\$40 Fert Reallocation

## Golden Harvest® Genetics Study

**Objective:** To monitor the performance of three different Golden Harvest® hybrids and how they respond to different variables such as population, management, and environment changes. For this study we tested GH14B32, GH12U11, and GH03U08 hybrids at both 32K and 38K seeding rates. We implemented four different management styles on each of these hybrids, at each of the respected populations.

1. 100% Weed-N-Feed (WNF) + NO Fungicide
2. WNF + Planter Applied N + NO Fungicide
3. WNF + Side-Dress N + No Fungicide
4. WNF + Planter Applied N + Side-Dress N + Fungicide

**Results:** Table 1. illustrates that at the low 32K seeding rate, we had yield increases at all the different management practices. When we performed the highest level of management, we picked up the most yield, gaining +18.4 Bu/A. over that of the control. Table 2. then illustrates economic return in this study, while all treatments were profitable, the planter applied nitrogen + no fungicide achieved economic optimum at +\$37.26/A.

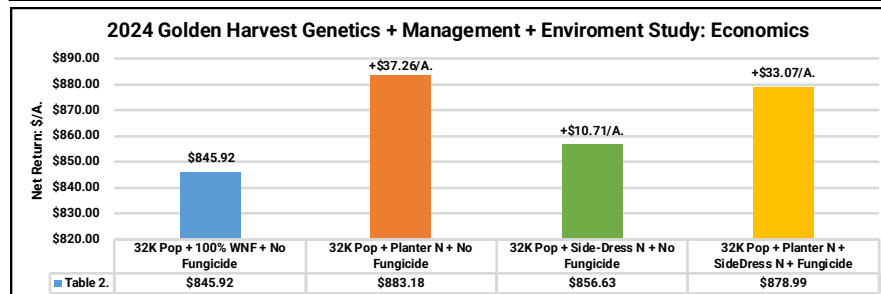
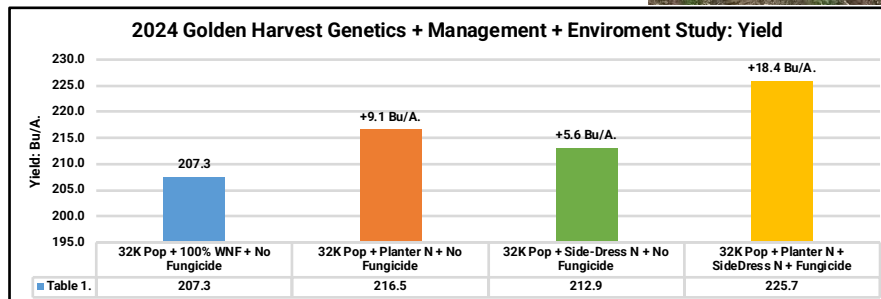

## Golden Harvest® Genetics Study

Tables 3. and 4. represent the same treatments but at a 38K seeding rate. We see the same trend in both populations – the highest yield is obtained at the full management program. Planter N only treatments picked up +12.5 Bu/A. yield gains, sidedress N +6.6 Bu/A., and full management program resulted in yield gains of +20.6 Bu/A. As for economics, the highest net profit was obtained at the planter nitrogen program only at +\$51.00/A.

We can concur with both populations that we saw the greatest yield increase at the full management level. As for economics, at both populations, the highest economic return was obtained at the planter nitrogen only, due to the added cost of fungicide and sidedress applications.

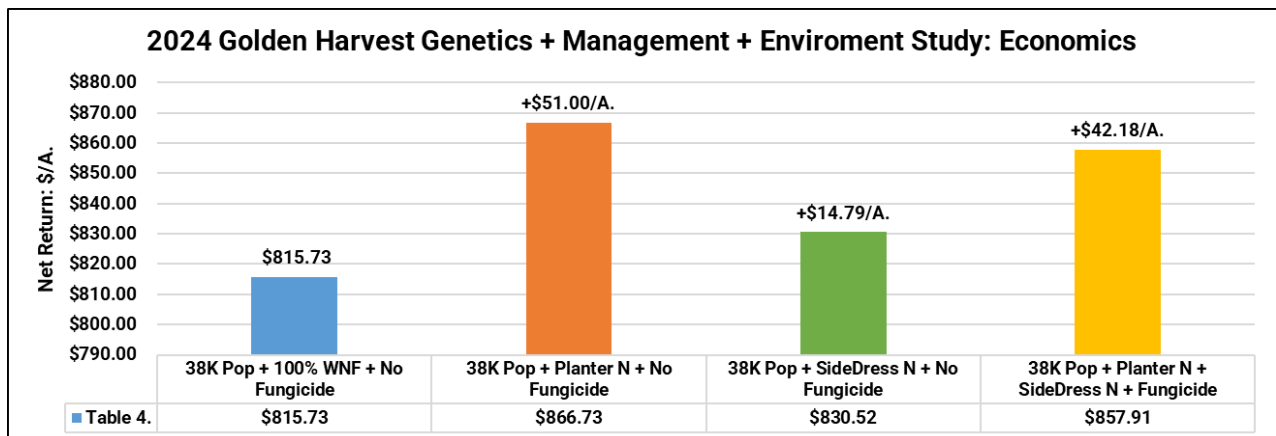
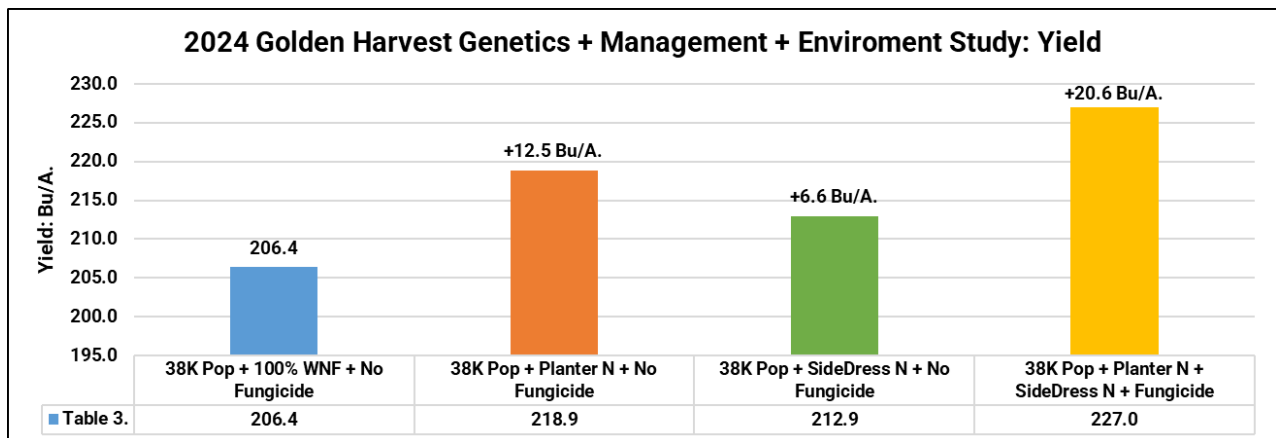

Planting Date: April 21<sup>st</sup> Hybrid: Multiple Pop: 36K Row Width: 30" Rotation: CAB Corn Price: \$4.08 SD App: \$12 Fungicide + App: \$30

## GMO/Non-GMO/Organic Corn Study

**Objective:** To evaluate the yield and economic differences of a GMO, non-GMO, and an organic corn management program.

This trial focuses on introducing organic and non-GMO farming practices at the PTI Farm. If there is a current or future market for organic or non-GMO corn and buyers are willing to pay farmers a premium for it, we feel it prudent to challenge the status quo of conventional farming practices. This is the second organic transition year at the PTI Farm.

Below are the parameters on how each management system will be evaluated for yield and cost:

### **Programs/Treatments:**

#### **GMO Program:**

Tillage:	Fall Disk Ripper/Spring Soil Finisher
Dry Fertilizer Fall Applied:	200# 18-46-0, 200# 0-0-60
225# Nitrogen:	25% Weed-N-Feed, 25% Conceal®, 50% SideDress
Herbicide:	2 pass Acuron® Flexi/Atrazine/Roundup
GMO Trated Seed:	Pioneer 1742Q
Fungicide:	VT Miravis®Neo Fungicide

#### **Non-GMO Program:**

Tillage:	Fall Disk Ripper/Spring Soil Finisher
Dry Fertilizer Fall Applied:	200# 18-46-0, 200# 0-0-60
225# Nitrogen:	25% Weed-N-Feed, 25% Conceal®, 50% SideDress
Conventional Herbicide:	2 pass Acuron® Flexi/Atrazine
Row Crop Cultivation:	2 Pass Garford RoboCrop Guided Row Cultivation
Non-GMO Seed:	Prairie Hybrids 8864
Fungicide:	VT Miravis®Neo Fungicide

## GMO/Non-GMO/Organic Corn Study

\*All products organic certified

### Organic Program:

Tillage:	Fall Disk Ripper/Spring Soil Finisher
Dry Product:	250# Phinite® Organic Fertilizer (3-12-0)
Dry Product:	150# Sea-90 Dehydrated Sea-Water/Sodium Cl.
Manure:	2 Ton Fall Applied Chicken Litter
Organic Seed:	Prairie Hybrids 7461
Seed Treatment:	KelpakMaxx, Prime Pro-M Biological
FurrowJet 3-Way:	7 Gal/A. TripleThreatOption Biological Extract, Kelpak, MicroMix
Conceal® Dual Band: (Fig. 1)	7 Gal/A. TripleThreatOption + Biological Extract 20 Gal Green Lightning PAW
Row Crop Cultivation:	2 Pass Garford vision system row crop cultivation
V3 SideDress:	NPlace Max 250# Phinite® 3-12-0, 15 Gal/A. PAW
V4 Foliar:	2 Qts/A. K-Ferm 0-0-12, 2 Gal/A. TerraFed, Kelpak, 20 Gal/A. Green Lightning PAW
V6 EZ-Drop SideDress:	7 Gal/A. TripleThreatOption + Biological Extract, 2# Sodium Borate
V10:	30 Gal/A. Green Lightning PAW, 1 Gal Sea-90
VT Foliar:	2 Qts/A. K-Ferm 0-0-12, 2 Gal/A. TerraFed, 1 Pt/A. Kelpak + MicroMix, 20 Gal Green Lightning PAW



NON-GMO | ORGANIC



## GMO/Non-GMO/Organic Corn Study

Figure 1. PTI Research Planter



Figure 2. Conceal® Dual Band Placement



Figure 3. Chicken Litter Application



Figure 4. Garford Row Crop Cultivator



Figure 5. Miller N-Place™ Max



Figure 6. Ez-Drops™



## GMO/Non-GMO/Organic Corn Study

**Results:** The organic program proved overall yield losses of **-33.8 Bu/A**, compared to a status quo traditional commercial program. Seeing these yield losses may cause some hesitation for organic corn, however the true story lies in overall economics of the programs. Using a \$6.08/Bu. sale price (\$2/Bu premium), organic corn offered a positive return on investment of +\$80.51/A. over the conventional program. Being new to organic farming, we look forward to understanding and improving weed control and nutrition management practices.

The non-GMO platform resulted in yield losses of **-10.2 Bu/A.**, however with a \$0.25/Bu/A. premium with its agronomic protocol resulted in the largest economic gains of the study at +\$87.68/A. The only real management change with the non-GMO program was herbicide and seed. With herbicide, all glyphosate was removed from the program, while the same residual and post program was the same for the GMO program. Also, seed cost for non-GMO seed was significantly less than GMO.

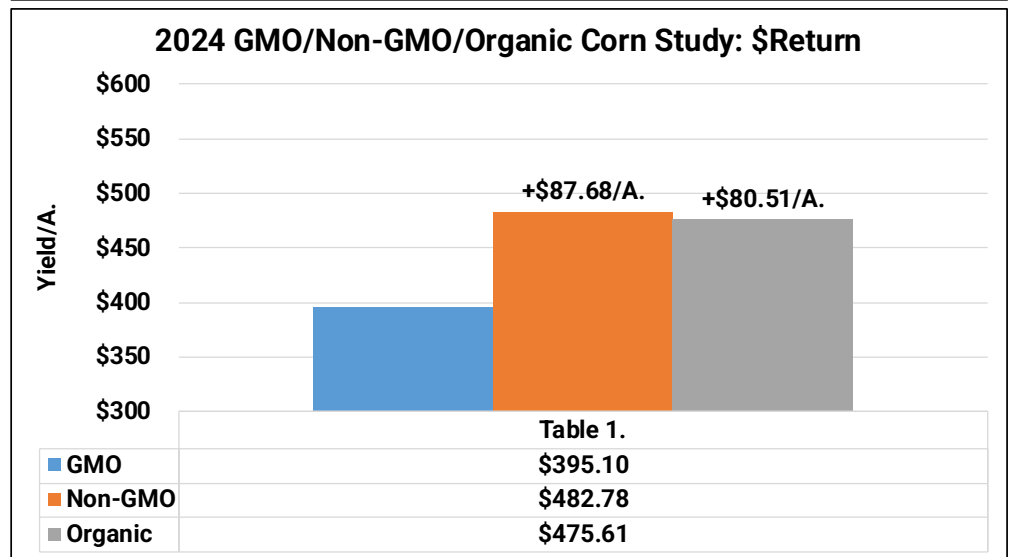
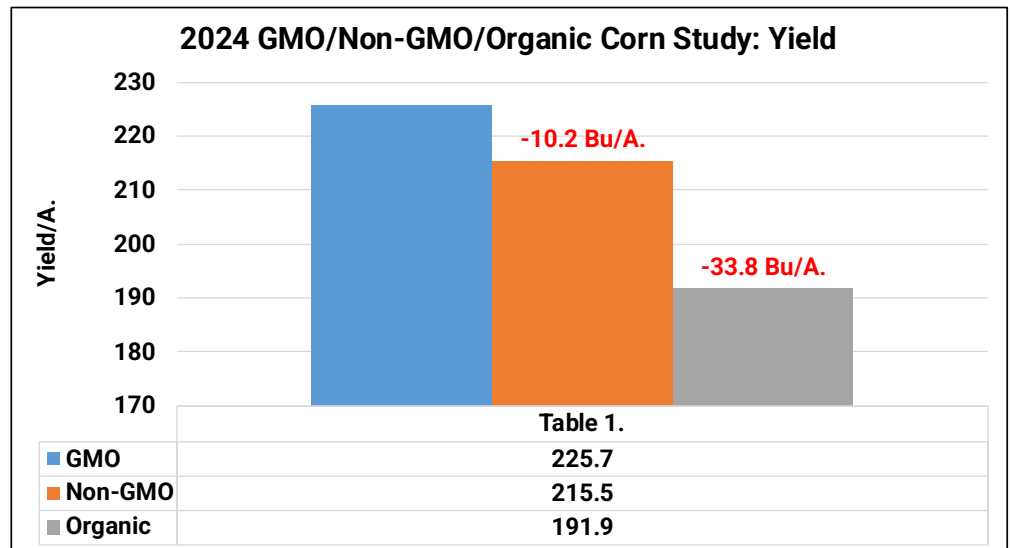

Planting Date: May 15<sup>th</sup>    Population: 36K    Row Width: 30"    Rotation: CAB    Corn Price: \$4.08/\$6.08    Non-GMO Premium: \$0.25/Bu

Conventional Program: \$525.76/A.    Non-GMO Program: \$450.34    Organic Program: \$691.14/A

## Marco QuickGrow LTE FurrowJet® Study

**Objective:** To evaluate the yield and net return of Marco Fertilizer’s QuickGrow LTE 6-20-4-.25Zn-2.7S liquid starter fertilizer at rates of 4, 6 and 8 Gal/A. applied in an at-plant 3-way FurrowJet® system. QuickGrow LTE is a 70% polyphosphate and 30% orthophosphate formulation of nitrogen, phosphorus, potassium, sulfur, and 9% Zn.

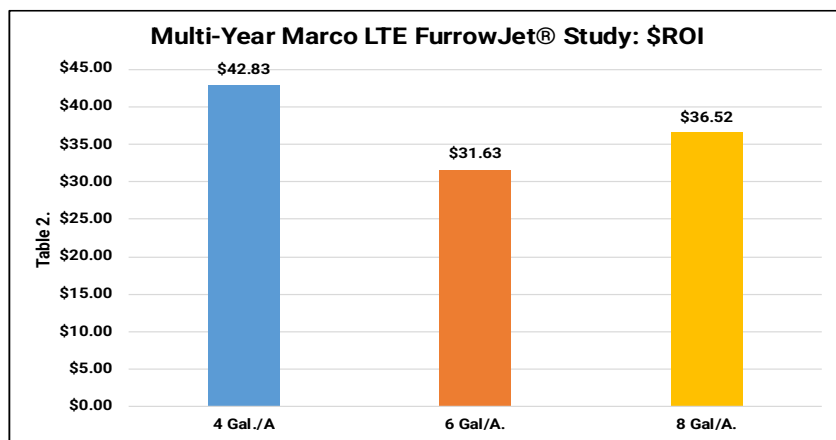
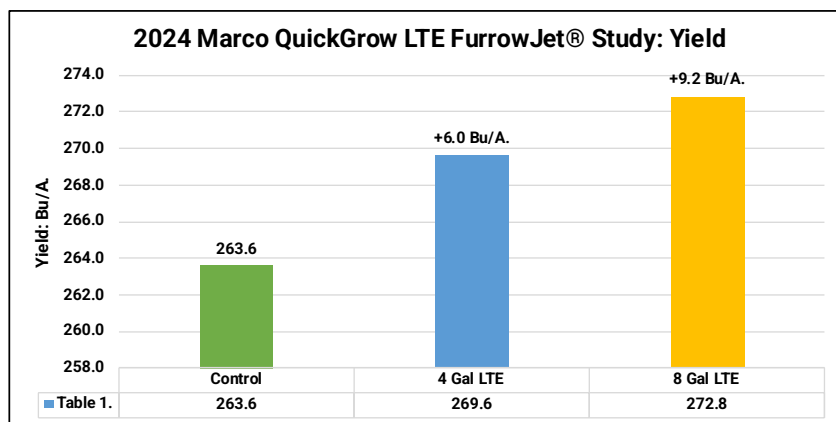

Figure 1. FurrowJet® Placement



**Results:** Table 1. illustrates all rates of Marco QuickGrow LTE resulted in positive yield gains. However, 8 Gal/A. rates achieved agronomic optimum rate, with yield gains of +9.2 Bu/A. and net returns of +\$30.74/A. The 4 Gal/A. rate proved yield gains of +6.0 Bu/A., with corresponding return on investment of +\$36.08/A.

Table 2. summarizes multi-year data, indicating 4 Gal/A. being economic optimum rate over the 2019 to 2024 time-period. All applications are implemented with a \$30/A. reallocation.



## NACHURS® imPulse® FurrowJet® Center Placement Trial

**Objective:** To evaluate the effect on yield and economics when NACHURS imPulse® 10-18-4 starter fertilizer (Figure 2.) is placed at 5 to 7 Gal/A. in FurrowJet® **center** only configurations (Figure 1). NACHURS imPulse® is a premium 100% orthophosphate in-furrow liquid fertilizer that contains NACHURS bio-K® technology.

Figure 1. FurrowJet® Placement

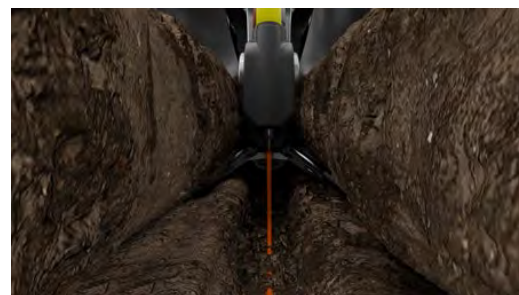
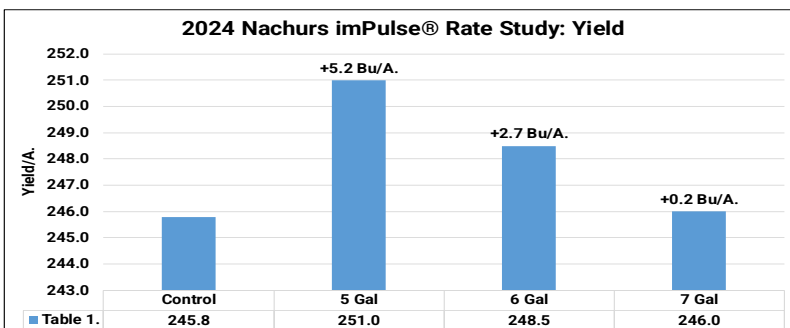
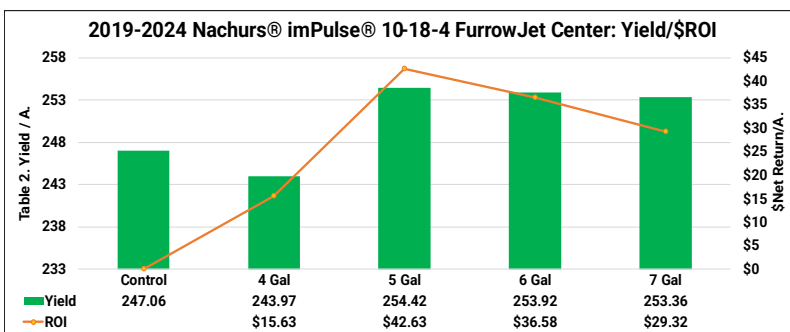

Figure 2. Nachurs imPulse® Starter



### 10-18-4 Liquid Fertilizer

#### Nutrients Supplied (pounds per gallon)

Total Nitrogen (N)	1.06
Available Phosphate (P <sub>2</sub> O <sub>5</sub> )	1.91
Soluble Potash (K <sub>2</sub> O)	0.42

**Derived from:** ammonium hydroxide, urea, phosphoric acid, potassium acetate, and potassium hydroxide.

**Results:** Table 1. illustrate rates of Nachurs imPulse® 10-18-4 at 5 Gal/A. achieved agronomic optimum rate with yield gains of +5.2 Bu/A. along with positive net returns of +\$27.72/A.

Table 2. illustrates multi-year data over 2019-2024 indicating the 5 Gal/A. rate as economic and agronomic optimum over this time period, with an average return on investment of +\$42.63/A.

## Pivot Bio PROVEN®40 In-Furrow Nitrogen Mgt. Study

**Objective:** To evaluate the effect on yield and economics using Pivot Bio’s PROVEN®40, a nitrogen-producing microbe for corn. These microbes create a symbiotic relationship with the corn plant, producing nitrogen and delivering it directly to the roots of the corn plant.

Microbes then continually feed nitrogen to the corn plant throughout the growing season.

Pivot Bio PROVEN®40 microbes adhere to the roots of the corn plant and support a reliable and consistent method for delivering plant nutrition. For this agronomic study, nitrogen rate is evaluated at 100% full rates (225#N) as well as -18% N reductions (185# total N or 40# N reduction). Pivot Bio PROVEN®40 was applied in-furrow at planting via FurrowJet® treatments (Figure 1).



Figure 1. FurrowJet® At-Plant



**Results:** Table 1. illustrates the control in the study being 100% nitrogen rates (225#N), offering base yields of 293.7 Bu/A. Reducing nitrogen by 40# (or 18%) resulted in losses of **-16.8 Bu/A.** However, when PROVEN®40 was added to that same nitrogen reduction rate of 185#N, yields were with-in 1.4 Bu/A. than the control rate of 225# N/A. Table 2. reveals the economics of the PROVEN®40 system. Stand-alone -40# nitrogen reductions resulted in economic losses of **-\$44.96/A.** PROVEN®40 applied via FurrowJet®, along with -40# N reductions, resulted in an economic loss of **-\$1.90/A.** over the standard 225# N control rate.

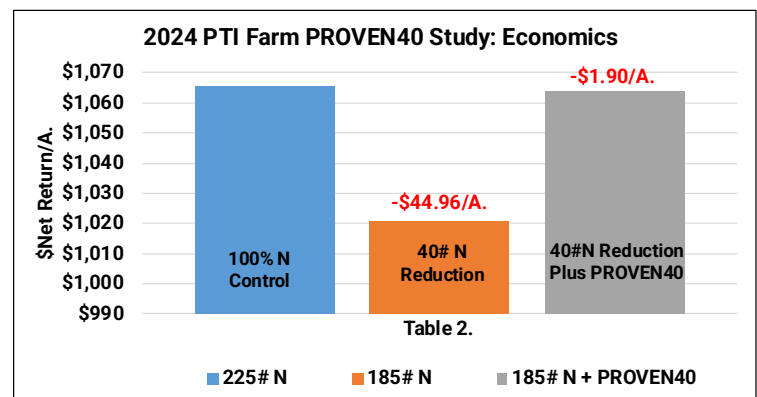
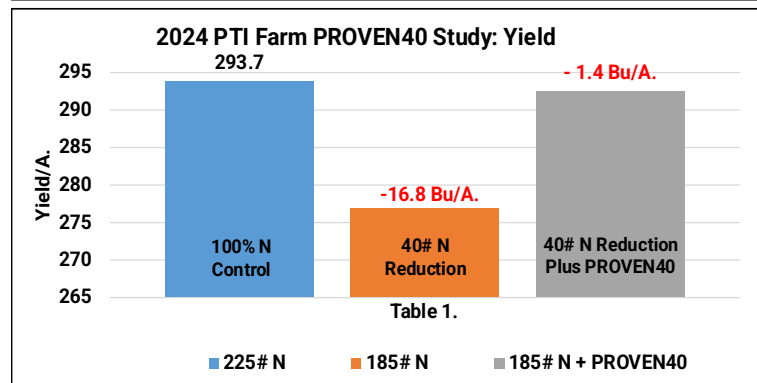

## Pivot Bio PROVEN®40 In-Furrow Nitrogen Mgt. Study Continued

Tables 3-4. illustrate the five year data set summary of Pivot Bio PROVEN®40 over the years of 2020-2024. In this timeframe, reducing nitrogen rate by 40#N, along with the addition of PROVEN®40 applied via FurrowJet® has resulted in yield losses of **-1.2 Bu/A.**, however due to the 40# nitrogen reduction and lower input cost, generated an additional **+\$1.69/A.** of farm income.

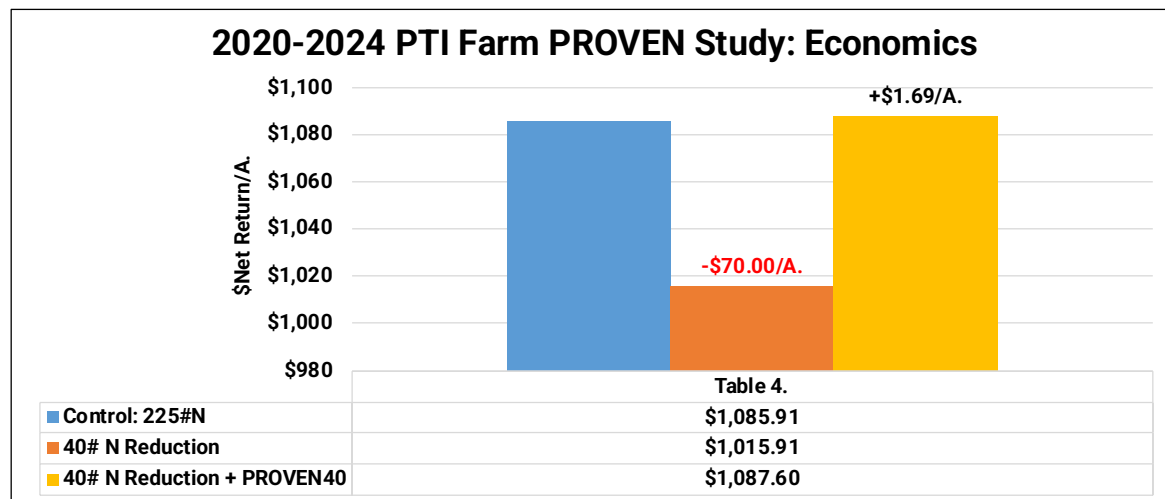
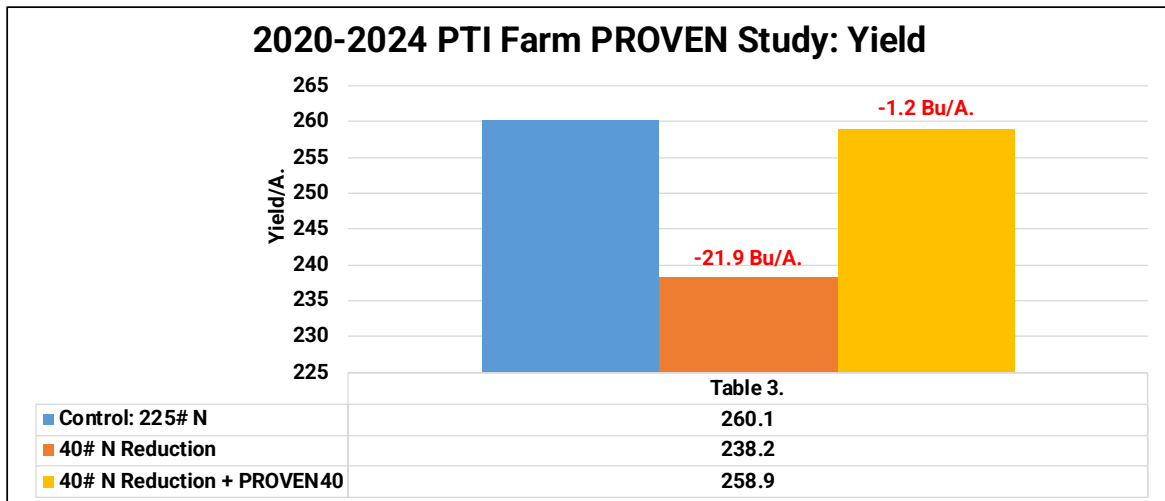

Planting Date: May 10<sup>th</sup> Hybrid: Pioneer 1742Q Population: 36.5K Row Width: 30" Rotation: CAC Corn Price: \$4.08 UAN 32%: \$0.59/# PROVEN®40: \$20/A.

## Pivot Bio PROVEN®40 On-Seed Nitrogen Mgt. Study

**Objective:** To evaluate the effect on yield and economics using Pivot Bio’s PROVEN®40 OS, an on-seed treatment of PROVEN®40, a nitrogen-producing microbe for corn. These microbes create a symbiotic relationship with the corn plant, producing nitrogen and delivering it directly to the roots of the corn plant. Microbes then continually feed nitrogen to the corn plant throughout the growing season. Pivot Bio PROVEN®40 microbes adhere to the roots of the corn plant and support a reliable and consistent method for delivering plant nutrition.



For this continuous corn agronomic study, nitrogen rate is evaluated at 100% full rates (225#N) as well as -40# N reductions (185# Total), with and without PROVEN®40 OS seed treatments.

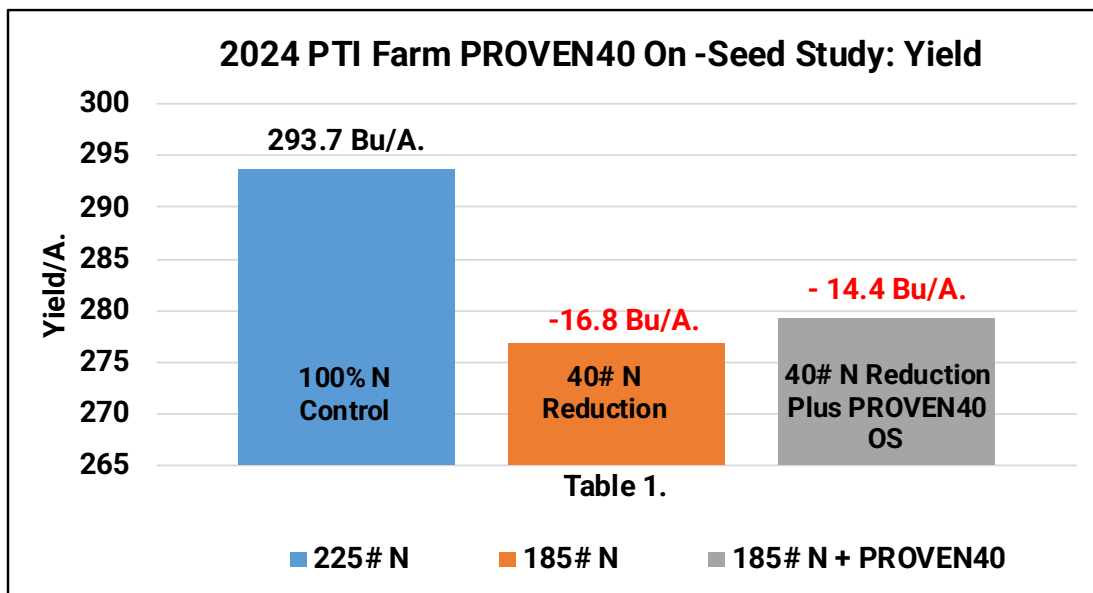

## Pivot Bio PROVEN®40 On-Seed Nitrogen Mgt. Study Continued

**Results:** Tables 1-2. Illustrate that 100% full rates of nitrogen provided highest yields in this study. Reductions of 40# of nitrogen resulted in overall yield losses of **-16.8 Bu/A.**, with corresponding economic losses of **-\$44.96/A.** PROVEN®40 OS seed treatments with -40# N reduction, resulted in yield losses of **-14.4 Bu/A.** with economic losses of **-\$55.01/A.**

The big advantage of a seed treatment product is the ability to eliminate tanks, pumps, and other associated equipment on the planter that reduces cost and favors convenience.

However, Table 3. illustrates the multi-year (2023-2024) differences in performance of the seed treated PROVEN40®, applications compared to that of liquid in-furrow applied via FurrowJets. On-Seed treatments of PROVEN40 posted economic losses of **-\$68.70/A.**, while in-furrow posted only **-\$6.32/A.** losses.

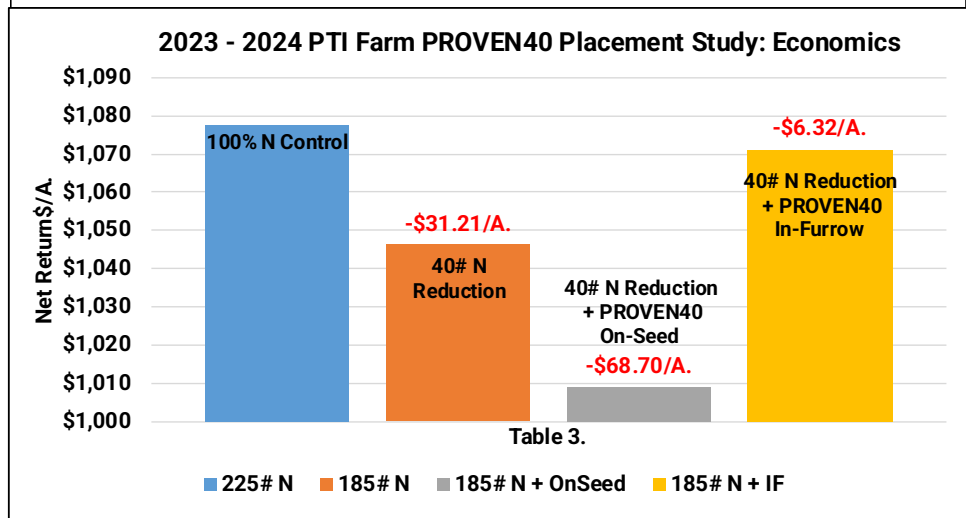
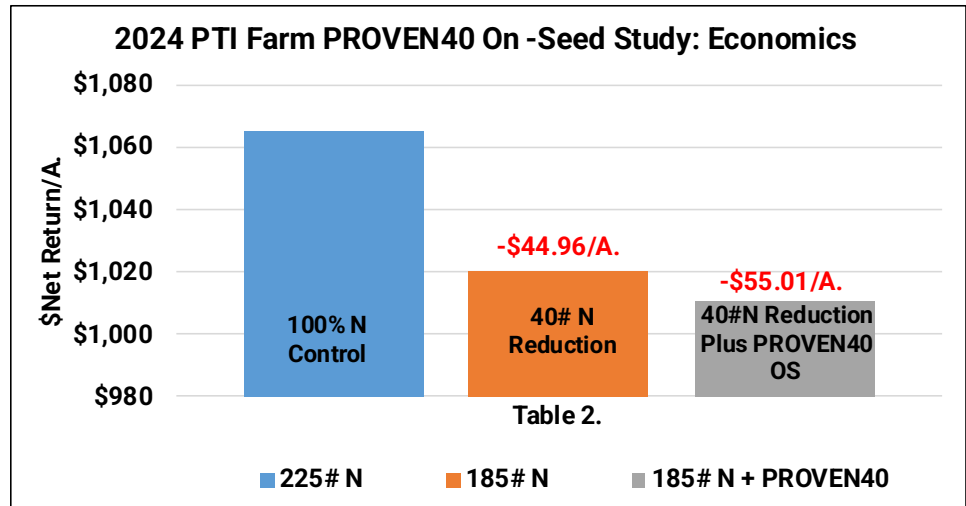

## Envita® Nitrogen Mgt. Study

**Objective:** To evaluate yield and economics of Envita®, applied in-furrow at planting in a FurrowJet® center only application (Figure 1), at 100% and 90% nitrogen rates, and a foliar V3 application.

Envita®, distributed by NewFields Ag™, is a naturally occurring, food-grade bacteria - *Gluconacetobacter diazotrophicus*, that was originally discovered in sugarcane. Envita® forms a symbiotic relationship with the host plant and provides nitrogen to cells throughout the plant, both above and below ground, all season long. The use of fertilizers and particularly nitrogen fertilizer is necessary for crop yield and quality. Soybeans and other legume crops have a natural ability to fix nitrogen through their root system, a process supported by rhizobia, which allows inoculated plants to create nodules that fix additional nitrogen in the soil. This practice is commonplace in soybean, but until now there has not been a similar solution for non-legume crops – now there is.



Figure 1: FurrowJet® In-Furrow Application



**Results:** Table 1. illustrates yield gains of +6.6 Bu/A. when Envita® was applied in-furrow along with a standard 100% nitrogen rate. When nitrogen rate was reduced by 10% (202.5#N), yield decreased by **-5.3 Bu/A.**, however it posted +1.3 Bu/A. better yield than the control.

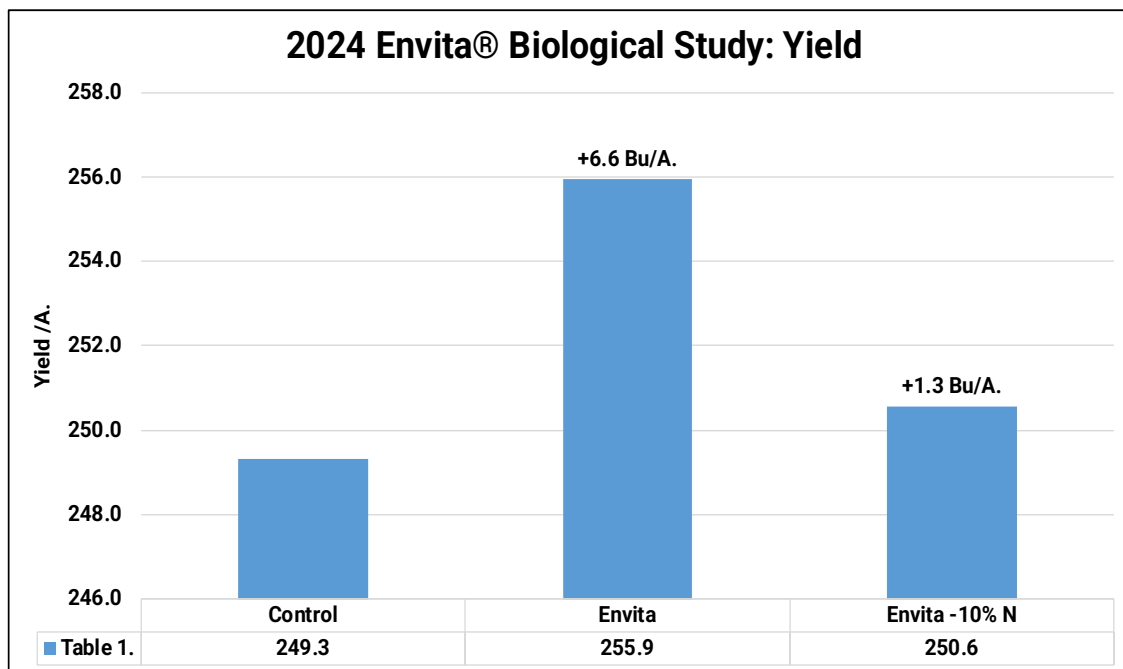

## Envita® Nitrogen Mgt. Study Continued

Table 2. illustrates economic gains of +\$12.03/A. when Envita® was applied in-furrow along with a standard 100% nitrogen rate. When nitrogen rate was reduced by 10% in conjunction with Envita®, economic gains resulted in +\$3.40/A., a net loss of **+\$8.63/A.**

Table 3. depicts a 3-year economic summary with Envita® in-furrow applications resulting in gains of +\$31.71/A., while Envita® with 10% nitrogen reductions with gains of+\$18.16/A.

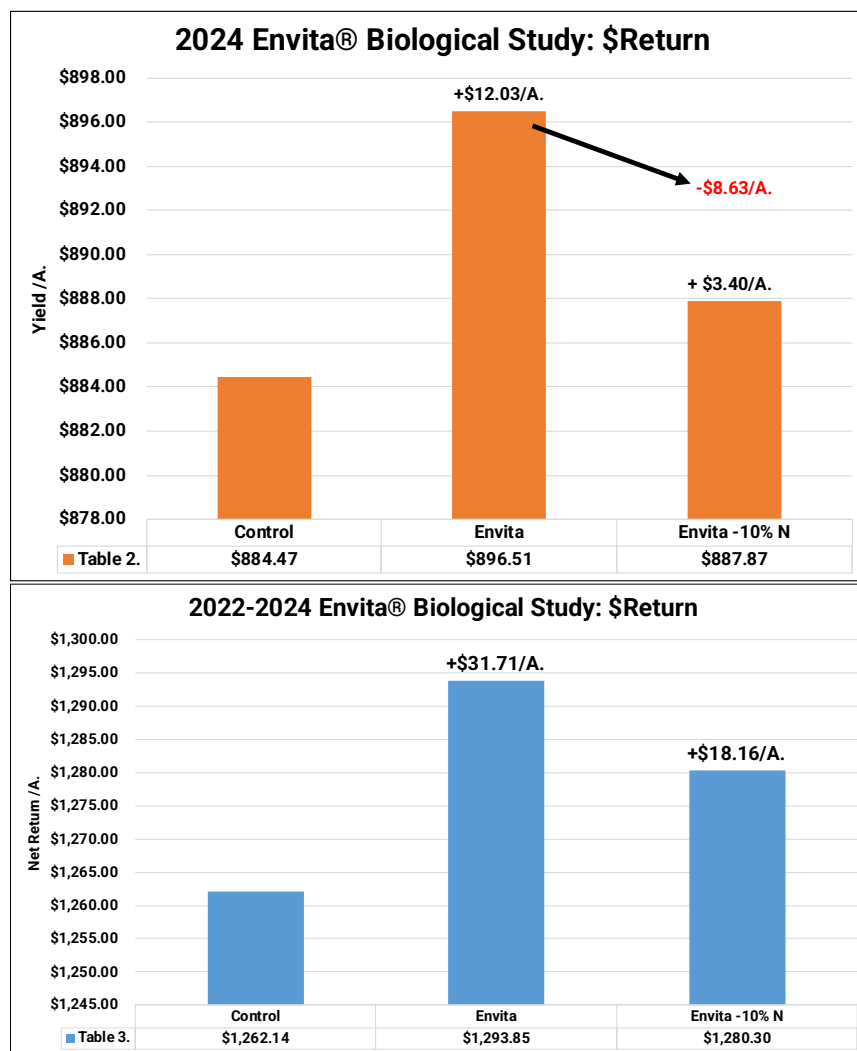

Planting Date: May 10<sup>th</sup> Hybrid: DeKalb 64-22 Population: 36.5K Row Width: 30" Rotation: CAC Corn Price: \$4.08 Envita: \$14.95/A.

## NanoCOTE™ Urea Treatment Study

**Objective:** To evaluate yield and economics of NanoCOTE™, a patented nanoparticle technology that improves the delivery of macro and micronutrients in dry fertilizers through a unique and flexible coating technology. NanoCOTE™ products utilize multiple mechanisms to improve the overall uptake of nutrients. The core technology is built around a flexible biodegradable copolymer which disperses nutrients and is infused with nanoparticles designed to increase plant nutrient uptake.

50# actual pounds of nitrogen was applied with urea (46-0-0) and side-dresses in a 6" wide band with a Miller N-Place™ Max side-dress applicator (Figure 1).

Urea was treated with NanoCOTE to help improve the delivery and plant uptake of nitrogen.

Urea was banded via a dry tank and blower system that accurately places urea prills near the base of the corn plant. Work is being done with the toolbar to incorporate or cover the urea prills with soil to protect against volatilization.

Advanced flow and blockage visibility was implemented by pairing Clarity™ with the 20|20 monitoring system.

Figure 1: Miller N-Place™ Max Side-Dress Toolbar



### High-Definition Visibility With the 20|20

The Clarity system displays and maps blockage variability and product blockage metrics, row-by-row, on the 20|20 monitor in the cab. Instead of just red or green lights, you'll see numbers and statistics tied to the performance of the product delivery system, giving you more accuracy than standard systems on the market.





## NanoCOTE™ Urea Treatment Study

**Results:** Table 1. illustrates yield gains of +5.2 Bu/A. when NanoCOTE™ was applied to side-dress urea nitrogen.

These yield gains corresponded to a positive return on investment of +\$17.14/A. (Table 2.)

Figure 2: Banded Urea on V6 Corn

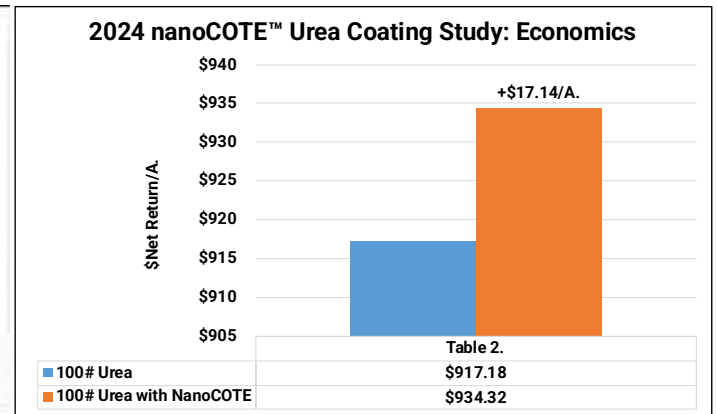
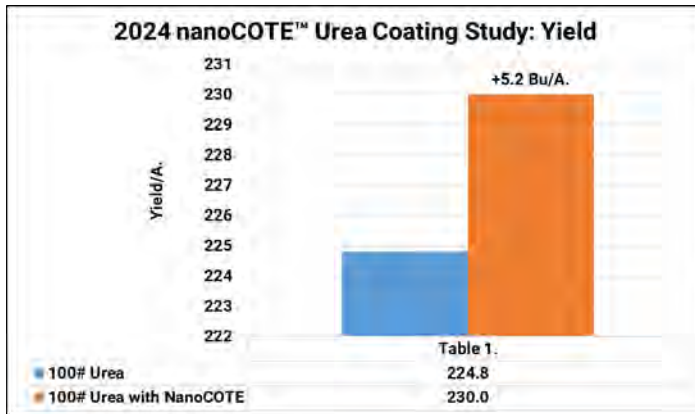

Planting Date: May 19<sup>th</sup>    Hybrid: DeKalb 66-06    Population: 36.5K    Row Width: 30"    Rotation: CAB    Corn Price: \$4.08    NanoCote: \$3.75/A.

## **SIMPAS® Soil Insecticide/Seed Trait Study**

**Objective:** To evaluate the yield and economics of applying at-plant soil insecticides, in addition to using corn hybrids with SmartStax® traits.

For this study, three insecticides were applied using a SIMPAS® in-furrow closed delivery system, in conjunction with Smart Cartridges.

Counter20G is an organophosphate granular insecticide containing Terbufos, that provides control of western and northern corn rootworm larvae, as well as a nematicide that controls lance, lesion, root knot, spiral, stunt, sting, stubby root, and dagger nematodes. Counter 20G is unique in that it features systemic activity that controls insects below ground as well as insects in or on the corn plant during early season growth.



Force® 10G HL corn soil insecticide containing Tefluthrin, provides proven, broad-spectrum control of listed corn rootworm larvae and seed- and seedling-attacking pests, with a reliable pyrethroid mode of action and the highest concentration of any Force granule.



AZTEC® HC corn soil insecticide containing Tebupirimphos and Cyfluthrin, provides consistent, broad-spectrum control of corn rootworm larvae (CRW) as well as seed- and seedling-attacking pests, like wireworm, for strong stands and maximum yields regardless of corn hybrid selection.



VT Double PRO® corn contains dual modes of action for protection against above-ground pests, like European and Southwestern corn borers, fall armyworm, and corn earworm.

SmartStax traited seed controls a broad spectrum of pests which includes larvae of above-ground insects such as European corn borer, black cutworm, southwestern corn borer, corn earworm, fall armyworm, western bean cutworm, and below-ground feeding larvae of western corn rootworm and northern corn rootworm.



**VT Double PRO®**

**SmartStax®**

## **SIMPAS® Soil Insecticide/Seed Trait Study**

**Results:** Table 1. illustrates soil insecticide treatments, on average resulted in yield gains of only +0.7 Bu/A. in addition to the SmartStax® trait. The same hybrid, but with a VT Double Pro® trait platform (non-rootworm) resulted in similar yield to the SmartStax® trait, but with an actual gain of +0.3 Bu/A.

Applying insecticide in addition to traited corn, proved yield gain, however, not enough to achieve positive economic return. Table 2. tells the economic story with soil applied applications resulting in economic losses of **-\$10.60/A.** In 2024, the presence of corn rootworm feeding was very low. This low pressure, combined with higher seed/trait prices, resulted in VT Double Pro with highest return on investment of +\$23.33/A.

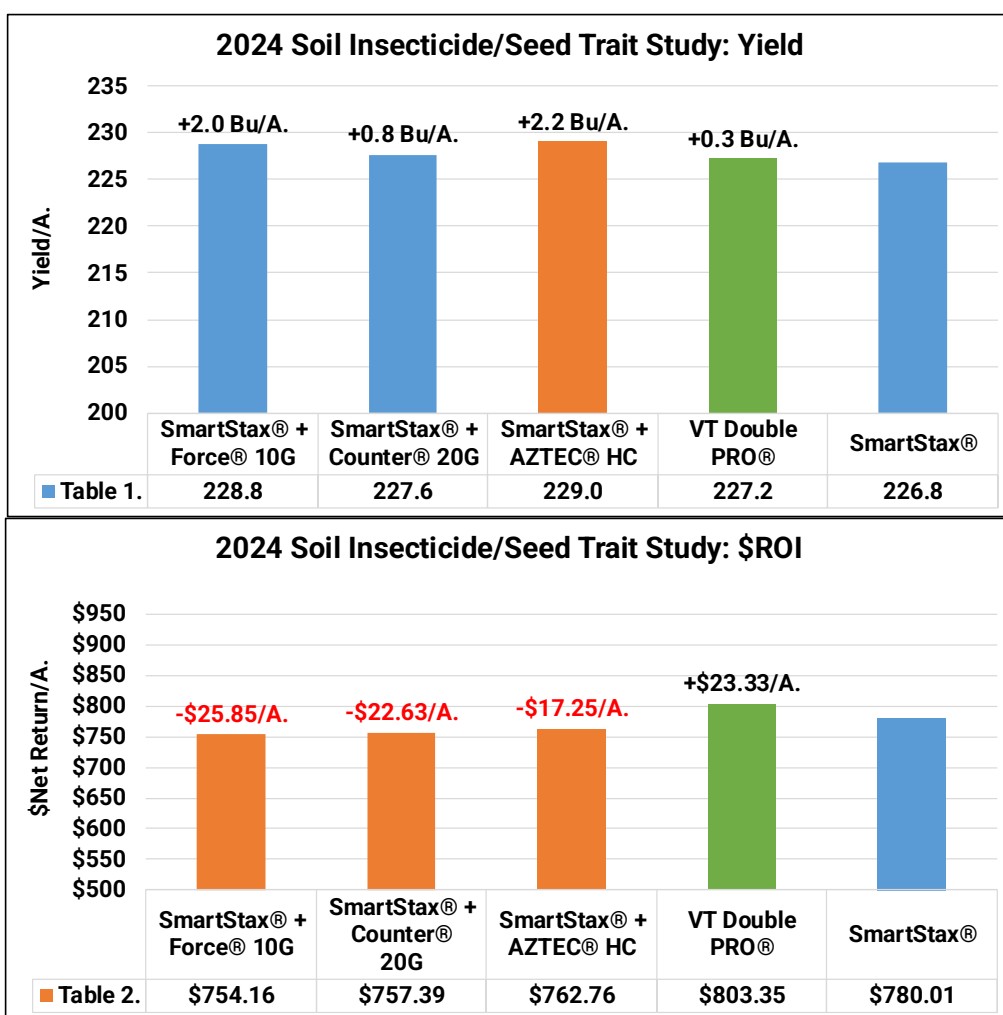

Planting Date: May 19<sup>th</sup> Hybrid: Wyffels7878SS (\$323.15/Bag), 7876VT2P (\$274.30/Bag) Population: 36K Row Width: 3\$26.21/A.0"

Tillage: Strip-Till Rotation: CAC Corn Price: \$4.08 Counter20G: \$25.96/A. Force 10G: \$33.80/A. Aztec HC: \$26.21/A.

## **Nurizma™ Soil Insecticide/Seed Trait Study**

**Objective:** To evaluate the yield and economics of applying Nurizma™ at planting, in addition to planting a corn hybrid with SmartStax® traits.

Nurizma™ insecticide from BASF, is an in-furrow insecticide product with a unique mode of action that protects against common belowground pests, including corn rootworm larvae, wireworms, white grubs and seed corn maggots at the source: the roots. Nurizma™ insecticide's active ingredient, broflanilide is the first group 30 active ingredient registered and sold as an in-furrow insecticide. This IRAC Group 30 insecticide controls belowground pests to help protect your yield potential and harvest efficiency.

VT Double PRO® corn contains dual modes of action for protection against above-ground pests, like European and Southwestern corn borers, fall armyworm, and corn earworm.

SmartStax traited seed controls a broad spectrum of pests which includes larvae of above-ground insects such as European corn borer, black cutworm, southwestern corn borer, corn earworm, fall armyworm, western bean cutworm, and below-ground feeding larvae of western corn rootworm and northern corn rootworm.

Figure 1: FurrowJet® In-Furrow Application



# Nurizma™



## Nurizma™ Soil Insecticide/Seed Trait Study

**Results:** Table 1. illustrates planter applied treatments of Nurizma resulted in yield gains of +4.2 Bu/A. in addition to the SmartStax® trait. The same hybrid , but with a VT Double Pro® trait platform (non-rootworm) resulted in similar yield to the SmartStax® trait, but with an actual gain of +0.3 Bu/A.

Applying Nurizma insecticide in addition to traited corn, proved yield gain, however, not enough to achieve positive economic return. Table 2.. tells the economic story with Nurizma applications resulting in economic losses of **-\$8.37/A.** In 2024, the presence of corn rootworm feeding was very low. This low pressure, combined with higher seed/trait prices, resulted in VT Double Pro with highest returns of +\$23.33/A.

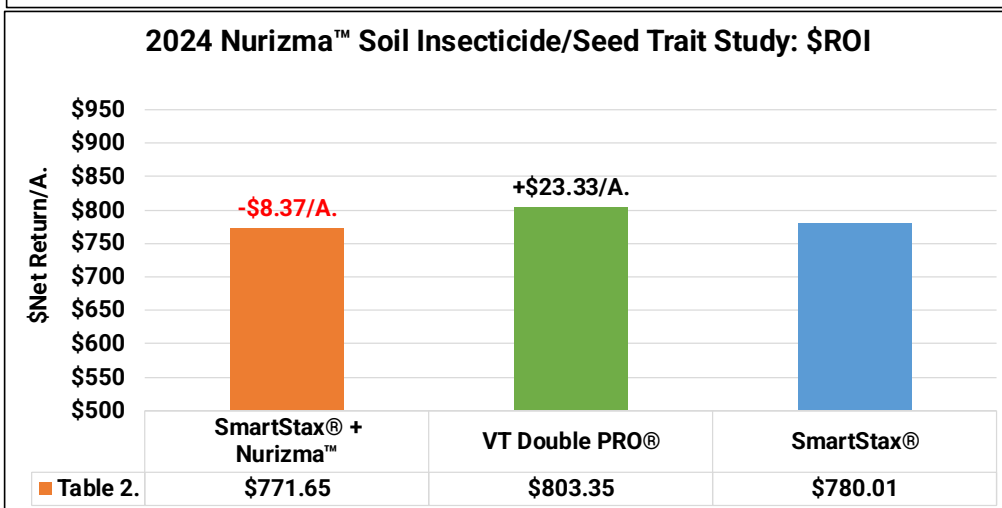
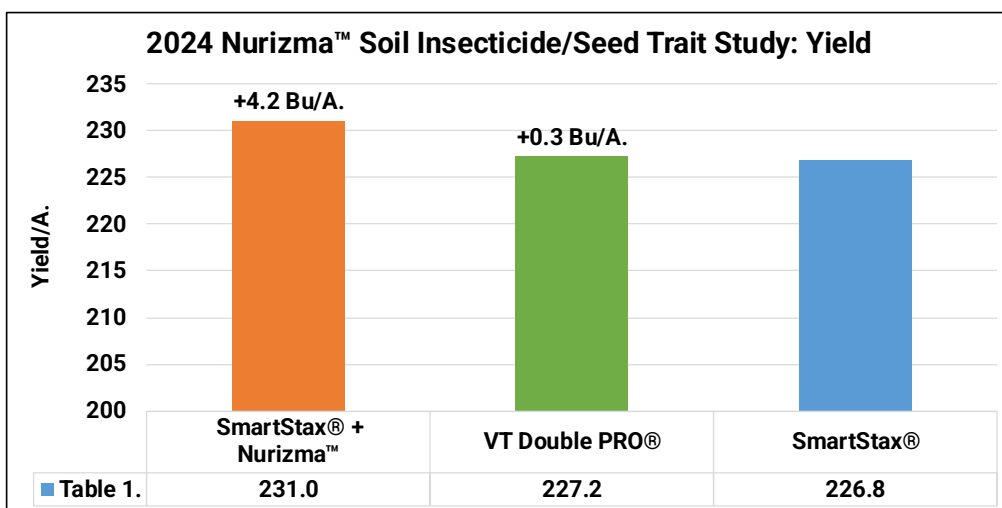

Planting Date: May 19<sup>th</sup> Hybrid: Wyffels7878SS (\$323.15/Bag), 7876VT2P (\$274.30/Bag) Population: 36K Row Width: 30"

Tillage: Strip-Till Rotation: CAC Corn Price: \$4.08 Nurizma: \$25.40/A

## Nurizma™ Soil Applied Insecticide Study

**Objective:** To evaluate yield and economics of Nurizma™, applied in-furrow at planting in a FurrowJet® center only application (Figure 1.), at 1 fl/oz/A. rate using VT Double PRO™ non-rootworm traited corn.

Nurizma™ insecticide from BASF, is an in-furrow insecticide product with a unique mode of action that protects against common belowground pests, including corn rootworm larvae, wireworms, white grubs and seed corn maggots at the source: the roots.

Nurizma™ insecticide’s active ingredient, broflanilide is the first group 30 active ingredient registered and sold as an in-furrow insecticide. This IRAC Group 30 insecticide controls belowground pests to help protect your yield potential and harvest efficiency.

Figure 1: FurrowJet® In-Furrow Application



**Results:** Table 1. illustrates yield gains of +7.8 Bu/A. when Nurizma™ was applied in-furrow at a 1oz rate. After a product cost of \$25.40/A., Nurizma™ proved economic gains of +\$6.42/A.

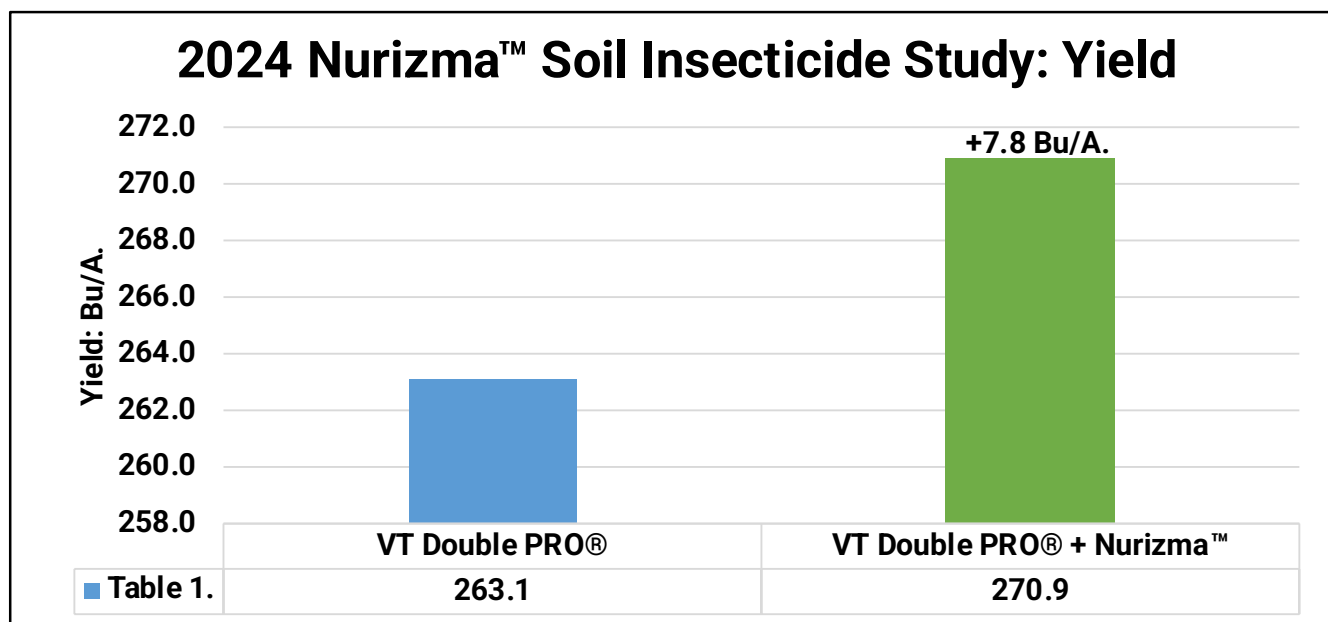

*Planting Date: May 10<sup>th</sup> Hybrid: Wyffels 8086VT2P (\$274.30/Bag) Population: 36K Row Width: 30" Rotation: CAB Corn Price: \$4.08 Nurizma™: \$25.40/A.*

## PLINAZOLIN® Technology SC300

**Objective:** To evaluate yield and economics of Plinazolin technology SC300, applied in-furrow at planting in a FurrowJet® center only application (Figure 1), at 5.25 fl/oz/A. rate.

Figure 1: FurrowJet® In-Furrow Application



PLINAZOLIN® technology from Syngenta features a novel mode of action and is the trademark of a new active ingredient that protects plant health with outstanding performance on a wide range of harmful pests that affect key crops., PLINAZOLIN technology will deliver unprecedented insect control on stinkbugs, mites, thrips, caterpillars, flies, and beetles. It will be commercialized in more than 40 countries and in over 40 crops, including soybean and corn, however, is not approved in North America. Growers in Argentina will be the first in the world to access this modern tool, following regulatory approvals, that replaces older chemistries.

**Results:** Table 1. illustrates yield gains of +12.4 Bu/A. when Plinazolin was applied in-furrow at a 1oz rate. Economics are not available, due to the product not being labeled at publishing date.

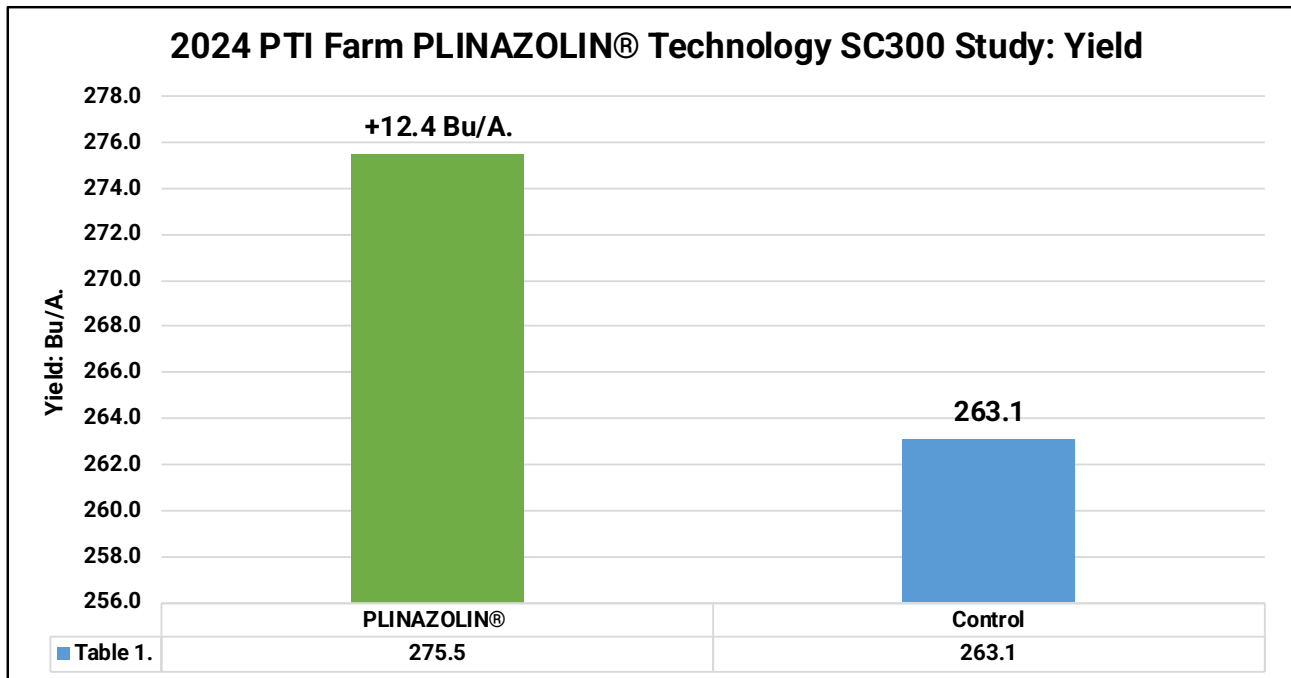

Planting Date: May 10<sup>th</sup>    Hybrid: Wyffels 7878SS    Population: 36K    Row Width: 30"    Rotation: BAC    Corn Price: \$4.08    PLINAZOLIN: NA

## Green Lightning™ Plasma Activated Water In-Furrow Study

**Objective:** To evaluate yield, net return, and nitrogen use efficiency (NUE) of Green Lightning plasma activated water. Green Lightning is a mechanism to replicate a naturally occurring process that leads to nitrogen. During a lightning storm, static electricity rearranges the nitrogen molecule in the air, and this modified molecule is contained within the rain. Green Lightning devices create lightning in a controlled environment under the same premise. Air and water are sent into a static electric field for the nitrogen molecule to go through a rearrangement process that allows attachment of the water present, flowing through the machine, and deposits an end product as NO<sub>2</sub> (nitrite) and NO<sub>3</sub> (nitrate).

A six head system called the THUNDER 365, produces nitrogen for 550 acres of corn annually. This system is designed for use by a farmer, in his/her own tool-shed, to make nitrogen by using only a 110v power, grounding rods, and a water supply.

This study compares the use of Green Lightning nitrogen applied as an in-furrow treatment applied through FurrowJet®, a planter fertilizer attachment that enables placement of fertilizer on the seed as well as 3/4" on each side of the seed (Figure 2) at applied rates of 4, 6, 8, 12 and 16 Gal/A.

Figure 1. Green Lightning Plasma Activated Water Machine



Figure 2-3: FurrowJet® In-Furrow Application





## Green Lightning™ Plasma Activated Water In-Furrow Study

**Results:** The tables below illustrate no yield advantage at any application rate. 4 Gal/A. rates realized losses of **-1.3 Bu/A.** and yield deficit increased as rates climbed. 8 and 12 Gal/A. rates achieved losses of **-4.7 to -5.6 Bu/A.**, while the highest rate of 16 Gal/A. proved overall highest losses of **-10 Bu/A.**

In our 2<sup>nd</sup> year of testing with this product, performance was disappointing to say the least. As a new product, we are still trying to understand the nuances of successfully creating a consistent product. The 2024 inconsistencies may be due to hard water issues (high calcium) and reverse osmosis treated water will be needed in these circumstances.

We look forward to testing this again in 2025 and

understanding how to improve quality and performance. As an environmentally friendly product that is very affordable to produce, it could offer farmers a substantial decrease in one the highest cost farm inputs, nitrogen.

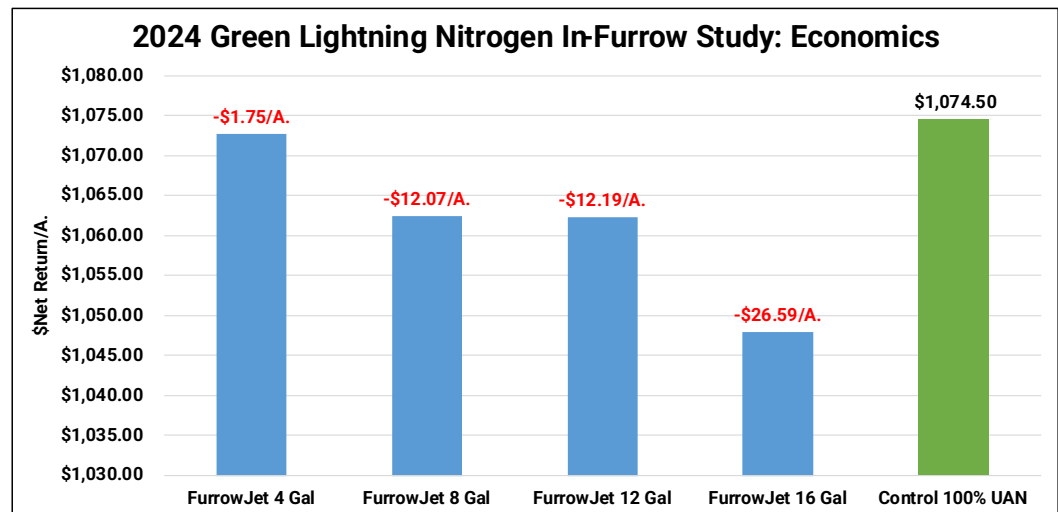
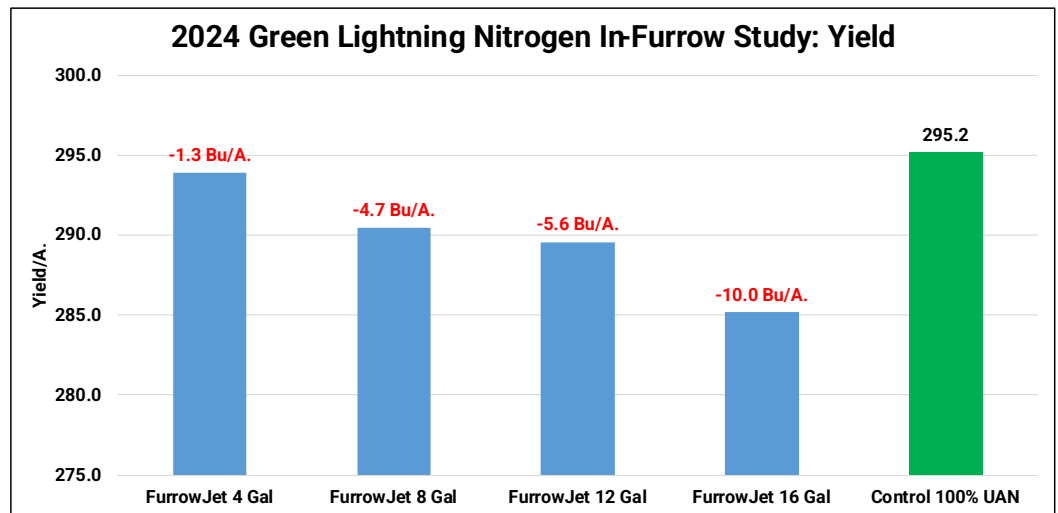

Planting Date: April 20<sup>th</sup> Hybrid: DKC 111-35VTPro Population: 36K Row Width: 30" Rotation: CAC Corn Price: \$4.08 Green N: \$0.04/Gal. N: \$0.58/#

## Green Lightning™ Plasma Activated Water Nitrogen Study

**Objective:** To evaluate yield, net return, and nitrogen use efficiency (NUE) of Green Lightning plasma activated water. Green Lightning is a mechanism to replicate a naturally occurring process that leads to nitrogen. During a lightning storm, static electricity rearranges the nitrogen molecule in the air, and this modified molecule is contained within the. Green Lightning devices create lightning in a controlled environment under the same premise. Air and water are sent into a static electric field for the nitrogen molecule to go through a rearrangement process that allows attachment of the water present, flowing through the machine, and deposits an end product as NO<sub>2</sub> (nitrite) and NO<sub>3</sub> (nitrate).

A six head system called the THUNDER 365, produces nitrogen for 550 acres of corn annually. This system is designed for use by a farmer, in his/her own tool-shed, to make nitrogen by using only a 110v power, grounding rods, and a water supply.

This study compares the use of Green Lightning nitrogen as a total replacement of commercial nitrogen. To accomplish this, 6 applications of Green Lightning were made during the growing season:

**Total Gal/A. Applied: 120 (Total Product Cost: \$4.80)**

- 10 Gal/A. In-Furrow at-plant with FurrowJet 3-Way Bands
- 30 Gal/A. Dual Band Conceal at-plant
- 40 Gal/A. V8 EZ-Drops™ SideDress
- 20 Gal/A. V10 Foliar Application
- 18 Gal/A. V13 Foliar Application
- 2 Gal/A. VT Foliar w/ Fungicide Application

Figure 1. Green Lightning Plasma Activated Water Machine



## Green Lightning™ Plasma Activated Water Nitrogen Study

**Results:** The tables below illustrate yield losses of **-44.8 Bu/A.** for the Green Lightning system. Due to the very low cost of producing the Green N and thus replacing the high cost of commercial corn, the Green N program's break-even yield loss was **-30.7 Bu/A.**, meaning the overall Green N program could yield **-30.7 Bu/A.** less than the commercial 32% UAN program and would just break-even. 2024 fell short of this goal by yielding **-14.1 Bu/A.** off that pace.

In our 2<sup>nd</sup> year of testing with this product, performance was disappointing to say the least. As with any new product, we are still trying to understand the nuances of successfully creating a consistent product. The 2024 challenges may be due to hard water issues (high calcium) and a reverse osmosis treated water system will be needed for success.

We look forward to testing this product again in 2025 and understanding how to improve quality and performance. As an environmentally friendly product that is very affordable to produce, Green Lightning plasma activated water could offer farmers a substantial decrease in one the highest cost farm inputs, nitrogen.

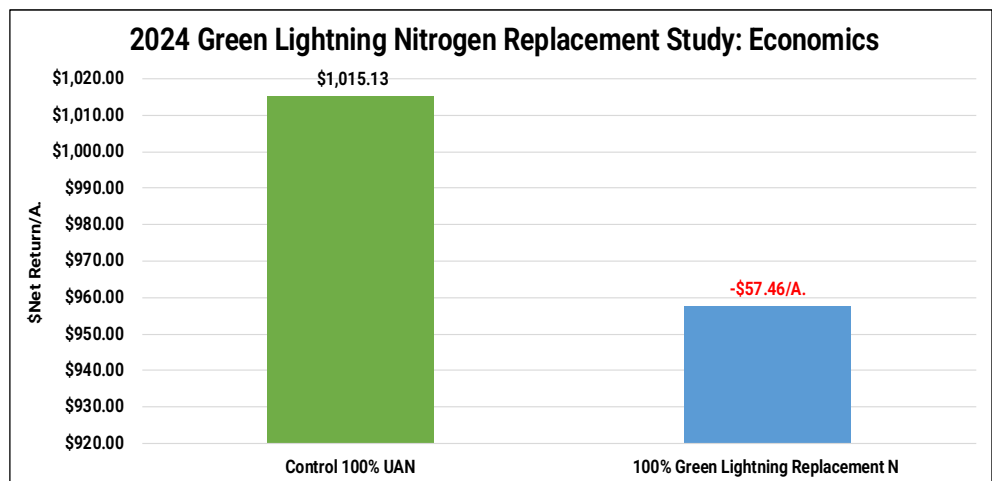
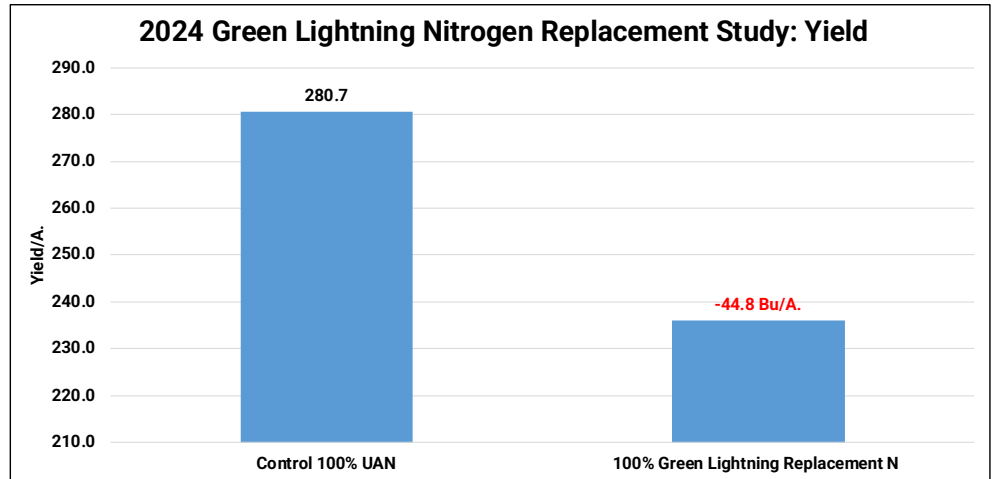

Planting Date: April 20<sup>th</sup>    Hybrid: DKC 111-35    Population: 36K    Row Width: 30"    Rotation: CAC    Corn Price: \$4.08    Green N: \$0.04/Gal.    N: \$0.58/#

## Aqua-Yield® NanoCS™ FurrowJet® Study

**Objective:** To evaluate yield and economics of NanoCS™ by AQUA-YIELD. NanoCS™ is a starter fertilizer enhancer with a robust combination of NanoShield® Technology, balanced NPK, Zinc, and Bio Stimulant. Aqua-Yield products contain nanoparticles that penetrate cell walls and creates a nano-sized shield around nutrient/molecules/ions. This technology delivers essential nutrients into the seed for rapid germination and growth.

This trial aims to establish the efficiency of Aqua-Yield’s NanoCS™ nano-liquid based fertility product in tandem with Marco QuickGrow LTE (6-20-4-2.75S-2.75Zn) in-furrow starter fertilizer. Performance of a 50% rate reduction (4Gal/A.) of LTE is then compared to the 100% rate (8 Gal/A). NanoCS™ was applied in-furrow at planting in a FurrowJet® center only application (Figure 1).



Figure 1: FurrowJet® In-Furrow Application

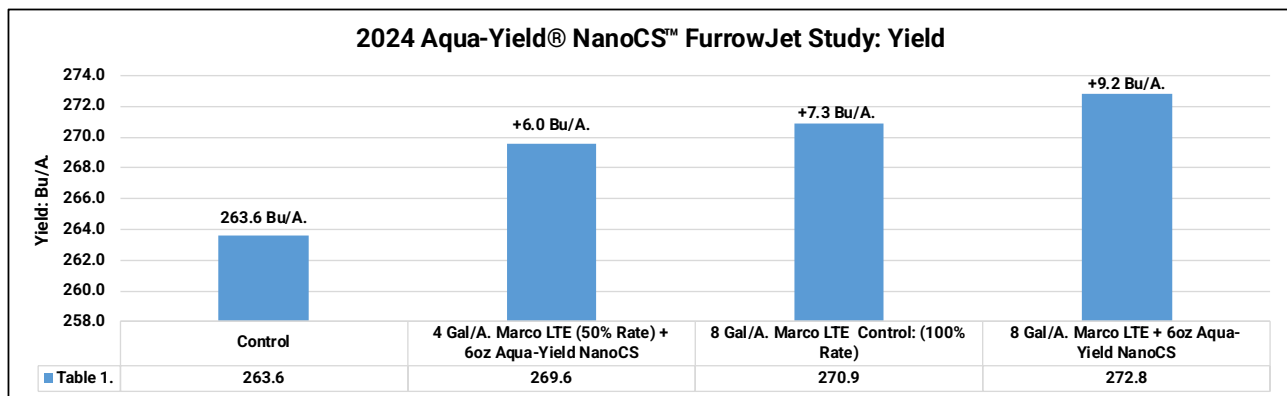

AQUA-YIELD®

**NanoCS™**

## Aqua-Yield® NanoCS™ FurrowJet® Study Continued

**Results:** Table 1. illustrates yield results of all treatments. The control treatment brought yields of 263.6Bu/A. The 100% rate treatment at 8 Gal/A. of LTE resulted in yields of +7.3 Bu/A.

Aqua-Yield's 6oz NanoCS tank-mixed with 50%(4Gal) LTE rates resulted in +6.0 Bu/A. yield improvement over the control treatment. Finally, 6oz NanoCS + 8 Gal/A. of LTE resulted in yield gains of +9.2 Bu/A.



Table 2. illustrates the overall economics of the fertility study. Reducing LTE in-furrow applications by 50% and tank-mixing NanoCS resulted in economic gains of +\$27.41/A.

2024 was the PTI Farm's 4<sup>th</sup> year testing NanoCS. In 2021, NanoCS® resulted in +0.3 Bu/A. yield gains with corresponding net revenue gains of +\$6.87/A., in 2022, NanoCS resulted in +3.3 Bu/A. yield gains with corresponding net revenue gains of +\$29.20/A. with both years using 10-18-4 in-furrow starter fertilizer. Finally in 2023, we saw yield increases of +8.0 Bu/A. along with economic gains of +\$13.81/A. with a 6-20-4.

As farmers, we are always interested in the ability to reduce fertilizer rates without sacrificing yield or profitability and we look forward to testing this product for a fifth year in 2025.

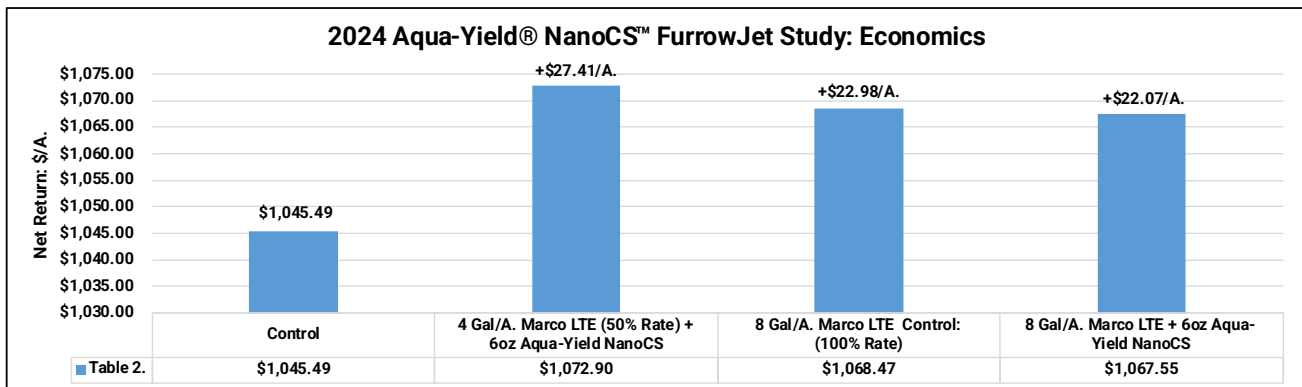

Planting Date: May 11<sup>th</sup>    Hybrid: GH 15J91    Population: 36K    Row Width: 30"    Rotation: CAB    Corn Price: \$4.08    NanoCS: \$8.67/A.    Marco LTE: \$4.60/Gal

## Pritchard Ag LLC FurrowJet Study



**Objective:** This in-furrow application trial applied via FurrowJet® (Figure 1.) evaluates yield and economics of 4 different Pritchard Ag products. Micro Pak, Brix Builder, Humate, and Sea Kelp were the four products to make up the FurrowJet® Pritchard blend.

Micro Pak is a combination of four elements; Boron, Copper, Manganese, and Zinc. This is essential to plant nutrition for the prevention and treatment of micronutrient deficiency.

Brix Builder is an auxiliary plant substance that is designed for soil and foliar use to enhance plant formation, as well as to stimulate microbial propagation.

Humate is a natural soil conditioner that acts as an organic chelator and microbial stimulator.

Sea Kelp is designed to be used as part of a well balanced plant nutrient program.

**Results:** Tables 1-2. Illustrates the Pritchard Ag nutrition program resulted in yield gains of +14.5 Bu/A. with corresponding net returns of +\$39.10/A.

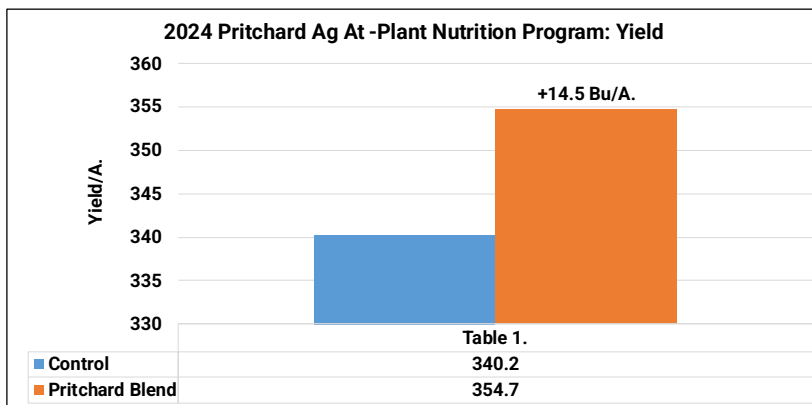

Figure 1. FurrowJet®

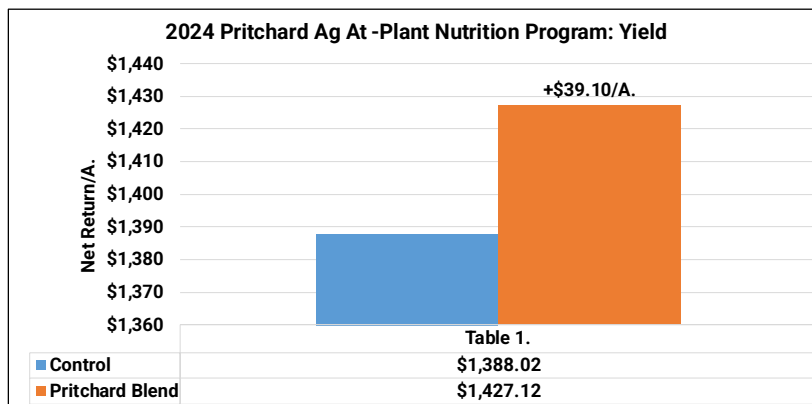
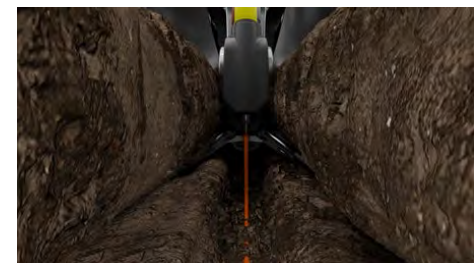

Figure 2: FurrowJet® In-Furrow



Planting Date: April 25<sup>th</sup> Hybrid: DKC 66-06 Trecepta Population: 36K Row Width: 30" Rotation: CAC Corn Price: \$4.08 Pritchard Blend: \$20.06/A.

## AgroLiquid® Micro 500® FurrowJet Study



**Objective:** This in-furrow application trial applied via FurrowJet® (Figure 1.) evaluates yield and economics of Micro500®, an in-furrow micronutrient pack.

Micro 500 contains the essential micronutrients zinc, manganese, iron, copper, and boron. This liquid micronutrient fertilizer not only covers multiple micronutrient requirements, but it's also easy to apply. This fertilizer is safe to apply with many other nutrition and crop protection products, so you don't have to make an extra trip. The micronutrients in Micro 500 stimulate healthy growth in a variety of ways, and work synergistically with one another.

**Results:** Micro 500 at a rate .5 Gal/A. offered yield responses of +6.8 Bu/A. and proved positive economic gains +\$18.26/A. Increasing rates to .75 Gal/A. proved yield responses of +7.8 Bu/A. resulting in economic gains of +\$17.60/A.

Composition Guarantee Analysis	
Total Boron (B)	0.02%
Copper (Cu)	0.25% <small>.25% Water Soluble Copper (Cu)</small>
Iron (Fe)	0.37% <small>0.37% Water Soluble Iron (Fe)</small>
Manganese (Mn)	1.20% <small>1.20% Water Soluble Manganese (Mn)</small>
Zinc (Zn)	1.80% <small>1.80% Water Soluble Zinc (Zn)</small>

Figure 1. FurrowJet®

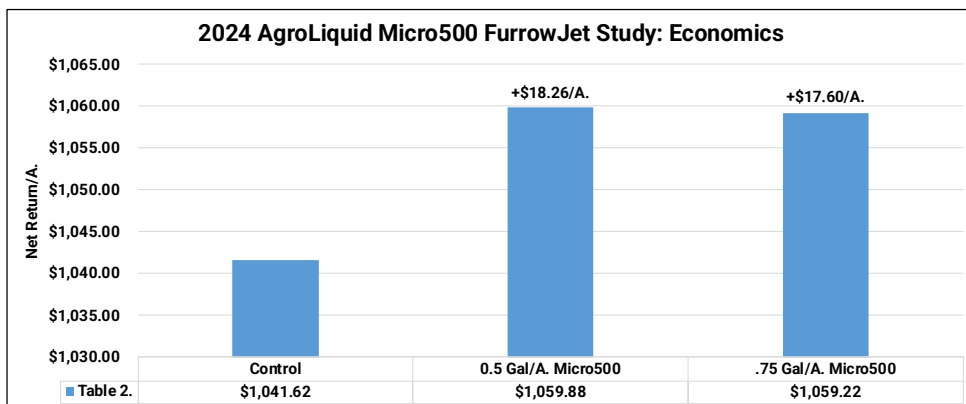
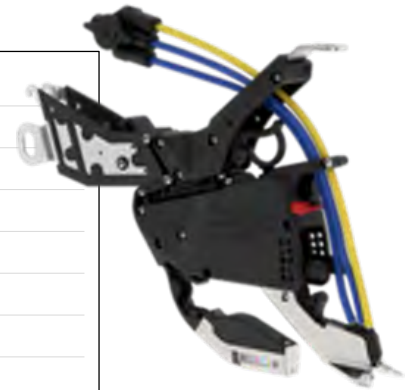
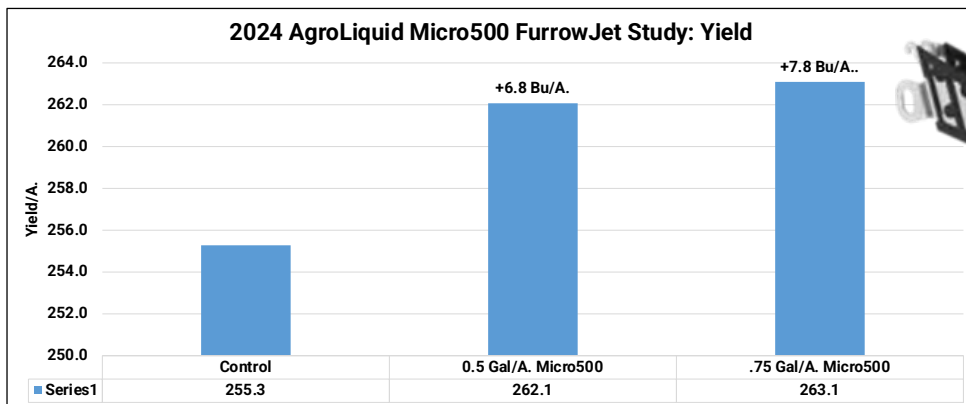

Planting Date: May 10<sup>th</sup> Hybrid: GH 12U11 Population: 36K Row Width: 30" Rotation: CAC Corn Price: \$4.08 Micro500: \$18.98/Gal.

## AgroLiquid® LiberateCa™ FurrowJet Study

**Objective:** This in-furrow application trial applied via FurrowJet® (Figure 1.) evaluates yield and economics of LiberateCa™, an in-furrow calcium fertilizer.

LiberateCa is a liquid fertilizer designed to easily prevent or correct calcium deficiency for all types of crops. LiberateCa is effective in many different soil types, and it can be applied in many different ways. The versatile nature of this fertilizer makes it easy to prevent calcium deficiencies or correct them when signs appear.

**Results:** LiberateCa at a rate .25 Gal/A. offered yield responses of +6.6 Bu/A. and proved positive economic gains +\$19.93/A. When the rate is increased to .50 Gal/A. yield responses increased to +4.8 Bu/A. resulting in economic gains of +\$5.59/A. Figure 1. FurrowJet®



**Composition Guarantee Analysis**

**Calcium (Ca)    3.00%**

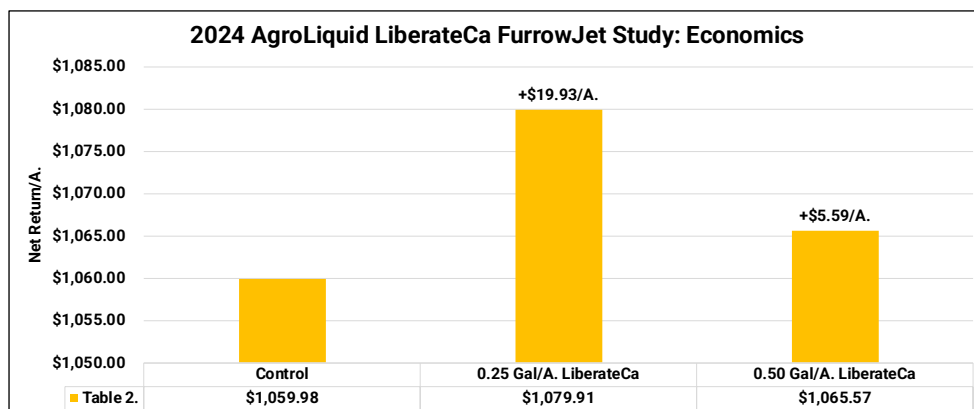
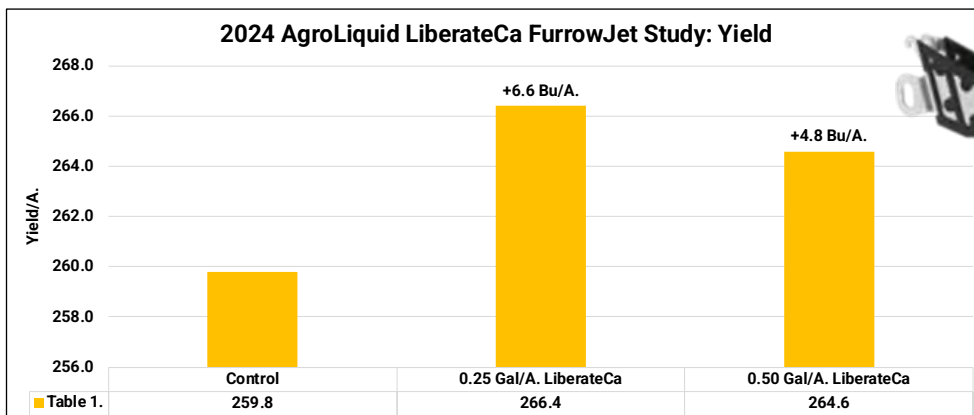

Planting Date: May 10<sup>th</sup> Hybrid: GH 12U11 Population: 36K Row Width: 30" Rotation: CAC Corn Price: \$4.08 LiberateCa: \$28/Gal.



## Ethos® Elite FurrowJet® Study

**Objective:** This FurrowJet® system (Figure 1.) trial evaluates the yield and net return of Ethos® Elite LFR®, an insecticide/biofungicide that combines an effective and trusted pyrethroid insecticide, bifenthrin (of Capture® LFR®), with two proprietary biologicals, *Bacillus velezensis* and *Bacillus subtilis*, for a broad spectrum of control against seedling and early-season diseases and soilborne pests.

This combination defends against insect pest such as corn rootworms, wireworms, grubs, seed corn maggots, cutworms, and common stalk borers. This also defends against diseases such as Fusarium, Pythium, Rhizoctonia and Phytophthora.

The bio-fungicide in Ethos Elite forms a protective barrier on root surfaces and builds over time as spores germinate and colonize roots and root hairs.

**Results:** Ethos XB treatments applied through FurrowJet® system offered positive yield gains of +11.7 Bu/A. (Table 1.) Seven years of testing (2018-2024) has realized average yield gains of +8.2 Bu/A. along with an average return on investment of +\$16.39/A. (Table 2.)



Active Ingredients:	By Wt.
Bifenthrin **:	15.7%
<i>Bacillus velezensis</i> strain RTI301 **:	2.5%
<i>Bacillus subtilis</i> strain RTI477 **:	2.5%
Other Ingredients:	79.3%
	100.0%

Figure 1.

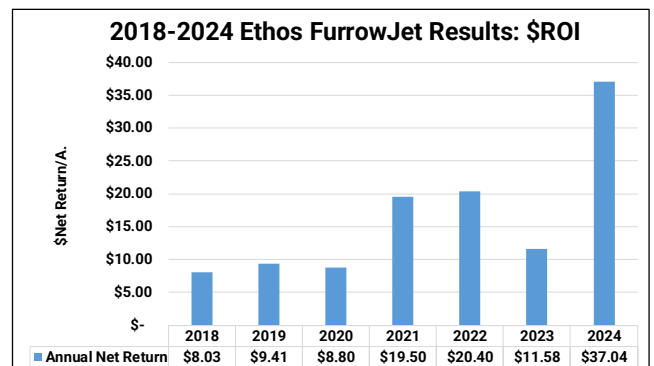
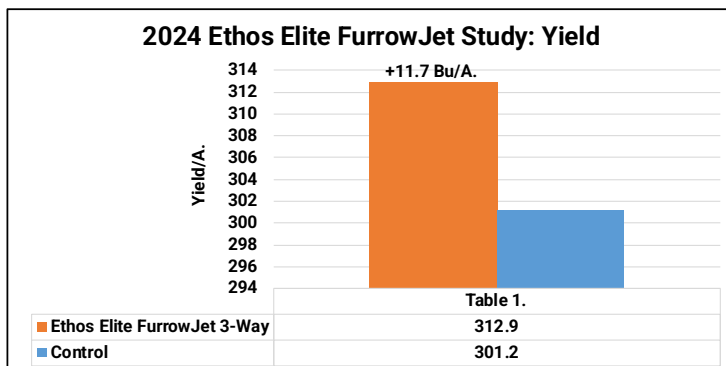

Planting Date: May 12<sup>th</sup> Hybrid: DKC 65-95 Population: 36K Row Width: 30" Rotation: CAC Corn Price: \$4.08 Ethos Elite: \$10.7/A. Rate: 5.3 oz/A

## Xyway® LFR® FurrowJet® Study

**Objective:** To evaluate the yield and economic return of Xyway® LFR®, a fungicide with the active ingredient Flutriafol (Figure 1). Xyway® LFR® fungicide is promoted as a revolutionary at-plant fungicide formulation that provides season-long disease protection from the inside out, root, stalk, and leaf.

This study evaluates Xyway® LFR® applied in various soil applied situations. First, Xyway® LFR® is evaluated as an in-furrow treatment applied through FurrowJet®, a planter fertilizer attachment that enables placement of fertilizer on the seed as well as 3/4" on each side of the seed (Figure 2). To achieve this dual-band placement, the wings on FurrowJet® system angle downward to cut into the sidewall and place fertilizer alongside the seed in a dual-band. By doing this, lifting and fracturing can occur that potentially could remove soil smearing or compaction created by disc openers. In this study, Xyway® LFR® is evaluated in FurrowJet® Wing placement only.

Secondly, to focus on applications of Xyway® LFR® further away from the seed, a second treatment was also evaluated with Conceal®. A Conceal® system is a unique planter attachment that allows growers to place product in a high concentration dual or single band positioned 3" away from the seed trench (Figure 3.) in depths near 1.5". The Conceal® system uses existing planter space, utilizing a backswept knife located with-in the center of the planter's gauge wheels. As product is applied, it is sealed within the soil profile by the gauge wheels.



Figure 1.

EPA Reg. No. 279-9638	EPA Est. No. 279-DE-001
Active Ingredient:	By Wt.
Flutriafol .....	26.4%
Other Ingredients: .....	73.6%
TOTAL:	100.0%

Contains 2.5 pounds per gallon of the active ingredient flutriafol. Suspension Concentrate.



Figure 2. FurrowJet® In-Furrow Planter Attachment



Figure 3. Conceal Dual Placement 3" from Seed Trench



## Xyway® LFR® FurrowJet® Study Continued

**Results:** Both placements offered positive yield and economic return. FurrowJet treatments tallied impressive +19.1 Bu/A. gains with net returns of +\$60.30/A. Conceal treatments also offered similar gains of +16.0 Bu/A. gains with net returns of +\$47.65/A.

However, Xyway® LFR® placed in furrow with FurrowJet® wings offered a +3.1 Bu/A. yield gain over Conceal dual band treatments. This difference in placement resulted in FurrowJet® gains of +\$12.65/A.

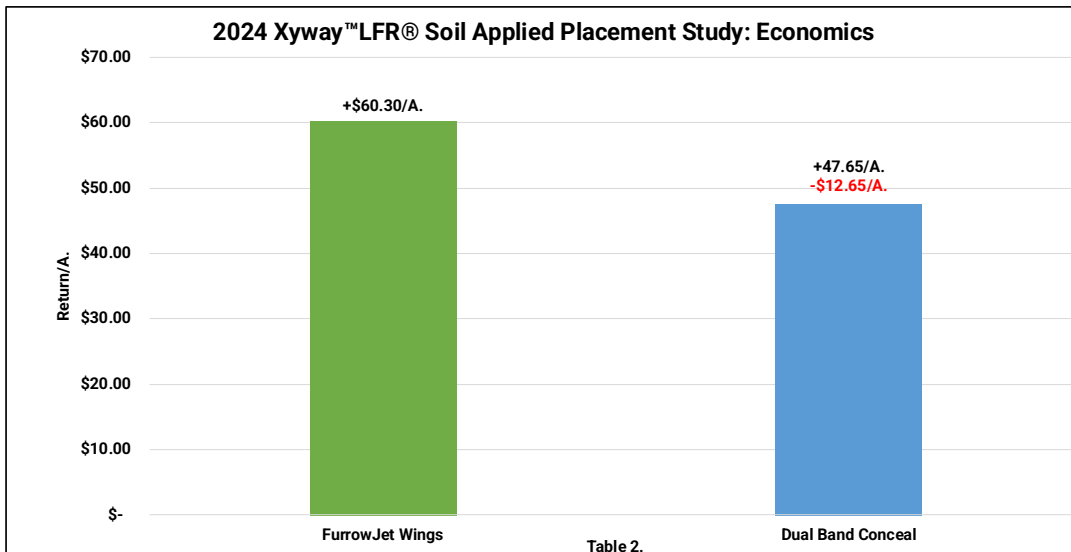
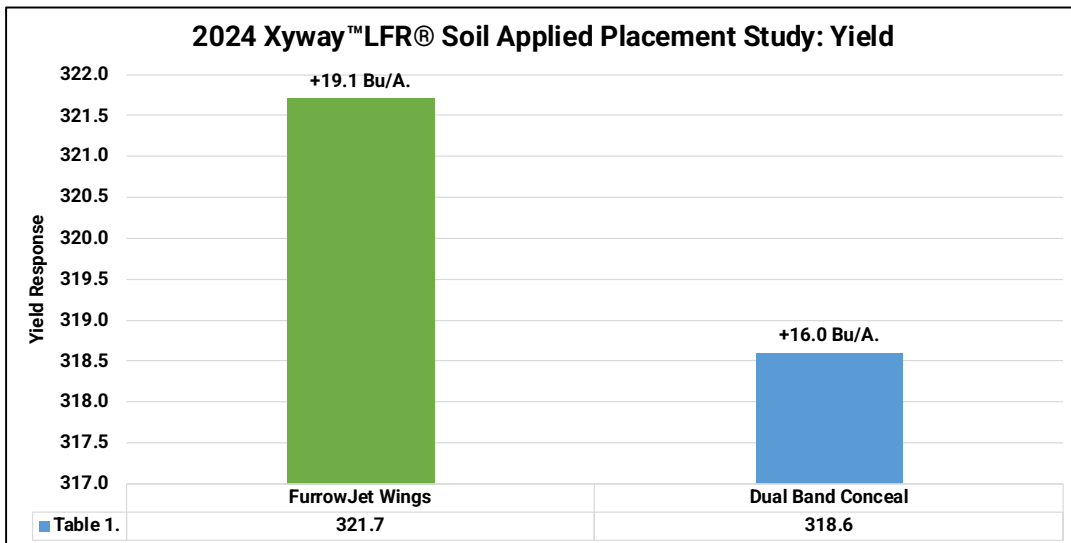

Planting Date: May 12<sup>th</sup> Hybrid: DKC 65-95 Population: 36K Row Width: 30" Rotation: CAC Corn Price: \$4.08 Xyway LFR: \$17.63/A.

## Capture® LFR® In-Furrow Study

**Objective:** This in-furrow application trial applied via FurrowJet® (Figure 2.) evaluates yield and economics of Capture® LFR®, an in-furrow liquid insecticide containing the active ingredient Bifenthrin (Figure 1.) in a liquid fertilizer ready (LFR) formulation.

Figure 1.

EPA Reg. No. 279-3302	EPA Est. 279-NY-1
Active Ingredient:	By Wt.
Bifenthrin* : .....	17.15%
Other Ingredients: .....	82.85%
	100.0%

\*Cis isomers 97% minimum, trans isomers 3% maximum.  
This product contains 1.5 pounds active ingredient per gallon.

Capture LFR controls seed and seedling pests such as wireworm, corn rootworm, cutworm, grubs, armyworm, seed corn maggot and common stalk borer.

**Results:** Capture LFR offered yield responses at +8.9 Bu/A. and proved positive economic gains +\$23.84/A.

Figure 1. FurrowJet®

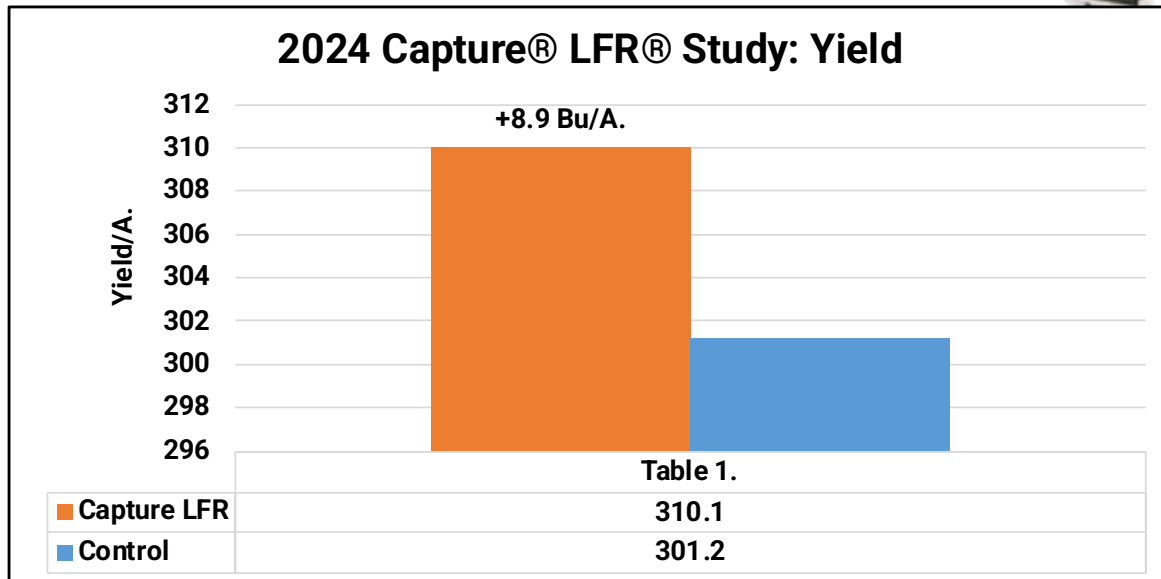
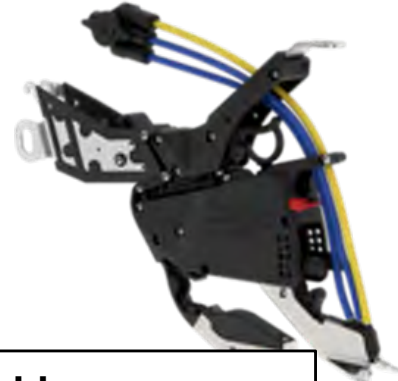

Planting Date: May 10<sup>th</sup> Hybrid: DKC 65-95 Population: 36K Row Width: 30" Rotation: CAC Corn Price: \$4.08 Capture LFR: \$12.47/A.

## FurrowJet® Nitrogen Study

**Objective:** Farmers often ask the question if it's safe to apply UAN nitrogen in-furrow on the planter. This study evaluates 25-GAL UAN 32% nitrogen placed in FurrowJet® dual-band wings.

FurrowJet® is a planter fertilizer attachment (Figure 1.) that enables placement of not only an in-furrow starter fertilizer, but also a dual-band of fertilizer 3/4" on each side of the seed (Figure 2). To achieve this dual-band placement, the wings on FurrowJet® system angle downward to cut into the sidewall and place fertilizer alongside the seed in a dual-band. By doing this, lifting and fracturing can occur that potentially could remove soil smearing or compaction created by disc openers. (Figure 3.) Additionally, closing wheel systems following FurrowJet® wings have a better opportunity to close the seed trench, remove air pockets, and allow for good seed-to-soil contact.

**Results:** The tables below illustrate the effect of applying 32% UAN Nitrogen at 25 Gal/A through FurrowJet® system in the 2024 growing season. This application proved agronomic and economic losses of **-43.2 Bu/A.** and **-\$176.26/A.** respectively. UAN 32% has a salt index of 7.78lb/gal, which is too high to be seed safe.

Figure 1. FurrowJet®



Figure 2: FurrowJet® 3-Way Placement

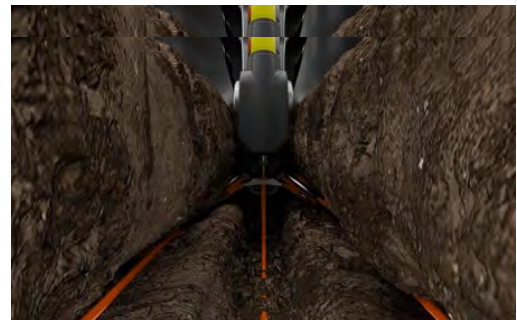
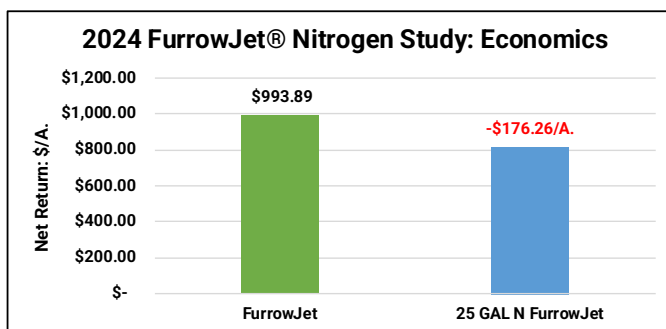
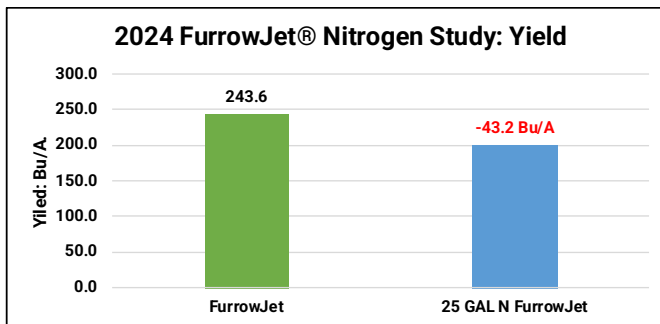

Figure 3: Seed/Root Burn due to Nitrogen



Product	Salt Index lb/gal	Value relative to 10-34-0
10-34-0	2.25	1.0
7-21-7	3.04	1.33
28-0-0	6.75	2.96
32-0-0	7.78	3.41
12-0-0-26	30.9	13.55

Planting Date: May 25<sup>th</sup>    Hybrid: Golden Harvest 12U11    Tillage: Strip-Till    Population: 36K    Row Width: 30"    Rotation: CAB    Corn Price: \$4.08

## Corn Summary of 2024 FurrowJet® Applications

Study	Classification	Yield (Bu/A.)	\$ROI
NewFields Ag Irrigated High Management Corn At- Plant	Starter Fertilizer/ Nitrogen	14.2	\$ 64.76
AgXplore Irrigated High Management Corn At- Plant	Starter Fertilizer/ Nitrogen	9.8	\$ 62.48
Corteva Irrigated High Management Corn At- Plant	Starter Fertilizer/ Nitrogen	8.1	\$ 61.49
NMS Irrigated High Management Corn At- Plant	Starter Fertilizer/ Nitrogen	8.1	\$ 61.49
Xyway LFR	Fungicide	19.1	\$ 60.30
Marco Irrigated High Management Corn At- Plant	Starter Fertilizer/ Nitrogen	10.2	\$ 44.79
Ethos Elite LFR	Insecticide/ Fungicide	11.7	\$ 37.04
Marco QuickGrow LTE 4Gal	Starter Fertilizer	6	\$ 36.08
Marco QuickGrow LTE 8Gal	Starter Fertilizer	9.2	\$ 30.74
Marco LTE 4 Gal + Aqua-Yield Nano CS 6oz	Starter Fertilizer Enhancer	6	\$ 27.41
Capture LFR	Insecticide	8.9	\$ 23.84
Marco LTE 8 Gal + Aqua-Yield Nano CS 6oz	Starter Fertilizer Enhancer	7.3	\$ 22.98
Marco LTE 8 Gal	Starter Fertilizer	9.2	\$ 22.07
AgroLiquid LiberateCa 0.25 Gal	Starter Fertilizer	6.6	\$ 19.93
AgroLiquid Micro 500 0.5 Gal	Starter Fertilizer	6.8	\$ 18.26
AgroLiquid Micro 500 0.75 Gal	Starter Fertilizer	7.8	\$ 17.60
May 6th Corn Plant Date with Starter	Starter Fertilizer	12.9	\$ 15.39
QLF Irrigated High Management Corn At- Plant	Starter Fertilizer/ Nitrogen	26.7	\$ 14.53
April 16th Corn Plant Date with Starter	Starter Fertilizer	12.6	\$ 13.76
Envita 100% N	Biological + Nitrogen	6.6	\$ 12.03
QLF Dryland High Management Corn At- Plant	Starter Fertilizer/ Nitrogen	25.2	\$ 8.41
Nurizma 1oz	Insecticide	7.8	\$ 6.42
AgroLiquid LiberateCa0.5	Starter Fertilizer	4.8	\$ 5.59
Envita -10% N	Biological + Nitrogen	1.3	\$ 3.40
May 11th Corn Plant Date with Starter	Starter Fertilizer	9.1	\$ (0.52)
Green Lightning Plasma Activated Water In-Furrow 4 Gal	Nitrogen	-1.3	\$ (1.75)
Pivot Bio ProveN40: 25% Reduction + ProveN40	Biological + Nitrogen	-1.4	\$ (1.90)
Green Lightning Plasma Activated Water In-Furrow 8 Gal	Nitrogen	-4.7	\$ (12.07)
Green Lightning Plasma Activated Water In-Furrow 12 Gal	Nitrogen	-5.6	\$ (12.19)
Green Lightning Plasma Activated Water In-Furrow 16 Gal	Nitrogen	-10	\$ (26.59)
May 20th Corn Plant Date with Starter	Starter Fertilizer	2.5	\$ (27.86)
May 26th Corn Plant Date with Starter	Starter Fertilizer	1.2	\$ (32.76)
100% Green Lightning Replacement N	Nitrogen	-44.8	\$ (57.46)
Furrow Jet Nitrogen 25 Gal	Nitrogen	-43.2	\$ (176.26)
Average		4.4	\$ 10.04

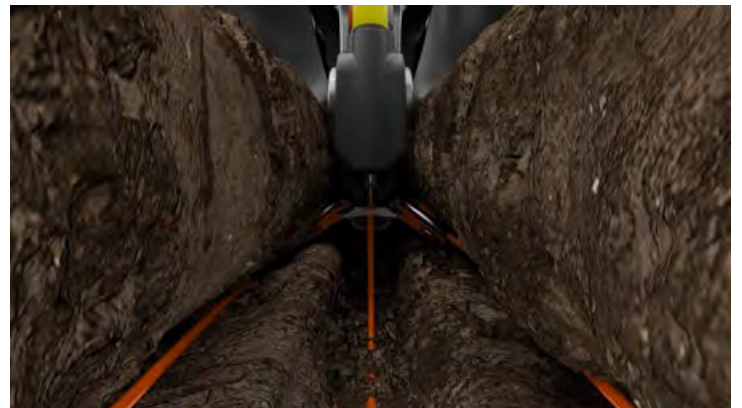

## Single/Double/Triple Nitrogen Timing Study

**Objective:** To compare 100% single applications of surface applied broadcast Weed-N-Feed (WNF) 32% UAN treatments (Figure 1.) to adding a second application of side-dress nitrogen (Figure 3), and to a third application of adding at-plant Conceal nitrogen (Figure 3).

Conceal® system is a unique planter attachment that allows growers to place nitrogen in a high concentration dual or single band positioned 3" away from the seed trench in depths near 1.5" (Figure 2). The Conceal® system uses existing planter space, utilizing a backswept knife located with-in the center of the planter's gauge wheels (Figure 1). As nitrogen is applied, it is sealed within the soil profile by the gauge wheels, preventing potential volatilization losses that is typically problematic with surface type nitrogen applications.

**Results:** Table 1. illustrates that nitrogen applied as second application with side-dress offered +4.7 Bu/A. yield increase with net gains of +\$9.06/A., while third applications of side-dress and at-plant Conceal resulted in +14.0 Bu/A. gains and net return of +\$46.98/A.

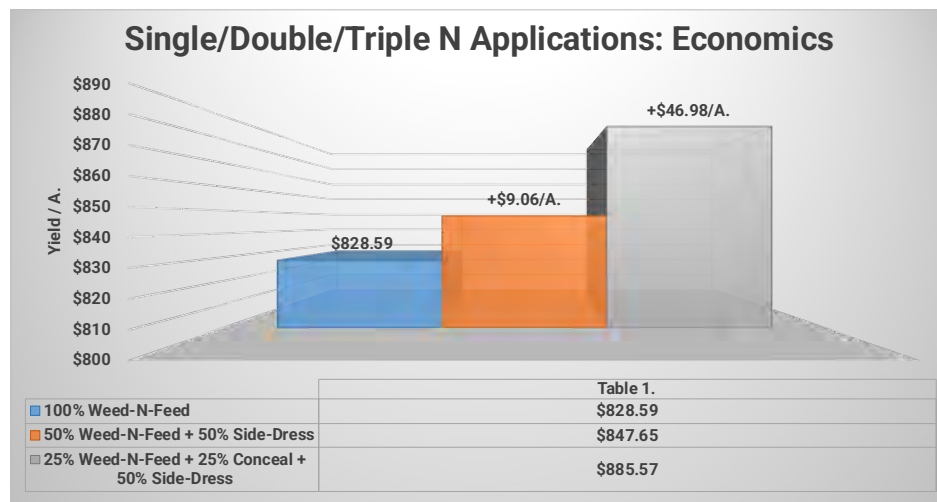

Figure 1. Weed-N-Feed Nitrogen



Figure 2. Conceal At-Plant Nitrogen



Figure 3. Side-Dress Nitrogen



Planting Date: May 9<sup>th</sup> Hybrid: Wyffels 6886VT2P Population: 36K Row Width: 30" Rotation: CAC Corn Price: \$4.08 N Price: \$0.58/# App: \$10

## Single Band vs. Dual Band Conceal® Nitrogen Study

**Objective:** To compare dual band versus single band applications of nitrogen in an at-plant scenario using Conceal®. Both treatments consist of 50% of 240lbs total nitrogen at planting, all using UAN 32%.

A Conceal® system is a unique planter attachment that allows growers to place nitrogen in a high concentration dual or single band positioned 3" away from the seed trench (Figure 1.) in depths near 1.5". If corn is planted at a 2" depth, Conceal® system fertilizer placement is 3X-0.5X1 in single bands and 3X-0.5X2 in dual bands.

Conceal® uses existing planter space, utilizing a backswept knife located within the center of the planter's gauge wheels (Figure 1). As nitrogen is applied, it is sealed within the soil profile, preventing potential volatilization losses typically seen with surface type nitrogen applications.

**Results:** Table 1. illustrates that dual band applications of nitrogen out-yielded single band applications by +2.8 Bu/A. These yield gains consequently equated to additional net returns of +\$11.26/A. (Table 2).

Five year data over the time frame of 2020 to 2024 has shown dual band applications of nitrogen have proven yield increases of +5.0 Bu/A. along with net returns of +\$32.53/A.

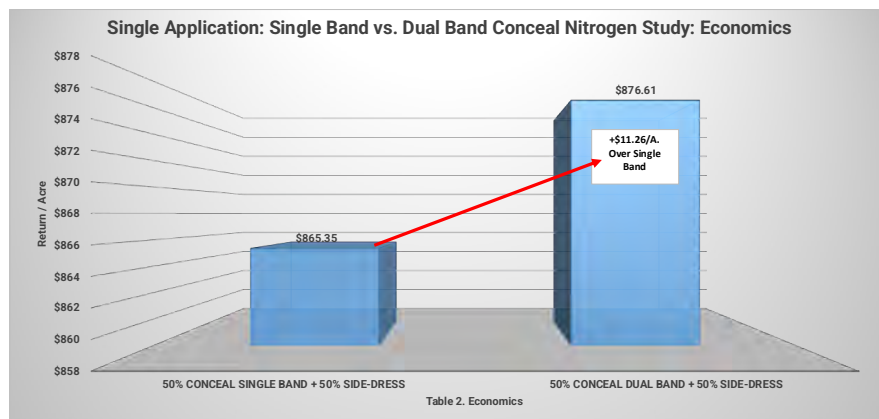
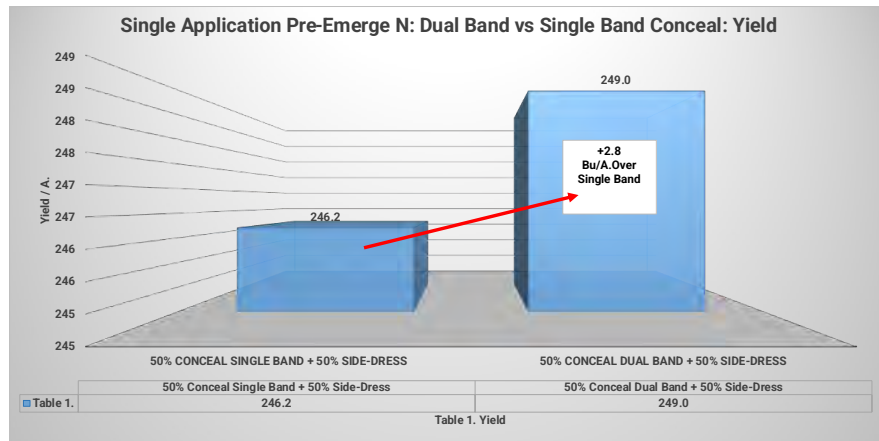

Planting Date: May 9<sup>th</sup>    Hybrid: Wyffels 6886VT2P    Population: 36K    Row Width: 30"    Rotation: CAC    Corn Price: \$4.08    N Price: \$0.58/#



## Multi-Year Nitrogen Rate/Placement Study

**Objective:** This 8-year long-term study evaluates the performance of seven different nitrogen rate and placement programs. These seven programs consist of single one and done nitrogen programs, 2-way split applications, and even 3-way split programs. All treatments are applied using 32% UAN liquid nitrogen. As a baseline, the 50% WNF + 50% V6 Side-Dress (Treatment #2) is facilitated as the control for this trial.

1.	100% Weed-N-Feed (WNF):	240# N as Surface applied 32% UAN	Single Applications
2.	50% WNF+50% Side-Dress (SD):	120# N WNF+ 120# N V6 side-dress: "Control"	Dual Split Applications
3.	50% Conceal® Single Band+50% SD:	120# N Conceal® Dual Bands + 120# N V6 SD	
4.	50% Conceal® Dual Band+50% SD:	120# N Conceal® Dual Bands + 120# N V6 SD	
5.	25% Conceal® Dual Band+50% SD:	60# N Conceal® Dual Bands + 120# V6 SD	
6.	75% Conceal® Dual Band+50% SD:	180# N Conceal® Dual Bands + 120# N V6 SD	Triple Split Applications
7.	25% Conceal®+25%WNF+50% SD:	90# N WNF + 90# N Conceal® Dual Bands + 120# SD	

**Results:** Table 1. illustrates economic results of all seven nitrogen programs. Only the 100% single application Weed-N-Feed performed less than the control with a loss of **-\$19.06/A.**

The Triple Split nitrogen rate treatment (25%WNF + 50% Conceal® Dual Band+50 SD) offered the largest gains over the control with net return of +\$37.92/A.

All other programs offered economic gains ranging from +\$9.56/A. to \$28.96/A. over the 50% Weed-N-Feed + 50% side-dress control.

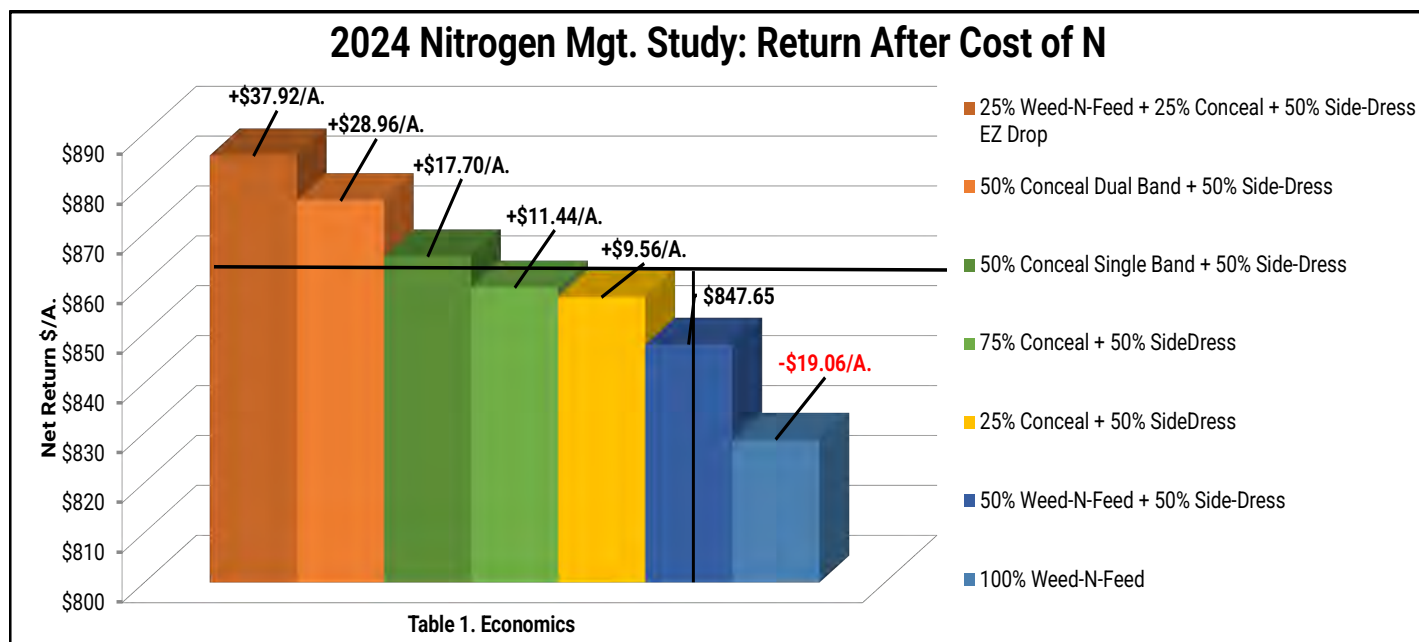

## Multi-Year Nitrogen Rate/Placement Study

Table 2. focuses on multi-year net return over the time period of 2017-2024. The top nitrogen program over the 8-yr period has been the triple split program (Treatment #7) and has resulted in positive economic returns of +\$47.22/A., compared to the 50% WNF + 50% side-dress control (Program #3). This top performer has also offered a +\$79.88/A. increase over the lowest return application, a one and done 100% Weed-N-Feed program.

To help understand the efficiency of the applications, we evaluated adjusting nitrogen rate by +25% and -25%. Adding 25% more nitrogen has been the 2<sup>nd</sup> overall highest net return after the cost of N, albeit **-\$24.61/A.** less than the top triple split program.

Lowering nitrogen rate by 25% has suffered with decreased returns of **-\$25.37/A.** compared to the control. However, please note this -25% reduced rate of N, still offered +\$7.29/A. above the single application 100% WNF rate of N.

Single application nitrogen programs have posted negative economic returns of **-\$32.66/A.** compared to the control and **-\$79.88/A.** off from the top triple split program.

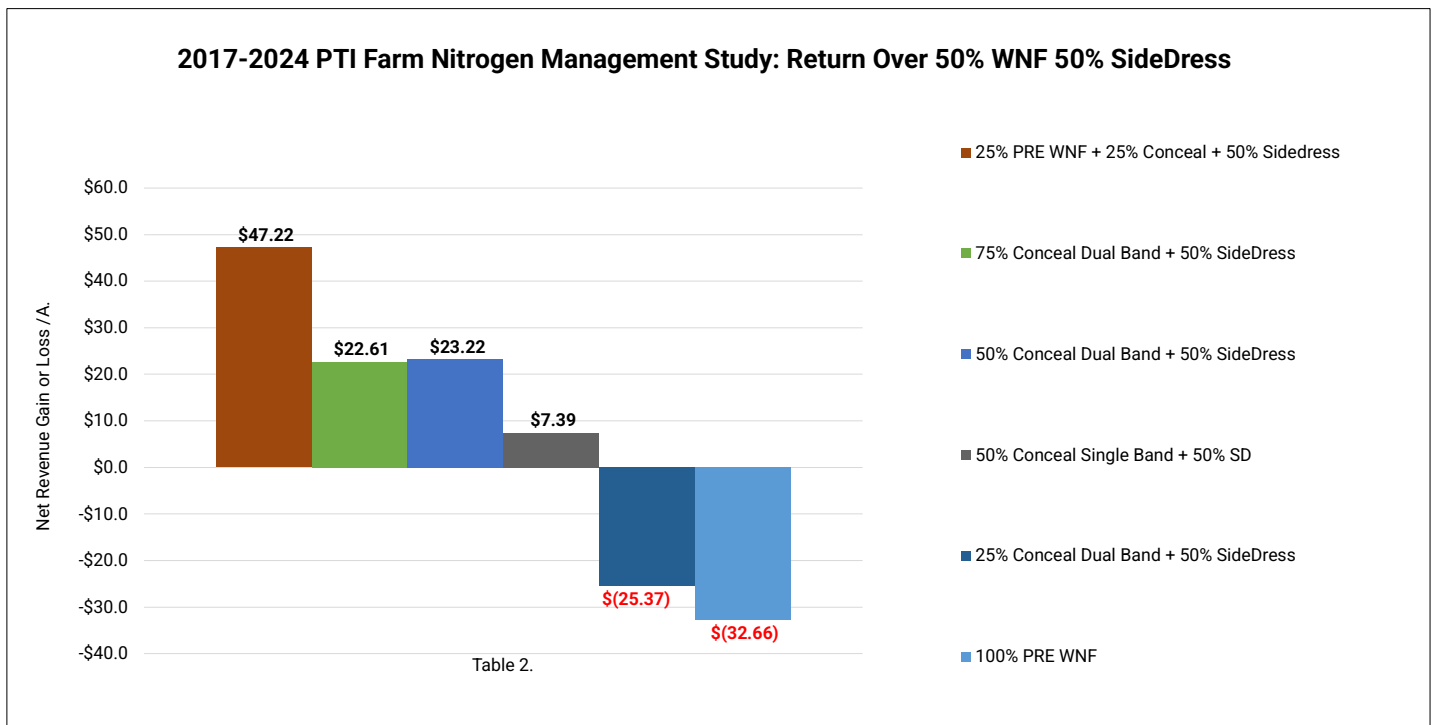

## Nitrogen Sealer Study

**Objective:** To evaluate the yield and economic impact of implementing nitrogen sealers when side-dressing corn with liquid nitrogen (N). Nitrogen sealers from Nitrogen Sealing Systems in Catlin, IL are a pair of coulters that attach to a side dress unit behind the knife or high-pressure injection nozzle (Figure 1-2). Sealers are designed to lift and redirect soil over top of the injection point of nitrogen, collapsing and sealing the trench, protecting nitrogen that could otherwise volatilize.

Volatilization is a form of N loss that occurs when nitrogen is applied on the soil surface without incorporation by tillage or rainfall events. In this event, applied nitrogen converts to ammonia, a gaseous form that can easily escape into the atmosphere. In a side-dress situation, this can occur when nitrogen is applied and not sealed or covered properly. If coulters slots open or become exposed to sunlight, air, wind, and increased temperatures after application, volatilization can occur.

**Results:** Nitrogen sealers proved yield gains of +6.9 Bu/A., while capturing an additional +\$28.29/A. Table 1. illustrates multi-year data over 2020-2024 have proved +8.1 Bu/A. yield gains with corresponding economic gains of +\$37.91/A.

At a cost of \$335/row on a 15-knife side-dress applicator, break-even would occur at 133 acres.



Figure 1. Nitrogen Sealers



Figure 2. Sealed row with soil berm

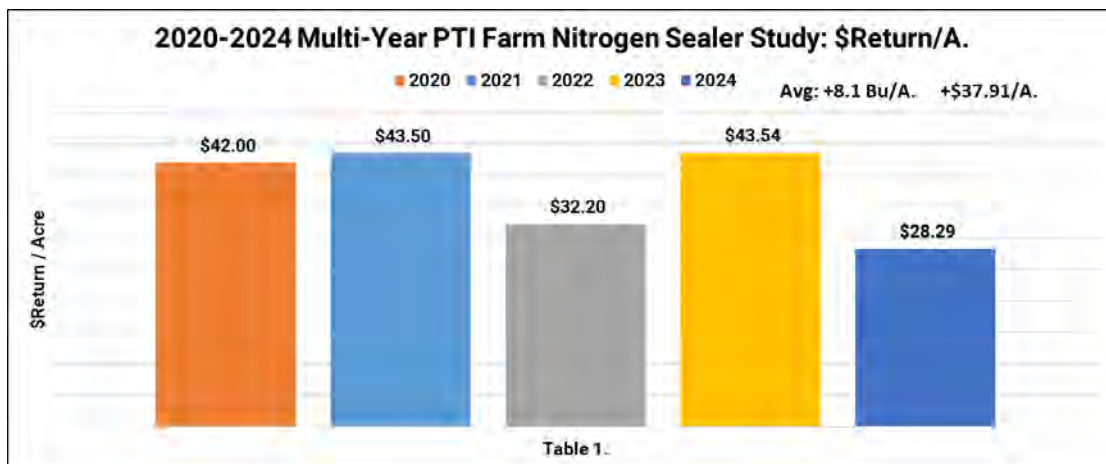

Planting Date: May 15<sup>th</sup>

Hybrid: Golden Harvest 12U11

Population: 36K

Row Width: 30"

Rotation: CAC

Corn Price: \$4.08

Side-Dress Timing: V3

Sealers from Nitrogen Sealing Systems \$335/Row

## Urea vs UAN Nitrogen Side-Dress Study

**Objective:** To evaluate yield and economics of 50# actual pounds of side-dressed nitrogen with dry urea (46-0-0) and liquid UAN (32-0-0).

All nitrogen applications were side-dressed with Miller N-Place™ Max side-dress applicator (Figures 1-2).

The right side of the toolbar allows the opportunity to band urea, while the left side allows for liquid banding.

Urea is applied via a dry tank and blower system that accurately places urea prills near the base of the corn plant. UAN is also applied via another on-board tank, and also bands liquid near the base of the plant. Both systems work to incorporate or cover the urea and UAN with soil to protect against volatilization.

Figures 1-2: Miller N-Place™ Max Side-Dress Toolbar



## Urea vs UAN Nitrogen Side-Dress Study

Figure 3 illustrates dry urea is applied in 6" band surrounding the corn plant. Urea on the soil surface removes leaf tissue burn concerns from typical broadcast or top dress applications. Cover wheels (Figure 5.) then follow the urea and mix or throw soil on top of the urea to protect it from volatilization.

Volatilization is the loss of N through the conversion of ammonium to ammonia gas, which is released into the atmosphere.

Figure 4 shows the liquid drops of the N-Place toolbar that also allow for banding of the liquid 32% UAN. UAN is placed in a 6" band surrounding the corn plant in - row. Just as the urea, the cover wheels follow the UAN and mix or throw soil on top of the UAN to protect it from volatilization.

Figure 3: Banded Urea on V6 Corn



Figure 5. Incorporating Cover Wheels



Figure 4: Banded Liquid UAN on V6 Corn

## Urea vs UAN Nitrogen Side-Dress Study

For dry urea applications, advanced flow and blockage visibility was implemented by pairing Clarity™ with the 20|20 monitoring system.

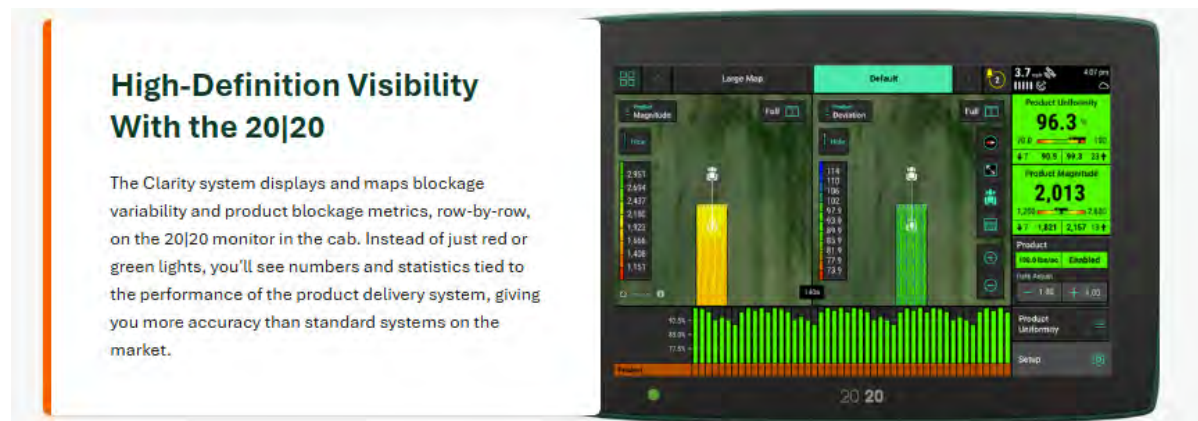

For liquid 32% applications, this bar was fitted with Pump Stack®, a liquid fertilizer hydraulic pump. It was paired with EMHD® and EM FlowSense™ (Figure 6.) to ensure a top-notch fertilizer application, as well as row control across the bar. EMHD® controls liquid application rates using an electromagnetic flow meter. This opens your options for a wider range of liquid products. EM FlowSense™ allows you to measure the rate of fertilizer you are applying on each row of the bar, to make you aware of any row-to-row variability that is occurring. With a Pump Stack® system, paired with EMHD®, and EM FlowSense™ you can be confident in your application rate across every row.



Figure 6. EMHD® + EM FlowSense™

## Urea vs UAN Nitrogen Side-Dress Study

**Results:** Table 1. illustrates that both nitrogen products performed similarly with 32% UAN offering a slight yield advantage of +2.4 Bu/A. However, due to urea priced at a lower cost/A., net returns fell to **-\$2.59/A.** for dry urea (Table 2.). More work needs to be done to accurately “throw or cover” soil onto the nitrogen product, without sacrificing crop safety. Once this is established, both nitrogen products should work comparatively.

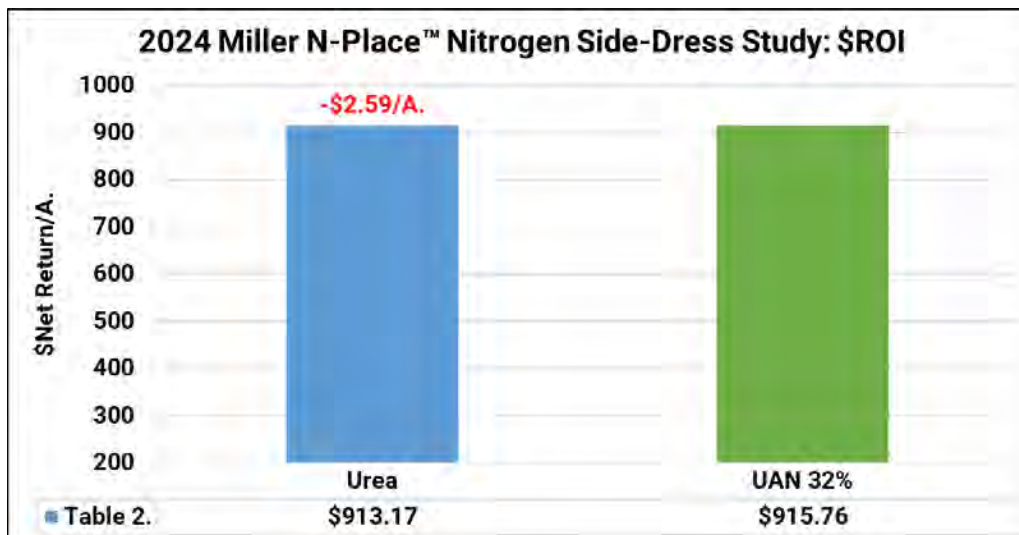
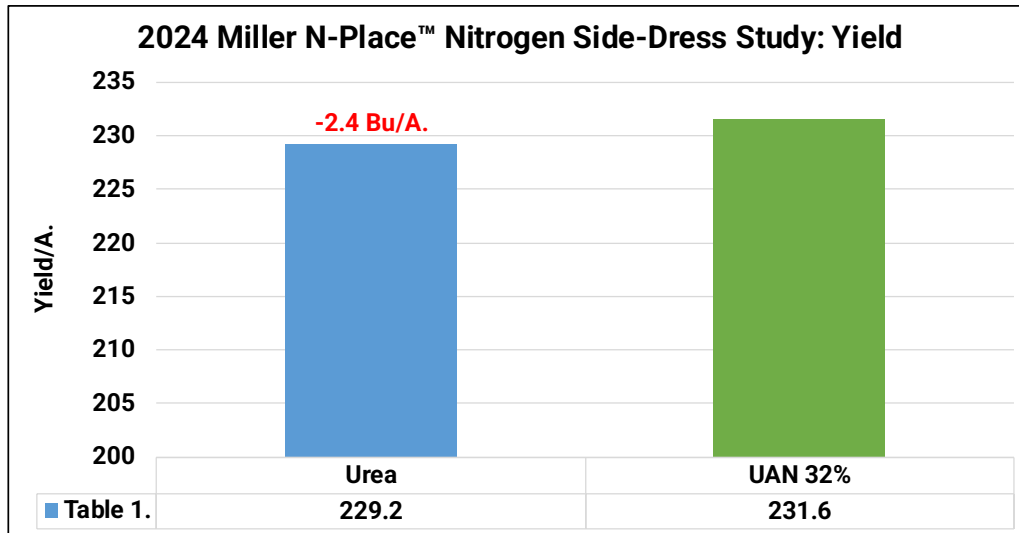

Planting Date: May 22<sup>nd</sup>    Hybrid: Becks 6374V2P    Population: 34K    Row Width: 30"    Rotation: CAB    Corn Price: \$4.08    UAN:\$0.58/#    Urea: \$0.43/#

## Conceal® K-Fuse® Potassium Study

**Objective:** To evaluate the yield and economics of NACHURS® K-Fuse® powered by Bio-K® (Figure 1.), a 6-0-12-12S potassium/sulfur product designed to be blended with UAN fertilizer and applied on the planter or at side-dress. For this study we applied three, five, and eight gallons of K-Fuse® at planting in a dual band Conceal® system application tank-mixed with 27 Gal/A. of UAN 32%. (Figure 2).

**Results:** In 2024, K-Fuse® applications reached agronomic optimum yield at the highest 8 Gal/A. Yield response ranged from +3 Bu/A. to +5.8 Bu/A. As for economics, Table 1. reveals 3 Gal/A. of K-Fuse® provided economic optimum rate with a positive return on investment of +\$22.44.

Table 2. reveals multi-year data from 2021-2024 where 5 Gal/A of K-Fuse® has proved economic optimum rate with a positive return on investment of +\$22.46/A. over the 4 year period.

Figure 1. Nachurs K-Fuse® Potassium Additive



**NUTRIENTS SUPPLIED (pounds per gallon):**

Total Nitrogen (N)	0.65
Soluble Potash (K <sub>2</sub> O)	1.30
Sulfur (S)	1.30

**Derived from:** Potassium Acetate, Ammonium Thiosulfate, and Urea.

**PRODUCT PROPERTIES:**

<b>Analysis:</b>	6-0-12-12S
<b>Weight:</b>	10.8 lbs. per gallon
<b>Specific gravity:</b>	1.30 kg/L
<b>pH:</b>	7.4-7.9
<b>Appearance:</b>	Clear, nearly colorless
<b>Odor:</b>	Ammonia odor

**GENERAL PRODUCT INFORMATION:**

NACHURS K-Fuse is designed to be blended with various other fertilizers to provide important nutrients needed to grow high-yielding crops. Primarily, NACHURS K-Fuses should be blended with UAN solutions for sidedress and/or fertigation application to provide two very critical elements - Potassium and Sulfur. It can also be mixed with APP and UAN for 2x2 and/or strip-till application to provide a more balanced nutrient program. NACHURS K-Fuse contains a proprietary additive which allows for more narrow mixing ratios with UAN solutions than other potassium products currently on the market. Always follow mixing recommendations so as to limit risk potential of forming low solubility potassium nitrate compounds. NACHURS K-Fuse should not come in close proximity to the seed under any circumstance (i.e. in-furrow placement).

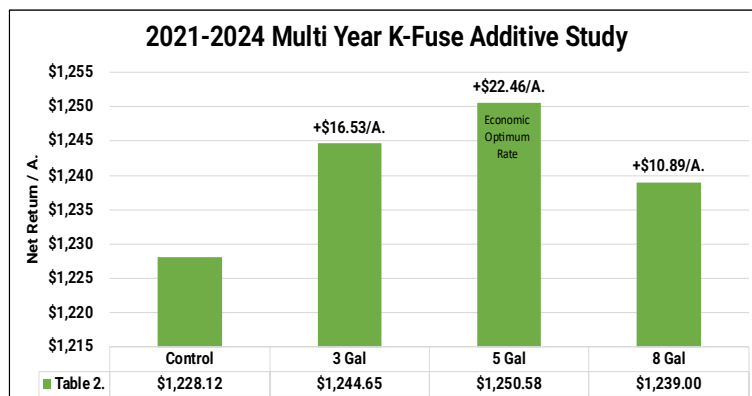
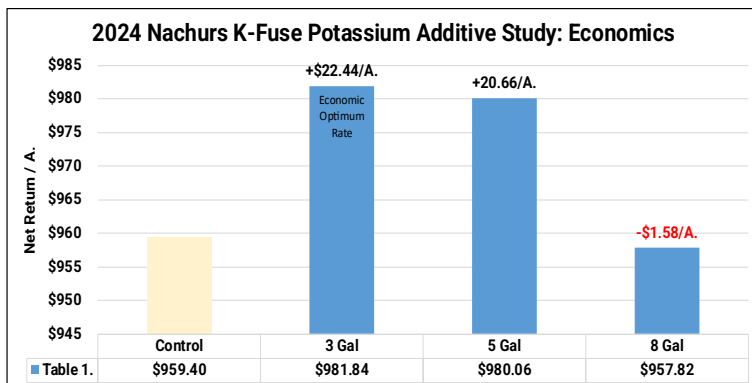

Figure 2. Conceal Dual Placement 3" from Seed Furrow, 1.5" in Depth

Planting Date: May 10<sup>th</sup> Hybrid: Golden Harvest 15J91 Population: 36K Row Width: 30" Rotation: CAB Corn Price: \$4.08 K-Fuse®: \$6.60/Gal \$30 Reallocation



## Aqua-Yield® NanoN+™ Conceal® Nitrogen Study

**Objective:** To evaluate yield and economics of NanoN+™ by AQUA-YIELD. NanoN+™ uses AquaYield nano liquid technology to improve nitrogen use efficiency. NanoN+™ can be added to most liquid fertilizer blends containing nitrogen to enhance uptake. Nano liquid products effectively work as a delivery system for nutrients and protects molecules from environmental losses and delivers them to plants at the cellular level. A process called endocytosis brings the nano liquid particles into the cell where the payload is delivered. This trial aims to establish the efficiency of Aqua-Yield’s NanoN+™ nano-liquid based fertility product in tandem with 32% UAN nitrogen fertilizer. NanoN+™ was applied at planting in a dual band Conceal® application (Figure 1).

Figure 1. Conceal® Placement

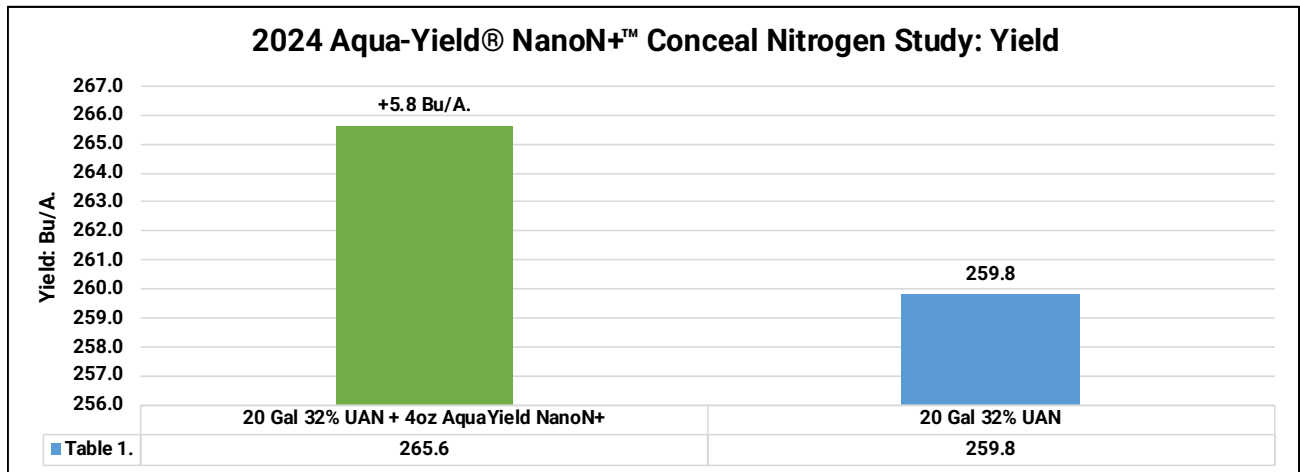

AQUA-YIELD®

**NanoN+**™

## Aqua-Yield® NanoN+™ Conceal® Nitrogen Study Continued

**Results:** Table 1. illustrates yield results of all treatments. Aqua-Yield's NanoN+™ tank-mixed with 20 Gal/A. of 32% UAN resulted in +5.8 Bu/A. yield improvement over the control.

Table 2. illustrates the overall economics of the fertility study where NanoN+™ resulted in positive economic gains of +\$19.28/A.

2022-2024 multi-year data has averaged +6.4 Bu/A. with economic returns of +\$27.23/A.

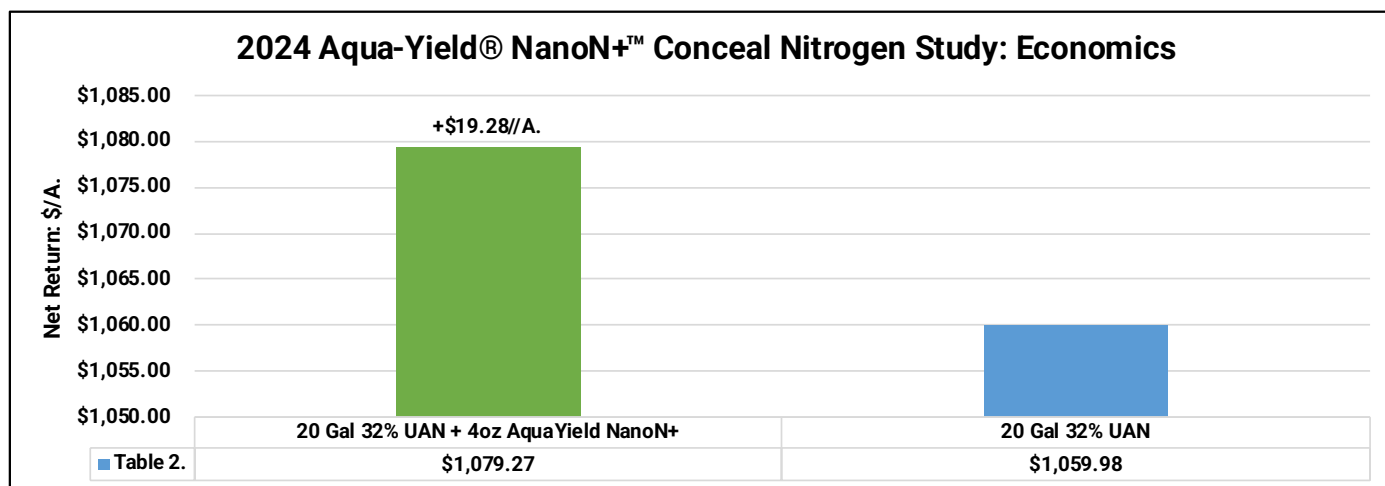
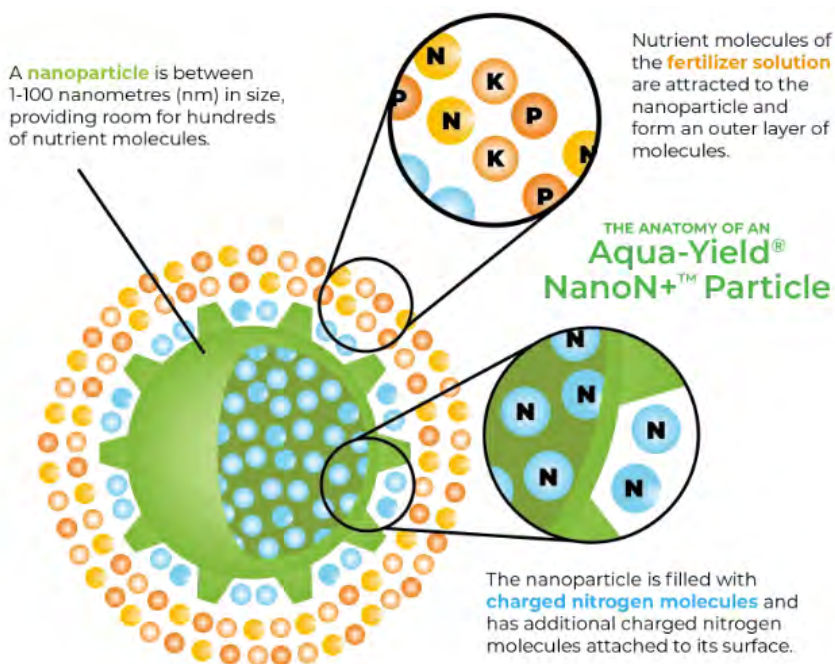

Planting Date: April 28th Hybrid: GH 15J91 Population: 36K Row Width: 30" Rotation: CAC Corn Price: \$4.08 NanoN+®: \$4.38/A.

## AgroLiquid® eNhanCe Conceal Study

**Objective:** This on planter application evaluates yield and economics of eNhanCe, a nitrogen fertilizer.

eNhanCe is unique among nitrogen fertilizers because it provides nitrogen alongside secondary and micronutrients like sulfur, manganese, and zinc. In this way, it not only provides needed sulfur, but also manganese and zinc. These micronutrients play a key role in nitrogen utilization.

**Results:** eNhanCe applied at a rate .125 Gal/A. offered yield responses of +5.0 Bu/A. and proved positive economic gains +\$18.20/A. When the rate is increased to .25 Gal/A. yield responses increased to +7 Bu/A. resulting in economic gains of +\$24.16/A.



### Composition Guarantee Analysis

<b>Total Nitrogen</b>	<b>7.00%</b> 7.00% Ammoniacal Nitrogen
<b>Sulfur (s)</b>	<b>8.70%</b> 8.70% Combined Sulfur
<b>Manganese (Mn)</b>	<b>0.07%</b> 0.07% Water Soluble Manganese (Mn)
<b>Zinc (Zn)</b>	<b>0.07%</b> 0.07% Water Soluble Zinc (Zn)

Figure 1. Conceal® Placement

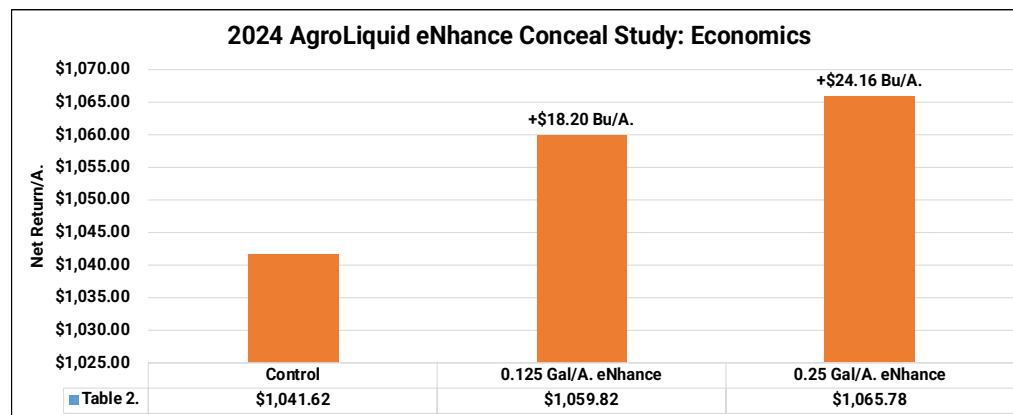
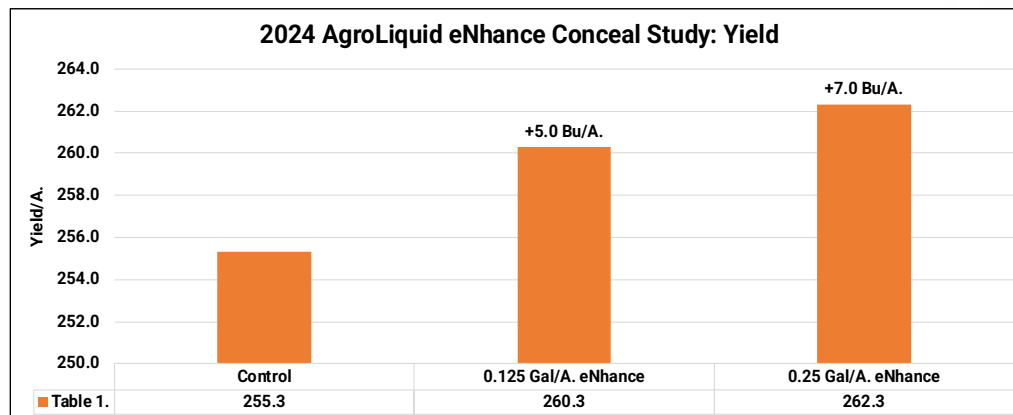

Planting Date: May 10<sup>th</sup> Hybrid: GH 12U11 Population: 36K Row Width: 30" Rotation: CAC Corn Price: \$4.08 eNhanCe: \$17.64/Gal

## Corn 2024 Summary of Conceal® Applications

Study	Classification	Yield (Bu/A.)	\$ROI
NewFields Ag Irrigated High Management Corn At- Plant	Starter Fertilizer/ Nitrogen	14.2	\$ 64.76
AgXplore Irrigated High Management Corn At- Plant	Starter Fertilizer/ Nitrogen	9.8	\$ 62.48
Corteva Irrigated High Management Corn At- Plant	Starter Fertilizer/ Nitrogen	8.1	\$ 61.49
NMS Irrigated High Management Corn At- Plant	Starter Fertilizer/ Nitrogen	8.1	\$ 61.49
Golden Harvest Genetics 38K Pop+ Planter N+ No Fungicide	Nitrogen	12.5	\$ 51.00
Xyway LFR	Fungicide	16	\$ 47.65
Marco Irrigated High Management Corn At- Plant	Starter Fertilizer/ Nitrogen	10.2	\$ 44.79
15" Narrow Row Corn Nitrogen Placement 50% Conceal 50% EZ Drop Side-Dress	Nitrogen	13.5	\$ 39.08
Golden Harvest Genetics 32K Pop+ Planter N+ No Fungicide	Nitrogen	9.1	\$ 37.26
15" Narrow Row Corn Nitrogen Placement 50% WNF 50% Conceal	Nitrogen	6.7	\$ 27.34
AgroLiquid eNhanse 0.25 Gal	Nitrogen Fertilizer	7	\$ 24.16
Aqua-Yield NanoN+ 4oz	Nitrogen Enhancer	5.8	\$ 19.28
AgroLiquid eNhanse 0.125 Gal	Nitrogen Fertilizer	5	\$ 18.20
May 6th Corn Plant Date with Starter	Starter Fertilizer	12.9	\$ 15.39
QLF Irrigated High Management Corn At- Plant	Starter Fertilizer/ Nitrogen	26.7	\$ 14.53
April 16th Corn Plant Date with Starter	Starter Fertilizer	12.6	\$ 13.76
Dual Band over Single Band Conceal	Nitrogen	2.8	\$ 11.26
QLF Dryland High Management Corn At- Plant	Starter Fertilizer/ Nitrogen	25.2	\$ 8.41
May 11th Corn Plant Date with Starter	Starter Fertilizer	9.1	\$ (0.52)
May 20th Corn Plant Date with Starter	Starter Fertilizer	2.5	\$ (27.86)
May 26th Corn Plant Date with Starter	Starter Fertilizer	1.2	\$ (32.76)
100% Green Lightning Replacement N	Nitrogen	-44.8	\$ (57.46)
Average		7.9	\$ 22.90



## Continuous Corn Cover Crop Study

**Objective:** This trial is designed to evaluate the yield and economic benefits of a cover crop system in a continuous corn rotation. To evaluate long-term benefits, this trial has been designed as a 10-year study. 20#/A. of an 80/20 blend of annual rye and radish was planted in the fall of 2023 and fall strip-till was used as the primary tillage system for corn. In the spring, corn was planted directly on the fall strips into the green cover crop. The cover crop was terminated at 6" in overall height.

**Results:** Continuous corn planted into our 4th year of our 10-yr study proved +2.3Bu/A. yield gains compared to a non-cover crop system. These gains resulted in an economic deficit of **-\$31.37/A.** due to the price of the seed, and application cost.

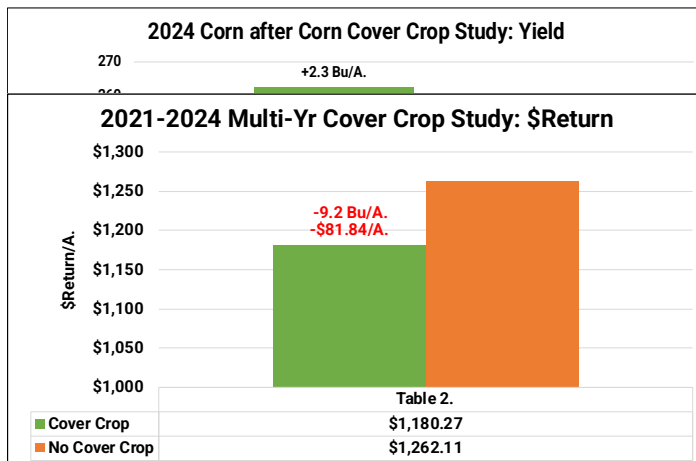

Figure 1. Fall Cover Crop Seeding



Figure 2. Continuous Corn in Cover Crop

Table 2. illustrates 4-yr data of cover crops in a continuous corn rotation. Over 2021-2024, the PTI Farm has experienced a **-9.2 Bu/A** yield deficit with economic losses of **-\$81.84/A.**

We look forward to continuing testing the use of cover crops to evaluate yield and economics of the system, while taking a close look at what cover crops can offer regarding soil health improvement. Being in our 4th year, we are hopeful yield, cash flow, and soil health will improve soon.

## Corn after Soybean Cover Crop Study: Dryland

**Objective:** This trial is designed to evaluate the yield and economic benefits of a cover crop system in a corn/soybean corn rotation. To evaluate long-term benefits, this trial has been designed as a 10-year study. An 80/20 blend of annual ryegrass and radish was planted in the fall of 2023 and fall strip-till was used as the primary tillage system for corn. In the spring, corn was planted directly on the fall strips into the green cover crop. The ryegrass was terminated when corn reached the V2 growth stage.

**Results:** Table 1. illustrates cover crops proved yield very similar to non-cover crop replications with only a difference of 1.0 Bu/A.

Table 2. summarizes multi-year data from 2021-2024, revealing net economic losses annually ranging from as minimal as **-\$0.51/A.** to as high as **-\$276.84/A.** Over the 4 year time span, cover crops have averaged losses of **-\$86.00/A.**

We look forward to continuing evaluating the use of cover crops in a corn/soybean rotation over the rest of the 10-yr time period. Our hopes are that the yield and economics of the system begin to improve, as the system has had 4yrs to start the transformation of overall healthier soils, less erosion, soil structure and increased soil biology.

Figure 1. Planting into Strip-Till with Green Cover

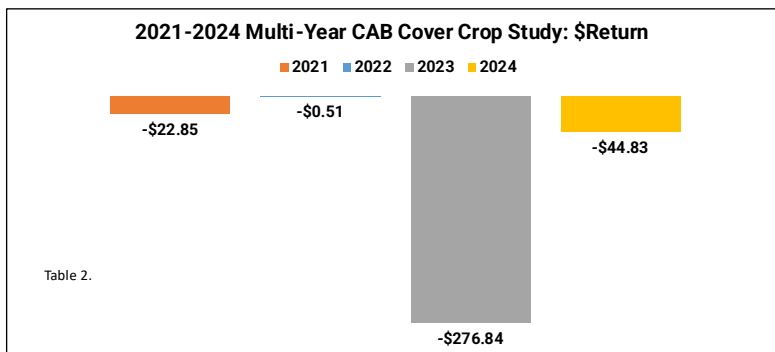
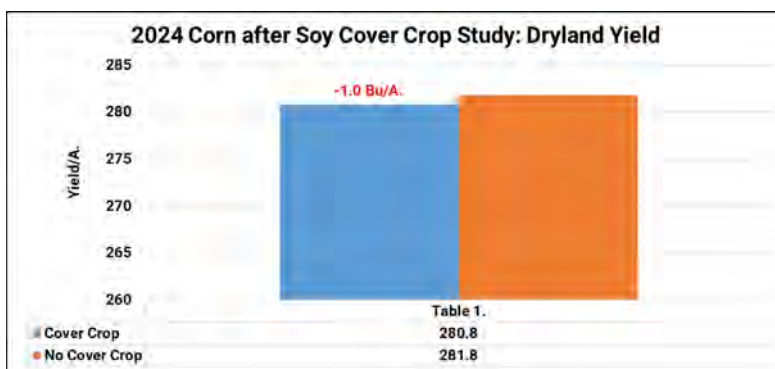

Planting Date: April 28<sup>th</sup>    Hybrid: DKC 66-06    Population: 36K    Row Width: 30"    Rotation: CAB    Corn Price: \$4.08    Seed: \$32.75 inc. \$8 drill cost

## 30" Solar Corridor Study

**Objective:** This trial's intention is to evaluate any yield or economic advantage in planting 30" row corn in a "solar corridor twin" method at seeding rates of 36K to 48K. A solar corridor is designed as 60" wide rows surrounded by two 30" rows. The theory behind this trial is to increase the distribution of sunlight so that all corn leaves or chloroplasts (regardless of their vertical disposition on the corn plant) receive full access to sunlight the entire growing season. If one of the basic principles of corn yield is maximizing sunlight, could a solar corridor ultimately contribute to increased yield?

**Results:** The solar corridor system this year resulted in terrible average yield losses of **-56.0 Bu/A.**, and economic losses of **-\$185.93/A.** compared to traditional 30" rows over all seeding rates. 60" solar corridor achieved highest agronomic and economic optimum yield at 48K seeding rates. The lowest seeding rates in the solar corridor got crushed yield wise with losses of **-64.4 Bu/A.** and economic losses of **-\$203.69/A.** As seeding rates went higher, yield losses were minimized but lost across the board. Multi-Year data has proven solar corridor largest economic losses at 36K seeding rates, however as seeding rate has climbed to 40K and 44K, economic gains have improved by **+\$47.11/A.** and **+\$73.57A.**



Figure 1. 60" Solar Corridor Corn System

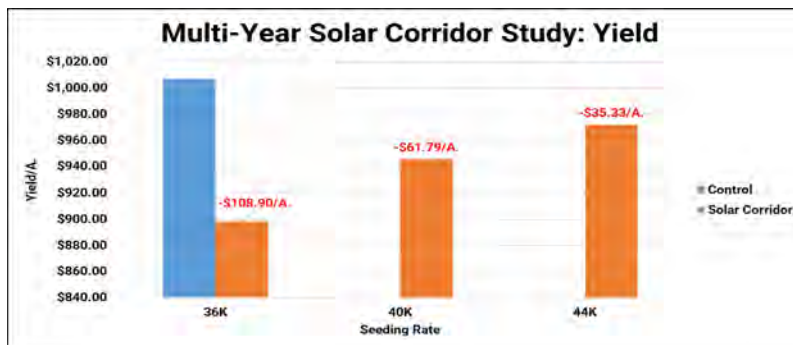
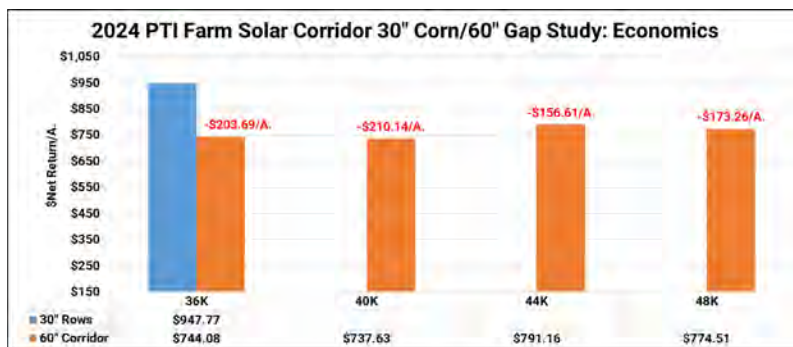
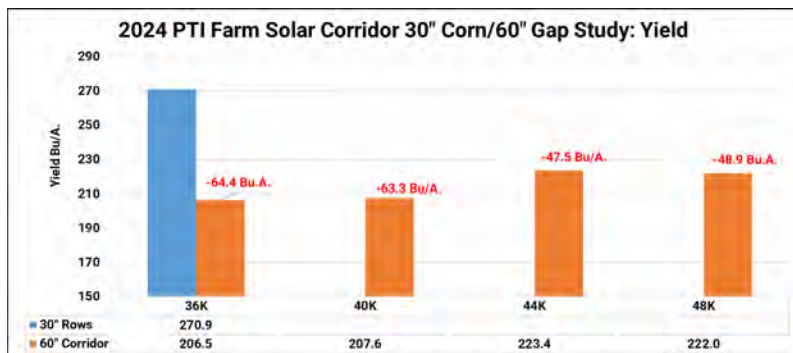

Planting Date: April 22<sup>nd</sup> Hybrid: GH 03U08 Population: 36K Row Width: 30" Rotation: CAB Corn Price: \$4.08 Seed: \$350/Bag, -37.5%

## Green Lightning™ Plasma Activated Water Nitrogen Foliar Study

**Objective:** To evaluate yield, net return, and nitrogen use efficiency (NUE) of Green Lightning plasma activated water as a foliar application to corn.

Green Lightning is a mechanism to replicate a naturally occurring process that leads to nitrogen. During a lightning storm, static electricity rearranges the nitrogen molecule in the air, and this modified molecule is contained within the rain. Green Lightning devices create lightning in a controlled environment under the same premise. Air and water are sent into a static electric field for the nitrogen molecule to go through a rearrangement process that allows attachment of the water present, flowing through the machine, and deposits an end product as NO<sub>2</sub> (nitrite) and NO<sub>3</sub> (nitrate).

A six head system called the THUNDER 365, produces nitrogen for 550 acres of corn annually. This system is designed for use by a farmer, in his/her own tool-shed, to make nitrogen by using only a 110v power, grounding rods, and a water supply.

This study compares the use of Green Lightning nitrogen as a 20 Gal/A. post foliar application at growth stage V6.

All nitrogen foliar applications were side-dressed with a Miller N-Place™ Max side-dress applicator (Figure 1).

The applicator is setup with dual band twin fan spray nozzles that sprays over, under and on the side of the leaf canopy, rather than traditional spray applications that only cover above the canopy.

Figure 1: Miller N-Place™ Max Side-Dress Toolbar





## Green Lightning™ Plasma Activated Water Nitrogen Foliar Study

**Results:** Tables 1-2. illustrate that foliar applications of Green Lightning plasma activated water resulted in yield gains of +3.2 Bu/A., with corresponding net return of +\$12.97/A.

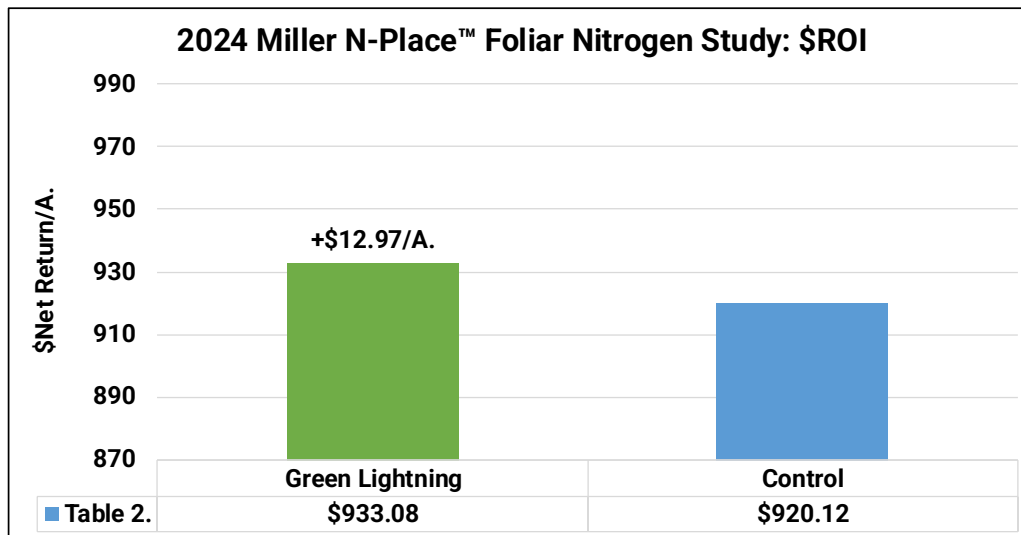
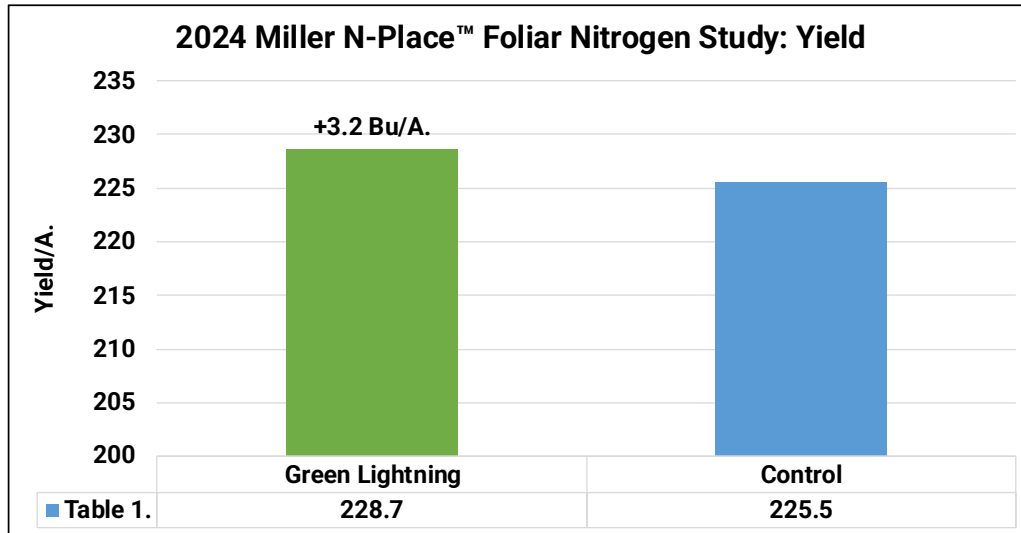

Planting Date: May 22<sup>nd</sup>    Hybrid: GH 15J91    Population: 34K    Row Width: 30"    Rotation: CAB    Corn Price: \$4.08    Green Lightning: \$0.04/Gal

## Corn Veltyma® Foliar Fungicide Study

**Objective:** To evaluate the yield and net return of Veltyma® fungicide.

Veltyma® contains Revysol®, which is a DeMethylation Inhibitor (DMI) fungicide that is part of the triazole group of fungicides initially labeled for 17 crops, including corn and soybeans. Veltyma® gives excellent control of anthracnose, eye spot, gray leaf spot, northern corn leaf blight, southern corn leaf blight, common rust, southern rust, and tar spot. Veltyma® has a label which expands the window of application from V10-R3.



**Active Ingredients\*:**  
 mefentrifluconazole: 2-[4-(4-chlorophenoxy)-2-(trifluoromethyl)phenyl]-1-(1H-1,2,4-triazole-1-yl)propan-2-ol ..... 17.56%  
 pyraclostrobin: (carbamic acid, [2-[[[1-(4-chlorophenyl)-1H-pyrazol-3-yl]oxy)methyl]phenyl]methoxy-, methyl ester) ..... 17.56%  
**Other Ingredients:** ..... 64.88%  
**Total:** ..... 100.00%  
 \* Veltyma™ fungicide contains 1.67 lbs mefentrifluconazole and 1.67 lbs pyraclostrobin per gallon.  
 EPA Reg. No. 7969-409 EPA Est. No.

Mefentrifluconazole	Group	3	Fungicide
Pyraclostrobin	Group	11	Fungicide

**Results:** Table 1. illustrates that VT foliar applications of Veltyma® resulted in yield gains of +12.3 Bu/A. at the VT growth stage and +14.2 Bu/A. when sprayed at a 2<sup>nd</sup> pass at R3. This plot had low levels of corn tar spot; however, it was easily found in this particular trial.

After cost of application and fungicide, using a \$4.08 corn price, Veltyma® proved positive net returns of +\$20.18/A. at VT. The 2<sup>nd</sup> pass R3 treatments resulted in yield gains over the untreated control and proved economic losses of **-\$2.06/A.** compared to stand-alone 1<sup>st</sup> pass VT treatments.

Figure 1. Tar Spot in Corn

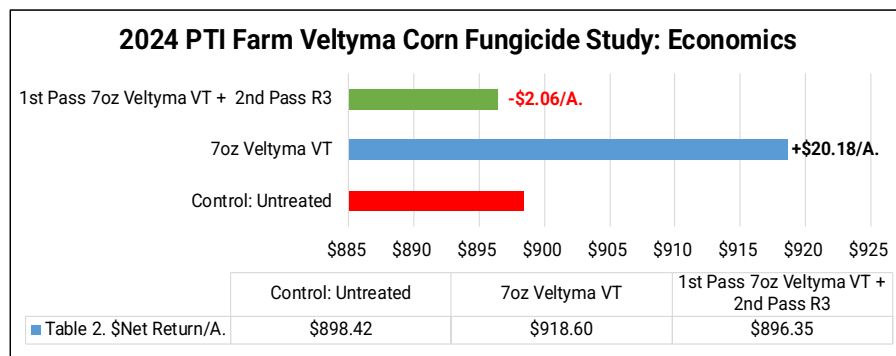
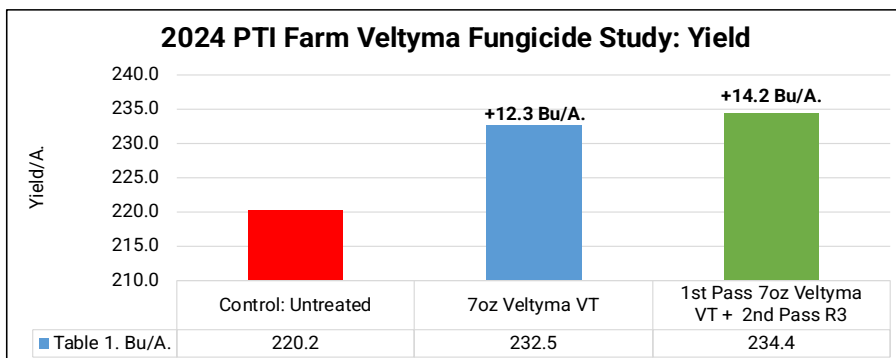

Planting Date: April 21<sup>st</sup> Hybrid: Becks 6374VT2P Pop: 36K Row Width: 30" Rotation: CAB Corn Price: \$4.08 Veltyma®+App: \$30/A.

## Adastrio™ Corn Foliar Fungicide Study

**Objective:** To evaluate the yield and net return of Adastrio™ fungicide. Adastrio™ contains flutriafol, which is a Group 3 highly systemic fungicide with translaminar activity that protects the sprayed leaf throughout growing season to help prevent additional disease from developing.

Adastrio™ fungicide provides long lasting residual protection in corn and protects against key diseases including anthracnose, cercospera leaf blight, frogeye leaf spot, rusts, leaf blights, powdery mildew, and tar spot.

**Results:** Table 1 illustrates that foliar applications of Adastrio™ resulted in a yield advantage of +10.7 Bu/A. when applied at V10, and +13.2 Bu/A. when applied at VT. Table 1 illustrates sequential treatments of fungicide proved yield advantages of +18.6 Bu/A.

Table 2. reveals the economics of all treatments. After the cost of application and fungicide, using a \$4.08 corn price, Adastrio™ proved economic returns of +\$11.77/A, and +\$21.97/A. on single applications.

Sequential V10/VT treatments resulted in economic gains of +\$12.12/A. after the cost of the product and application charge.

AZOXYSTROBIN	Group	11	Fungicide
FLUINDAPYR	Group	7	Fungicide
FLUTRIAFOL	Group	3	Fungicide



For use on corn (field corn, field corn grown for seed, popcorn and sweet corn), grain sorghum, wheat, triticale, and barley.

EPA Reg. No. 279-3642      EPA Est. 70815-GA-001

Azoxystrobin: methyl (E)-2-[2-[6-(2-cyanophenoxy)pyrimidin-4-yloxy]phenyl]-3-methoxyacrylate\* ..... 15.7%

Fluindapyr ..... 10.5%

Flutriafol ..... 15.7%

**OTHER INGREDIENTS:** ..... 58.1%

TOTAL: ..... 100.0%

Contains 1 pounds per gallon of the active ingredient fluindapyr, 1.5 pounds per gallon of the active ingredient flutriafol, and 1.5 pounds per gallon of the active ingredient azoxystrobin. Suspension Concentrate.

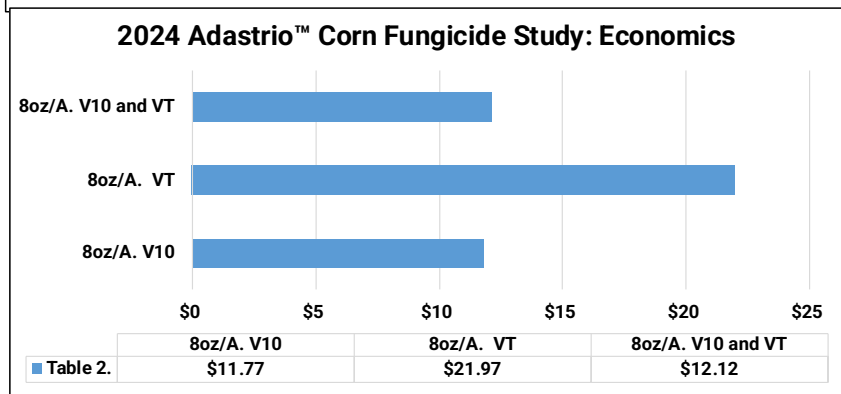
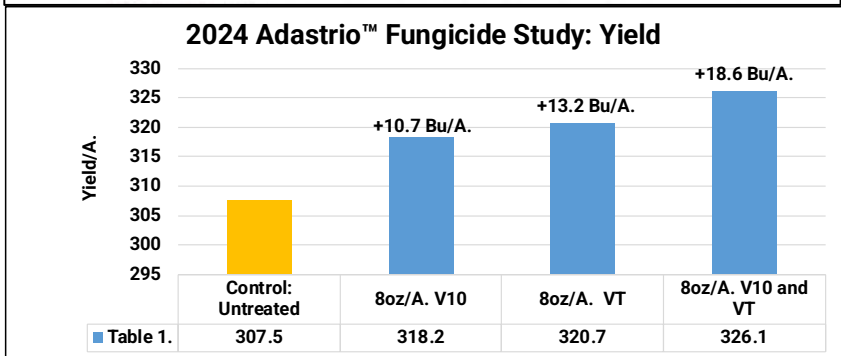

Planting Date: May 10<sup>th</sup>    Hybrid: DKC 6595    Pop: 36K    Row Width: 30"    Rotation: CAC    Corn Price: \$4.08    Adastrio™ + App: \$31.88/A.

## Miravis® Neo Corn Foliar Fungicide Study

**Objective:** To evaluate the yield and economics of a Miravis®Neo fungicide.

Miravis®Neo fungicide combines propiconazole, azoxystrobin and Adepidyn technology – one of the most powerful, broad spectrum SDHI molecules available, and delivers superior plant-health benefits and improved preventive and curative control of key diseases such as Gray Leaf Spot, Common and Southern Rust, Tar Spot, Eye Spot, Anthracnose, Diplodia Ear Rot, and Physoderma Brown Spot.

**Results:** Miravis®Neo treatments at VT growth stage proved yield gains of +12.1 Bu/A. with positive economic returns of +\$18.02/A.

A sequential treatment at R1 and again at R3, proved additional yield gains of +0.7 Bu/A. but offered **-\$10.48/A** negative return on investment over single VT treatments.

Multi-year data from 2021-2024 growing seasons, over those 4 years Miravis®Neo has proved economic advantages of +\$19.95 when applied at VT, and +\$6.78/A. when sequentially applied at VT+R1.



ADEPIDYN® Technology\*

Active Ingredients:

Pydiflumetofen**	PYDIFLUMETOFEN	GROUP 7	FUNGICIDE	7.0%
Azoxystrobin***	PROPICONAZOLE	GROUP 3	FUNGICIDE	9.3%
Propiconazole****	AZOXYSTROBIN	GROUP 11	FUNGICIDE	11.6%
Other Ingredients:				72.1%
Total:				100.0%

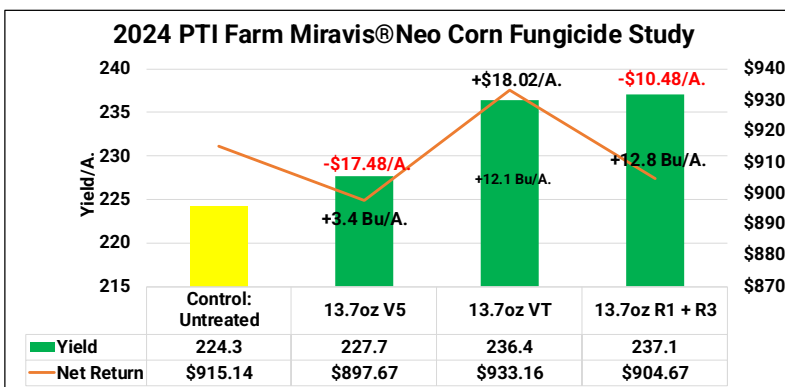

Planting Date: April 27<sup>th</sup> Hybrid: DK 66-06 Population: 36K Row Width: 30" Rotation: CAB Corn Price: \$4.08 Miravis®Neo + App: \$31.35/A.

## Fungicide Ground vs. UAV Foliar Spray Application Study

**Objective:** To evaluate the yield and net return of Veltyma® fungicide applied at VT growth stage.

This study evaluates a traditional ground fungicide application with a Hagie® high-clearance sprayer, at a carrier rate of 20 Gal/A. Additionally, the use of a DJI™ AGRAS T40 spray UAV (Unmanned Ag Vehicle) was also evaluated at carrier rates of 3 Gal/A. (Figure 1).

Veltyma fungicide was designed to help you get every bushel you deserve. It contains a unique active ingredient, Revysol®, the first and only isopropanol azole. Revysol fungicide delivers broader, stronger, longer disease control.

# Veltyma®

**Active Ingredients\*:**

mefentrifluconazole: 2-[4-(4-chlorophenoxy)-2-(trifluoromethyl)phenyl]-1-(1H-1,2,4-triazole-1-yl)propan-2-ol	17.56%
pyraclostrobin: (carbamic acid, [2-[[[1-(4-chlorophenyl)-1H-pyrazol-3-yl]oxy]methyl]phenyl]methoxy-, methyl ester)	17.56%
<b>Other Ingredients:</b>	<b>64.88%</b>
<b>Total:</b>	<b>100.00%</b>



Figure 2. DJI™ AGRAS T40 UAV



## Fungicide Ground vs. UAV Spray Application Study Continued

**Results:** Table 1. illustrates that VT foliar applications of Trivapro® resulted in yield gains of +10.1 to +12.8 Bu/A. The Hagie® high clearance sprayer and the T40 spray UAV yielding resulted in similar performance, with the UAV tallying higher yields of +2.7 Bu/A. and +\$11.02/A. additional return.

In our 4th year of evaluating spray UAV applications, it does appear that this technology is an effective method to apply crop protection products, in regard to control. In 2021, the spray UAV applications resulted in +4.5 Bu/A. yield gains with additional revenue of +\$22.50/A. and 2022 offered +1.3 Bu/A. yield gains and +\$7.20/A. additional revenue. (4-yr avg= +2.6 Bu/A., +\$12.05/A.)

Advantages to UAV technology include precise application due to downward propeller air movement, low carrier rates, the absence of ground or soil engagement, and the ability to spray in fields with topography challenges. Disadvantages include flight time duration, tank capacity, battery charge, and insurance/licensing. UAV supplied by Green Creek Drones located in Effingham, Illinois.

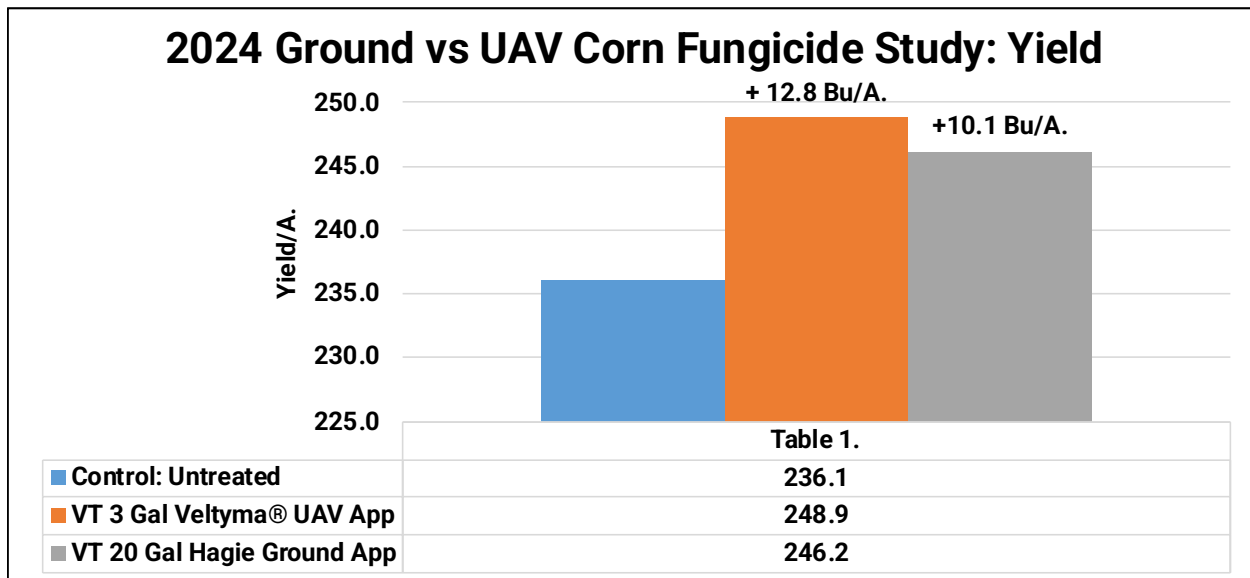

Date: April 25<sup>th</sup>    Hybrid: DKC 66-06VT2Pro    Pop: 36K    Row Width: 30"    Rotation: CAB    Corn Price: \$4.08

Ground Application: Turbo TwinJet Twin Flats 11005, 80# PSI 20 Gal/A.    UAV Application: 3 Gal/A.

## Fungicide Ground vs. UAV Foliar Spray Application Study

**Objective:** To evaluate the yield and net return of Veltyma® fungicide applied at VT growth stage.

This study evaluates a traditional ground fungicide application with a Hagie® high-clearance sprayer, at a carrier rate of 20 Gal/A. Additionally, the use of a DJI™ AGRAS T50 spray UAV (Unmanned Ag Vehicle) was also evaluated at carrier rates of 3 Gal/A. (Figure 1).

Miravis®Neo fungicide combines propiconazole, azoxystrobin and Adepidyn technology – one of the most powerful, broad spectrum SDHI molecules available, and delivers superior plant-health benefits and improved preventive and curative control of key diseases such as Gray Leaf Spot, Common and Southern Rust, Tar Spot, Eye Spot, Anthracnose, Diplodia Ear Rot, and Physoderma Brown Spot.



PYDIFLUMETOFEN	GROUP	7	FUNGICIDE
PROPICONAZOLE	GROUP	3	FUNGICIDE
AZOXYSTROBIN	GROUP	11	FUNGICIDE

<i>Active Ingredients:</i>	
Pydiflumetofen**	7.0%
Azoxystrobin***	9.3%
Propiconazole****	11.6%
<i>Other Ingredients:</i>	72.1%
<i>Total:</i>	100.0%



Figure 2. DJI™ AGRAS T50 UAV



## Fungicide Ground vs. UAV Spray Application Study Continued

**Results:** Table 1. illustrates that VT foliar applications of Miravis®Neo resulted in yield gains of +11.4 to +13.2 Bu/A. The Hagie® high clearance sprayer and the T50 spray UAV yielding resulted in similar performance, with the UAV tallying higher yields of +1.8 Bu/A. and +\$7.34/A. additional return.

In our 4th year of evaluating spray UAV applications, it does appear that this technology is an effective method to apply crop protection products, in regard to control. In 2021, the spray UAV applications resulted in +4.5 Bu/A. yield gains with additional revenue of +\$22.50/A. and 2022 offered +1.3 Bu/A. yield gains and +\$7.20/A. additional revenue. (4-yr avg= +2.6 Bu/A., +\$12.05/A.)

Advantages to UAV technology include precise application due to downward propeller air movement, low carrier rates, the absence of ground or soil engagement, and the ability to spray in fields with topography challenges. Disadvantages include flight time duration, tank capacity, battery charge, and insurance/licensing. UAV supplied by Truss Services LLS. located in Bucyrus, OH.

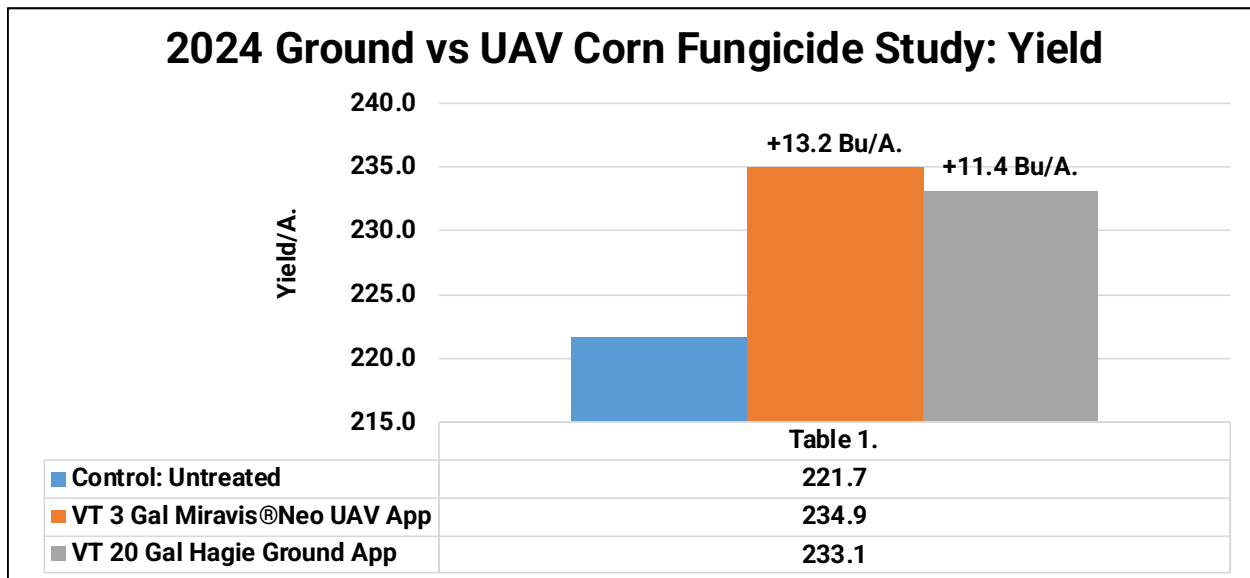

Date: April 25<sup>th</sup>    Hybrid: DKC 66-06 Trecepta    Pop: 36K    Row Width: 30"    Rotation: CAB    Corn Price: \$4.08

Ground Application: Turbo TwinJet Twin Flats 11005, 80# PSI 20 Gal/A.    UAV Application: 3 Gal/A.



## Aqua-Yield® NanoK® Foliar Potassium Study

**Objective:** To evaluate yield and economics of NanoK® by AQUA-YIELD. NanoK® delivers potassium acetate through Aqua-Yield nano liquid technology. Potassium is a vital nutrient for plant growth, and NanoK® ensures a strong plant structure resulting in enhanced crop quality and yield. NanoK also decreases drought stress and boosts the plant's immune system to fight off disease.

This trial aims to establish the efficiency of Aqua-Yield's NanoK® as a foliar based application of 4oz/A. at the V5 growth stage.

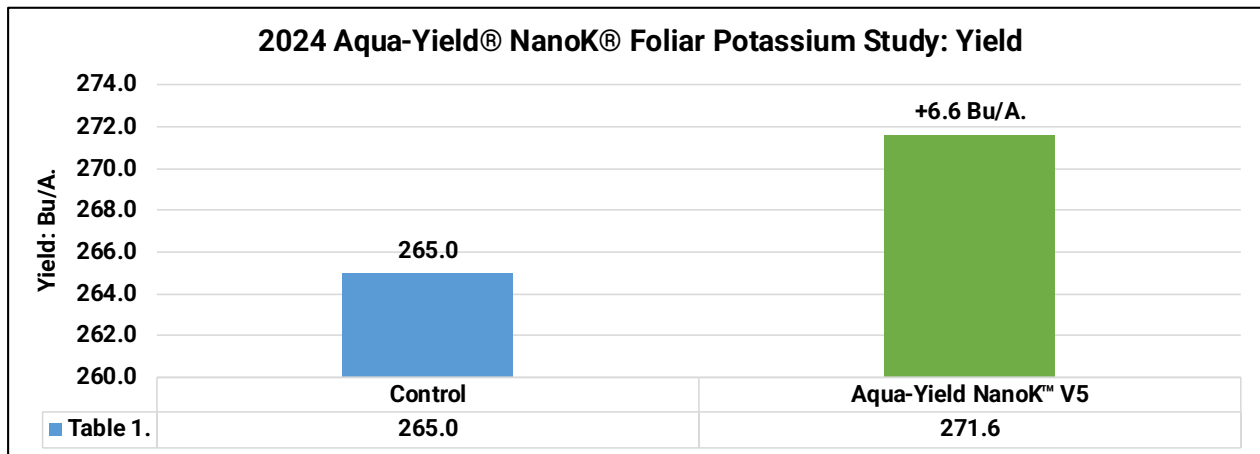

AQUA-YIELD®

**NanoK®**

## Aqua-Yield® NanoK® Foliar Potassium Study Continued

**Results:** Table 1. illustrates yield results of all treatments. Aqua-Yield’s NanoK® resulted in +6.6 Bu/A. yield improvement over the control.

Table 2. summarizes the overall economics of the foliar fertility study where NanoK® resulted in positive economic gains of +\$19.74/A.

Figure 1. below is a recent soil test from the PTI Farm. Base saturation K levels indicate low levels of 2.0 to 2.8%, when nearer to 4% would be optimum. This may help explain as to the reason for the nice response of NanoK®. Potassium continues to be a concern and goal/challenge to correct at the PTI Farm.

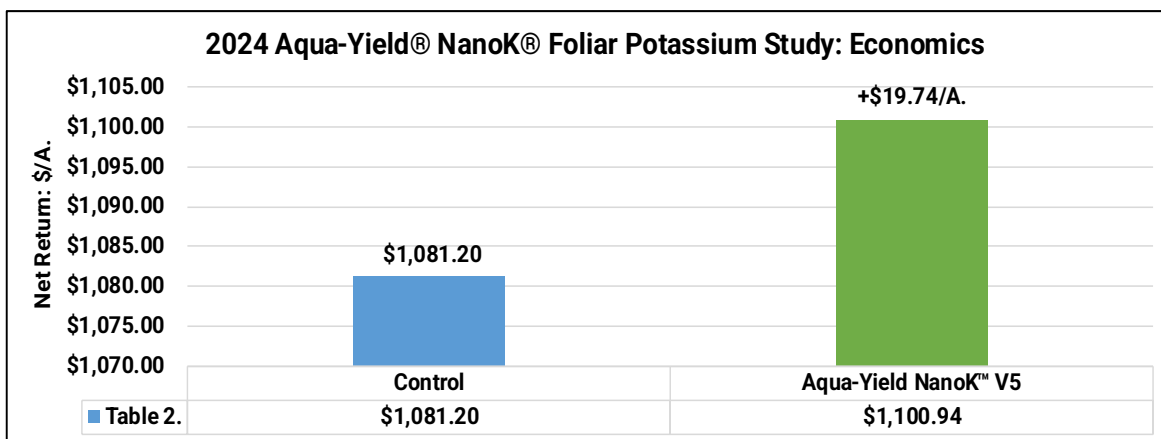

Figure 1: Soil Test Results at PTI Farm

SOIL ANALYSIS REPORT																		
ORGANIC MATTER L.O.L.	PHOSPHORUS				NEUTRAL AMMONIUM ACETATE (EXCHANGEABLE)				pH		CATION EXCHANGE CAPACITY C.E.C. meq/100g	PERCENT BASE SATURATION (COMPUTED)						
	P <sub>1</sub> (WEAK BRAY) 1:7		P <sub>2</sub> (STRONG BRAY) 1:7		K		Mg		Ca			SOIL pH 1:1	BUFFER INDEX	% K	% Mg	% Ca	% H	% Na
	percent	RATE	ppm	RATE	ppm	RATE	ppm	RATE	ppm	RATE				ppm	RATE	meq/100g		
4.9 VH	35 VH	66 VH			228 M	601 VH	4179 H	10	6.3	6.6	29.6	2.0	16.9	70.6	10.4	0.1		
3.5 M	33 VH	54 H			168 M	309 VH	3008 H	9	6.1	6.6	21.0	2.1	12.3	71.6	13.8	0.2		
4.1 H	38 VH	68 VH			258 VH	372 VH	3528 H	9	6.3	6.7	23.9	2.8	13.0	73.8	10.2	0.2		

Planting Date: May 11<sup>th</sup>    Hybrid: GH 15J91    Population: 36K    Row Width: 30"    Rotation: CAB    Corn Price: \$4.08    NanoK®: \$7.06/A.

## Aqua-Yield® NanoPro® Foliar Fungicide Study

**Objective:** To evaluate yield and economics of NanoPro® by AQUA-YIELD®. NanoPro® is a carrier adjuvant that enhances the uptake of crop protection products.

This trial aims to establish the efficiency of Aqua-Yield's NanoPro® as a tank-mix partner with a corn fungicide applied at the VT growth stage (13.7oz/A. Miravis® Neo).



**Results:** Table 1. illustrates Aqua-Yield's NanoPro® resulted in +2.6 Bu/A. yield improvement over the control of a standard fungicide application at VT growth stage.

With a +2.6 Bu/A. yield response, economics would suggest that NanoPro® resulted in positive economic gains of +\$7.16/A.

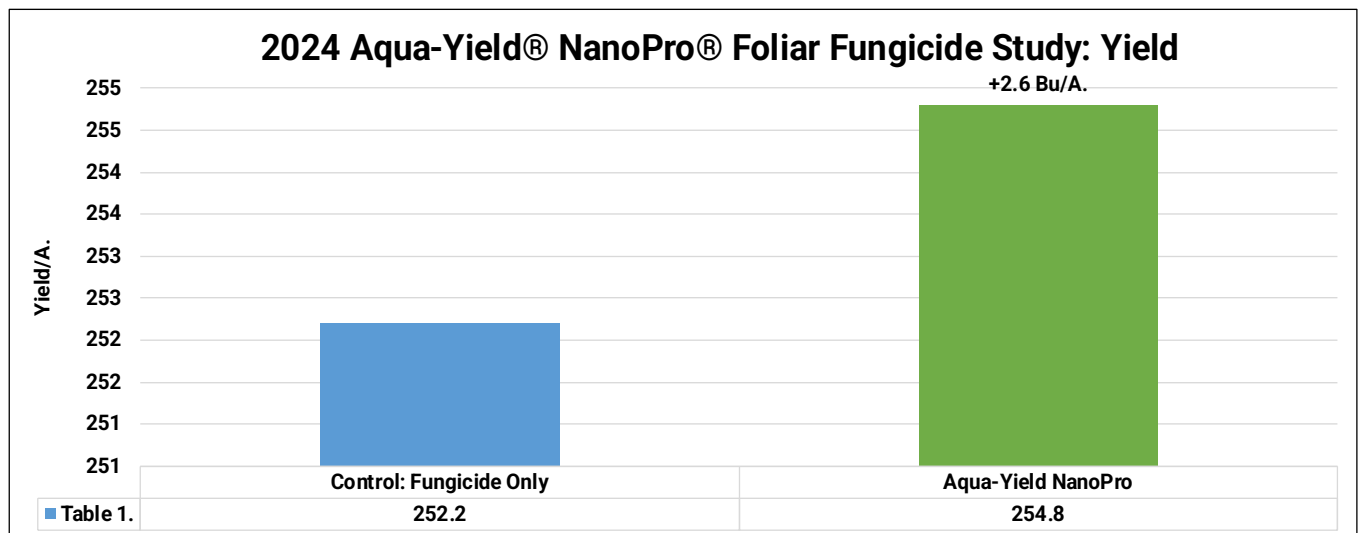

Planting Date: May 11<sup>th</sup>    Hybrid: GH 15J91    Population: 36K    Row Width: 30"    Rotation: CAB    Corn Price: \$4.08    NanoPro®: \$3.28/A.

## Chopping Corn Head Study

**Objective:** To study the yield impact of utilizing a chopping corn head in a continuous corn conventional tillage rotation. A Capello DIAMANT™ chopping head is used to create replicated strips of chop and non-chop residue management trials. The goal of this trial is to evaluate sizing of residue, allowing heavy stalks and residue to break down faster to advance the degradation process and in turn, reducing the carbon penalty associated with continuous corn environment.

**Results:** Table 1. illustrates that chopping corn residue improved corn yields by +7.5 Bu/A. and increased gross revenue by +\$30.60/A.

Multi-year data from 2017-2024 has indicated consistent results with chopping advantages of +5.5 to +11.1 Bu/A.

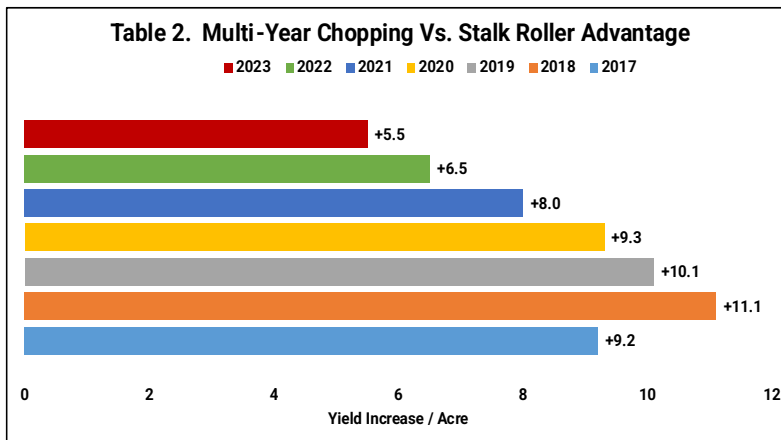
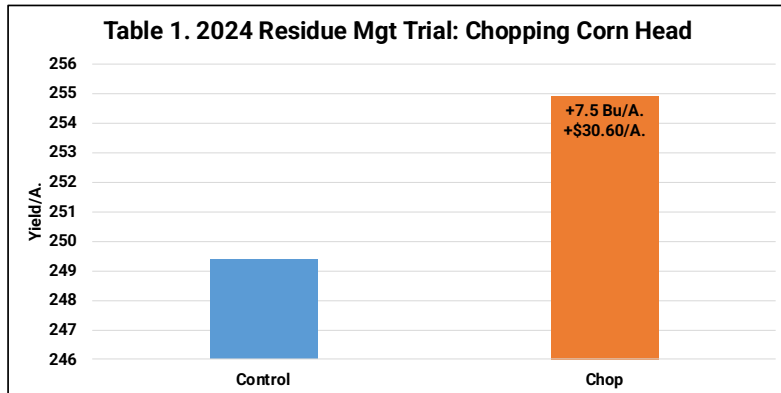

Planting Date: May 13<sup>th</sup>    Hybrid: DKC 66-06Trecepta    Population: 36.5K    Row Width: 30"    Rotation: CAC    Corn Price: \$4.08

## Phantom Yield Loss Study:

**Objective:** To evaluate yield and economics of harvesting multiple corn hybrids at earlier and later harvest intervals of 26%, 24%, 19% and 14% grain moisture levels. The goal of this study is to determine if higher moisture grain at harvest offers higher yields and if so, is there a “phantom” yield loss that occurs when corn harvest occurs at lower grain moistures?

Many times at the PTI Farm, corn harvest gets delayed due to weather or even switching crops to harvest soybeans. It is not common during this moisture transition in corn to observe lower actual yield when corn harvest begins again at lower moisture grain levels. This phenomenon is called by many farmers as “invisible” or “phantom” yield loss.

Why does corn potentially yield less as grain moisture levels decrease naturally in the field? The following are factors that could contribute to phantom yield losses:

<i>*Wind Damage and/or Stalk Lodging</i>	<i>*Dry Matter Loss from Respiration</i>
<i>*Ear Rots Leading to Kernel Damage</i>	<i>*Insect Damage Leading to Kernel Damage</i>
<i>*Increased Butt Shelling at Corn Head</i>	<i>*Increased Fines, Cracked Dry Kernels</i>

**Results:** In 2024, Phantom or Invisible yield loss resulted in a real tangible loss. Five corn hybrids were used in this study including Wyffels 6886VT2P, DeKalb 66-06Trecepta, DeKalb 61-40 SmartStax, Dekalb 111-35VT4Pro, and DeKalb 56-26Trecepta. Each hybrid was harvested at

average grain moisture levels of 26%, 24.3%, 19% and 14.2%. At 26% moisture, average yield resulted in 269.3 Bu/A. Table 1. illustrates average yield loss at each moisture level under the 26% base-line. As moisture declined, corn yield decreased by **-5.4**

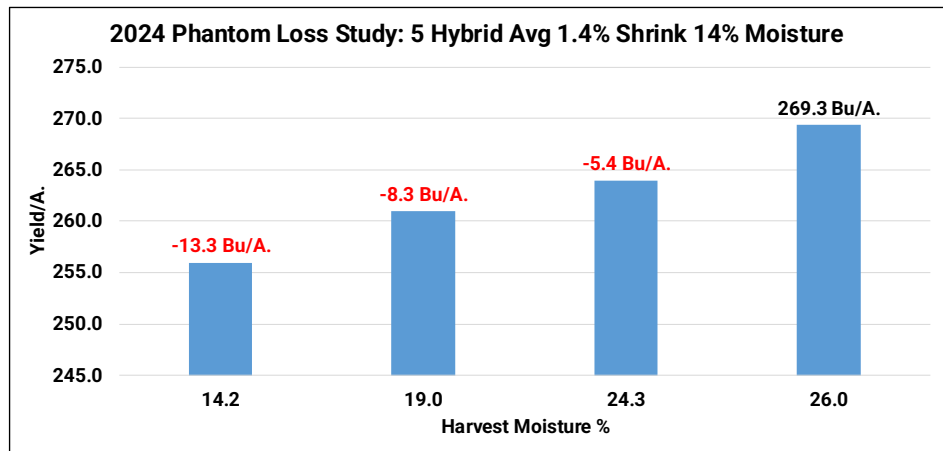

**Bu/A.** at 24.3%, **-8.3 Bu/A.** at 19%, and **-13.3 Bu/A.** at 14.2%.

## On-Farm vs Commercial Drying Study

**Objective:** To evaluate yield and economics of harvesting multiple corn hybrids at earlier and later harvest intervals of 26%, 24.3%, 19% and 14.2% grain moisture levels. This study will determine the most economical grain harvest moisture, comparing on-farm drying, versus a grower taking their grain to a commercial grain terminal.

The PTI Farm partnered with GSI Grain Systems on the construction of a new 70,000 grain storage facility with a GSI Q214 continuous flow dryer (Figure 1) in 2023. This facility is used to dry and store corn from grain harvest at the PTI Farm.

Figure 1. GSI Grain Storage Facility with Q214 Quiet Dryer™



## On-Farm vs Commercial Drying Study

Figure 1. illustrates cost of drying corn at a local grain terminal that the PTI Farm delivers grain to each harvest. Commercial shrink is calculated at 1.4% at 14% grain moisture.

For on-farm drying with the GSI Q214 continuous flow dryer, using propane gas, drying charges averaged \$0.019/moisture point/bushel. For example if grain was harvested at 26%, eleven points of moisture was removed to 15% #2 corn. The on-farm cost of this grain drying with liquid propane gas and electricity tallied \$0.209/Bu., reducing commercial drying charges by -39.4%. On-farm calculations use 1.2% shrink at 15% moisture.

**Figure 1. Commercial Grain Drying Rates:**

26%:	\$0.345/Bu.	All Calculated at 1.4% Shrink down to 14% Moisture
24.3%:	\$0.3225/Bu.	
19%:	\$0.18/Bu.	
14.2%:	\$0.00/Bu.	

**Results:** Table 1. illustrates average net return for all harvest moistures in a commercial cost, grain elevator delivery at harvest. 14.2% moisture corn realized highest overall net return for the 5 corn hybrids. Higher in-field moistures of 19% resulted in losses of **-\$26.45/A.** As corn harvest moisture increased to 24.3%, higher net return losses of **-\$52.68/A.** were realized. Finally, 26% harvest moistures resulted in economic deficit of **-\$38.32/A.**

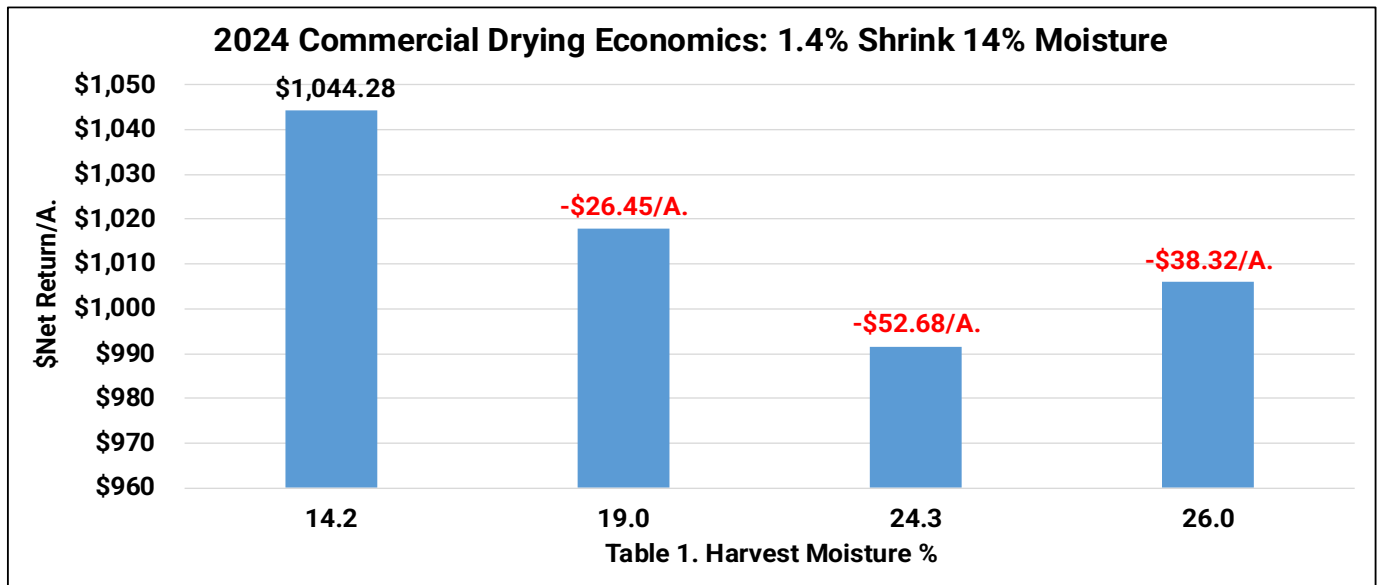

## On-Farm vs Commercial Drying Study

Table 2. illustrates average net return for all harvest moistures dried on-farm with the GSI drying system at harvest. In this scenario, the results are completely inverted from the commercial grain drying economics. On-farm drying resulted in 26% moisture corn realizing highest overall net return for the 5 corn hybrids. As corn hybrids we allowed to naturally dry down in the field, net economic losses occurred. 24.3% corn proved losses of **-\$15.09/A.**, 19% at **-\$12.65/A.** and 14.2% at **-\$33.63/A.**

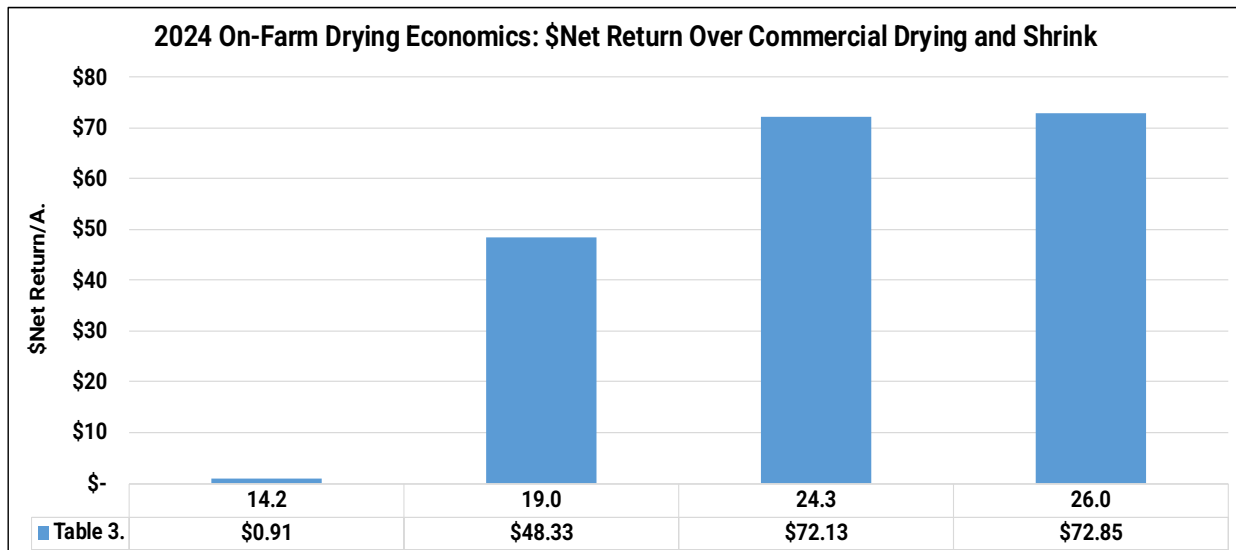
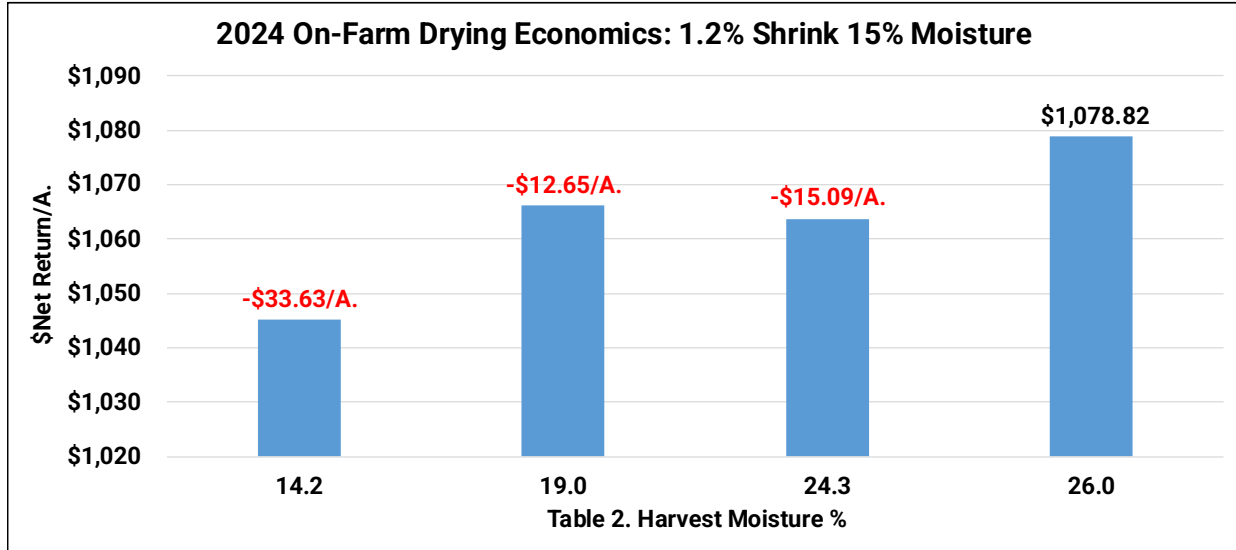

Table 3. reveals the economic advantage of the on-farm drying system compared to commercial grain drying and shrink charges. On-farm drying resulted in savings of +\$72/A. compared to commercial costs, +\$48/A. at 19% and +\$0.91/A. at 14.2 %.



## On-Farm vs Commercial Drying Study

In summary, in our second year of testing our new GSI Systems grain drying facility, we did uncover economic advantages for drying corn on-farm compared to commercial grain terminal with savings totaling near +\$72/A. in additional revenue and/or savings of expense.

Two additional points of interest are the following:

- ✓ **Advantage of 24Hr Grain Delivery:**  
Although it is unknown how to place a numerical dollar value at this point at this time, but efficiency of harvest was clearly improved. The fact that harvest could continue after dark did speed harvest up. When grain terminals close up shop at the end of day, our grain drying and storage system continued to be “open” which kept combines rolling and allowed for other activities such as tillage and cover crop planting to happen faster as well.



- ✓ **Patronage Dividends:** Patronage dividends are distributions of profits paid by a cooperative to growers. Patronage dividends are paid based on a portion of the profit the business makes. The exact dividend each member receives is based on how much they used the co-op's services or how much in products they purchased. In this case, proceeds for grain drying need to be factored into this feasible study where growers would have access to potential patronage. For example, the local cooperative near the PTI Farm has paid patronage on drying expenses averaging 22.38% annually over the past 6 years. Using the same factors discussed in this study, a patronage dividend of \$7.18/A. would be paid to the grower. This dividend would then bring total savings of the grain storage facility to +\$64/A.

Planting Date: May 20<sup>th</sup> Hybrid: DKC 61-40SS, 111-35TRE, 66-06VT2P, and GH 02K39 Population: 36K Row Width: 30" Rotation: CAC Corn Price: \$4.08

Propane: \$1.69/Gal Shrink: Commercial 1.4% at 14% Moisture, On Farm 1.2% at 15% Moisture

## Corn Tillage Study

**Objective:** To evaluate the yield and economic impacts of various tillage programs in a corn after soybean rotation. Tillage programs include conventional till, strip-till, vertical till, no-till and in-line rip.

Figure 1. KUHN® Krause® Gladiator®



Figure 2. Sunflower® 4630 Disc Ripper



## Corn Tillage Study Continued

Figure 6. Univ. of IL Machinery Cost Estimates

Tillage Practice	Category	Cost
Conventional Till	Ripper	\$36.40
	Soil Finisher	\$14.60
	Plant	\$21.40
	Total:	\$72.40
Strip Till	Strip	\$25.90
	Burndown	\$10.00
	Plant	\$21.40
	Total:	\$57.30
Vertical Till	Vertical	\$17.60
	Burndown	\$10.00
	Plant	\$21.40
	Total:	\$49.00
No Till	Plant	\$21.40
	Burndown	\$10.00
	Total:	\$31.40
In-Line Ripper	V-Ripper	\$33.70
	Soil Finisher	\$14.60
	Plant	\$21.40
	Total:	\$69.70

Figure 3. Planting in No-Till



Figure 4. Kuhn® EXCELERATOR® XT 8010 Vertical Tillage



Figure 5. Sunflower® 4608 In-Line Ripper



## Corn Tillage Study Continued

**Results:** To understand both yield and economics, the University of Illinois Machinery Cost Estimate Summary is used to calculate individual cost of each tillage program (Figure 6). For the three reduced tillage programs, an \$10/A. burn-down is also included.

Table 1. illustrates the overall yield for each tillage segment. Yield varied only **-9.1 Bu/A.** between all tillage programs. This is the first year at the PTI Farm where all tillage yield ended at par. Strip-Till offered highest yields at 277.1 Bu/A., while No till the lowest at 268 Bu/A. This may be contributed to the unusual hot and dry June experienced this spring burning high amounts of soil moisture.

After applying all appropriate costs to each individual tillage segment, conventional Till offered the highest overall revenue in this tillage system study in 2024. Compared to Strip-Till, Conventional tillage offered losses of **-\$43.90/A.**, vertical tillage **-\$25.98/A.**, and finally No-Till at **-\$11.20/A.** (Table 2).

Table 3. illustrates multi-year data from the PTI Farm in 2018-2023. Strip-till over this time frame has provided the highest overall net returns, with conventional till behind by **-\$17.04/A.** Vertical and no-till have resulted in losses of **-\$20.50** and **-\$25.13/A.** respectively.

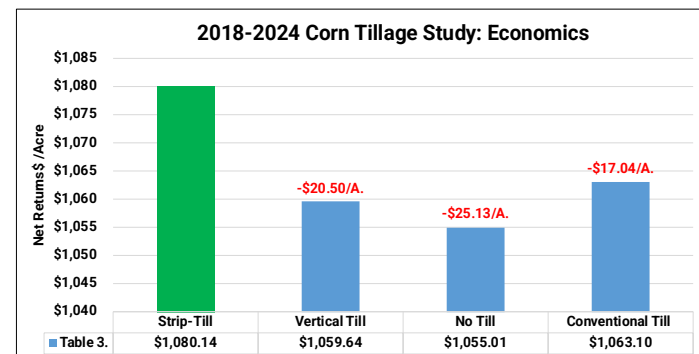
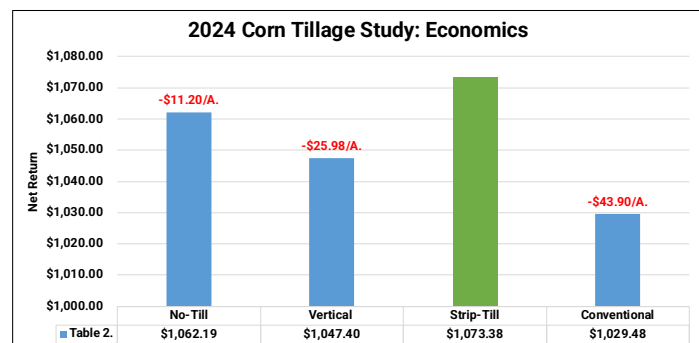
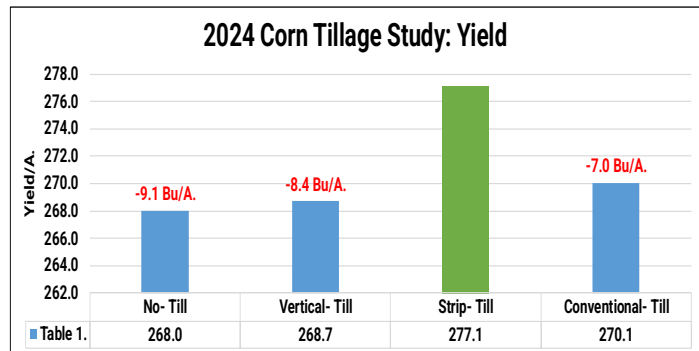

Planting Date: May 13<sup>th</sup>

Hybrid: DKC Wyffels 6886VT2P

Population: 36K

Row Width: 30"

Rotation: CAB

Corn Price: \$4.08

## Strip Freshener Study

**Objective:** To evaluate spring strip freshening to facilitate consistent soil warming and bring existing strips to life. Original fall strips made in October after harvest were freshened in April before planting using a Vulcan Equipment ZoneMaster.

**Features:**

- ZoneMaster uses parallel linkages to the row unit allowing it to conform to irregularities in the ground, and to increase flexibility, which results in accurate individual row unit depth control.
- Adjustable rolling baskets act as gauge wheels to keep the coulters at the desired depth. The ZoneMaster also has adjustable air bags that make optimizing down-pressure quick and easy.
- Operates at 6 to 10 mph and 1 1/2" to 4" deep, depending on depth setting.
- Precision Planting CleanSweep® residue managers to clean rows while building strip.

Figure 1. Vulcan ZoneMaster Strip



## Strip Freshener Study

**Results:** Table 1. illustrates Spring strip freshening in 2024 increased average yield by +4.7 Bu/A. This table also summarizes 7-yr (2018-2024) multi-year data showing positive yield gains from freshening every year. Average multi-yr yield response is +4.8 Bu/A., with yield ranging from +1.2 to +10.3 Bu/A.

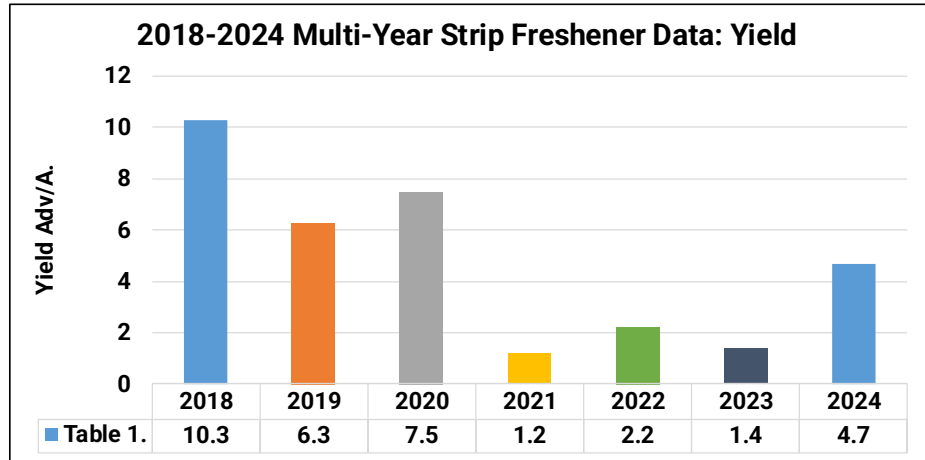
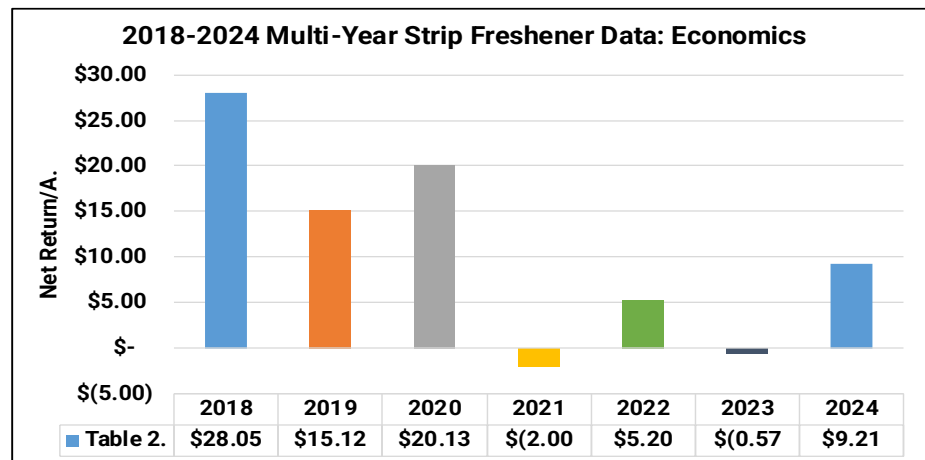

Table 2. illustrates net return on investment over the same time frame. 2024 strip freshening resulted in net positive gains of +\$9.21/A.



Multi-yr data has resulted in average net economic gains of +\$10.73/A., using a custom cost of \$10/A. for calculating

application charge. Of the 7 years in testing, 5 years have proven profitable, giving a 71% win rate. It should be noted that 2024 performance was impacted by 125% of normal rainfall during the month of April, causing planting to be temporarily delayed. Strip freshening opened the strips, allowing for warmer, drier soils which led to faster and more uniform stand establishment.

In general, with growers who strip-till, we advise them to have three scenarios to keep in mind. Our first and best option is to Fall strip-till and not have to make another trip to eliminate traffic and expense. Our second option is to freshen the strips if they didn't make thru the Winter months well. Lastly, if a strip freshener cannot fix or repair the strip, be prepared to tear it up and start over again with field cultivation, but plant in the same strip area if nutrient banding occurred.

## Pre-Plant Strip Freshening Nitrogen Application Study

**Objective:** To evaluate pre-plant spring strip freshening to facilitate applying 32% UAN nitrogen with the strip freshener, compared to applying nitrogen on the planter. Original fall strips made in October after harvest were freshened while applying nitrogen in April before planting.

This study will compare the strip freshener applied nitrogen to that of nitrogen applied on the planter to that of broadcast (non-banded) applied N.

Strip freshener nitrogen was applied at 20 Gal/A. and tendered using a Yetter 1600 gallon all wheel steer pup tank.

This bar was fitted with Pump Stack® (Figure 1.), a liquid fertilizer hydraulic pump. It was paired with EMHD® and EM FlowSense™ (Figure 2.) to ensure a top-notch fertilizer application, as well as row control across the bar. EMHD® controls liquid application rates using an electromagnetic flow meter. This opens your options for a wider range of liquid products. EM FlowSense™ allows you to measure the rate of fertilizer you are applying on each row of the bar, to make you aware of any row-to-row variability that is occurring. With a Pump Stack® system, paired with EMHD®, and EM FlowSense™ you can be confident in your application rate across every row.

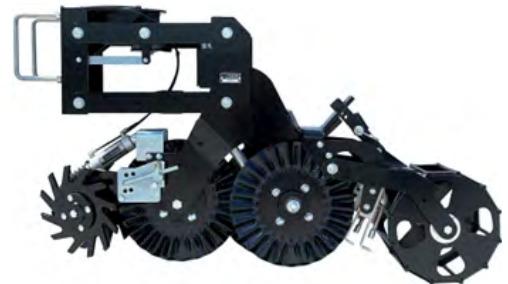

Figure 1. Pump Stack®



Figure 2. EMHD® + EM FlowSense™



## Pre-Plant Strip Freshening Nitrogen Application Study

The at-plant nitrogen was applied on the planter with a Conceal® dual band application. A Conceal® system is a unique planter attachment that allows growers to place nitrogen in a high concentration dual or single band positioned 3" away from the seed trench (Figure 1.) in depths near 1.5". If corn is planted at a 2" depth, Conceal® system fertilizer placement is 3X-0.5X2.

Conceal® uses existing planter space, utilizing a backswept knife located within the center of the planter's gauge wheels (Figure 1). As nitrogen is applied, it is sealed within the soil profile, preventing potential volatilization losses typically seen with surface type nitrogen applications.



Figure 3. Conceal Dual Placement 3" from Seed





## Pre-Plant Strip Freshening Nitrogen Application Study

**Results:** Table 1. illustrates both the Conceal and the strip freshened applied nitrogen proved +6.4 to +9.0 Bu/A. higher yields than non-banded broadcast applied nitrogen. Both performed well, but we are suspicious of freshened N to have more of an incorporated application, rather than a true concentrated band on each side of the furrow.

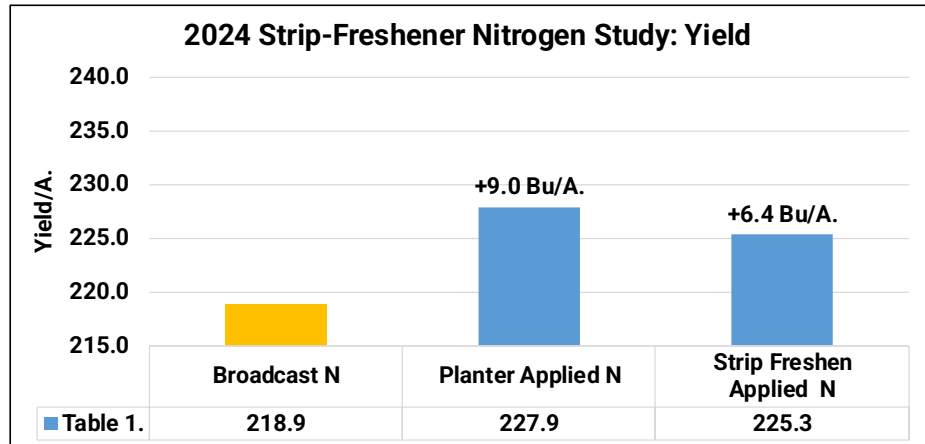
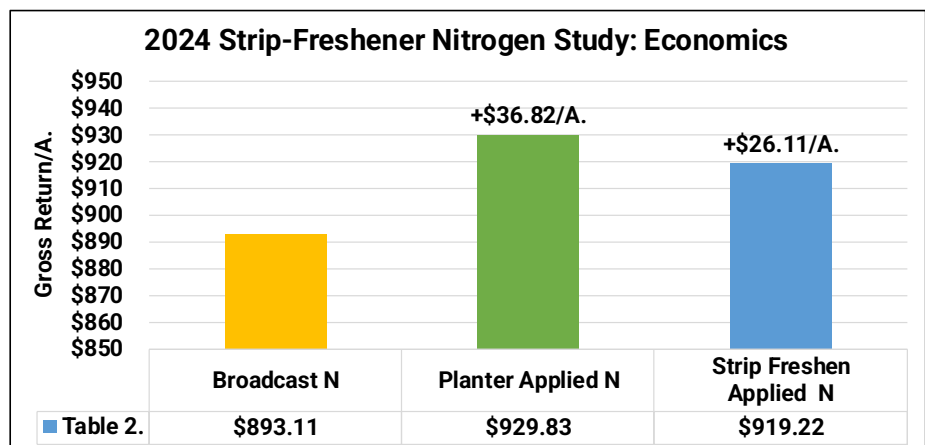

Table 2. illustrates gross return on investment with gains of +\$36.82/A. for planter applied N and +\$26.11 for strip freshener applied N, leaving a +\$10.71/A. advantage for the planter system.



A grower would need to evaluate total cost of each system to

determine net return on investment. However, we know strip freshening would occur an annual basis of at least **-\$10/A.** for the additional physical trip across the field each year. If freshening strip-till strips in the spring would typically bring yield increase, then this management practice could be very feasible.

We also know that planter applied N would have the initial cost of the Conceal® system on the planter itself, however with a gross return of +\$36.82/A., a 16 row planter equipped with a dual-band system would potentially break-even after near 650 acres. In many cases, this could be a one year break-even purchase, with potential very little to no cost after.

Planting Date: May 14<sup>th</sup>    Hybrid: Becks 6041Q™    Population: 34K    Row Width: 30"    Rotation: CAB    Corn Price: \$4.08    Custom Freshen Cost: \$10/A

Conceal® Dual Band System: \$1500/row

Planter Size: 16 Rows

Broadcast N: Weed-N-Feed 32%UAN Pre-Plant.

## Soybean Table of Contents:

### **Soybean Planting Principles:**

Planting Date	179
Multi-Year Early Plant Date	180
Soybean Early Plant Maturity	181
Starter Fertilizer Response by Date	182-183
SmartDepth® Planting Depth	184-186
Reveal® Residue Management	187-189
CleanSweep® Residue Management	190-191
Downforce Management	192-194
Keeton® Seed Firmer	195
Multi Genetic Planting	196-197
Singulation	198
SeedRight Bundle Drop Singulation	199
High Speed	200
Tillage/Closing Wheels	201-202
REVLIN® HOPPER THROTTLE™	203
Ridomil Gold® Granular Fungicide	204
HyperSound Technology Seed Treatment	205
Cover Crop Study	206-208
Summers® Rolling	254
Chopping Corn Head	270
Row Width and Seeding Rate	255-256

### **Soybean Dry Fertilizer Studies:**

Broadcast vs Banding	209
Broadcast vs Banding Rate Efficiency	210-212
Mosaic® Sulfur/Boron	213-214
Liquid vs Dry Fall Strip Till	215-217
Calcium Products SO4®	218

### **Soybean FurrowJet® Programs:**

Aqua Yield® NanoCS™	247-248
FurrowJet® Side-Wall	252

### **Soybean Foliar Programs:**

Revytek™ Foliar Fungicide	257
Fungicide/Insecticide	258-259
Miravis® Neo™ Foliar Fungicide	260-261
Aqua Yield® NanoPro®	262

### **Soybean Conceal® Programs:**

Marco Fertilizer Conceal® 14-12-4-6S	245
14-12-4-6S + NanoN+®	246
Phyco Terra®	250 - 251

### **Soybean Tillage Studies:**

Soybean Tillage	265-267
Pre-Strip Vertical Tillage	268
Spring Strip Till	269

### **Soybean Intensive Mgt. Studies:**

NETAFIM™ Irrigation Study	219
Soybean Seed Size	220
High Management Nachurs®	221-224
High Management AgroLiquid®	225-228
High Management Marco	229-232
High Management QLF®	233-236
High Management Corteva™	237-240
New Fields Ag™/NMS High Mgt	241-244
Dryland vs Irrigated ROI	249
Green Lightning PAW	263-264

## Soybean Planting Date Study

**Objective:** To evaluate various soybean planting dates throughout the spring to determine optimum planting date. Once optimum yield is discovered, data can then be analyzed to determine the deviation of yield at both early and late planting dates compared to traditional norms. With the recent trend of earlier soybean planting dates achieving higher yields, it is our intention to plant as early as possible in this study and plant every week throughout the spring planting season when fit.

**Results:** Table 1. illustrates the results of six planting dates over March 13<sup>th</sup>, April 16<sup>th</sup>, May 11<sup>th</sup>, May 22<sup>nd</sup>, June 3<sup>rd</sup> and June 12<sup>th</sup>. Optimum planting date occurred on May 11<sup>th</sup>, receiving the highest yield of 76.1 Bu/A.

Early March 13<sup>th</sup> plantings were unsuccessful, as yield fell **-20.1 Bu/A.**, mainly due to drought conditions in July and August. These yield losses equated to revenue of losses of **-\$230.35/A.**

April 16<sup>th</sup> planting dates realized yield losses of **-5.7 Bu/A.**, with economic losses of **-\$65.32/A.** After May 11<sup>th</sup>, the yield fell **-1.9 Bu/A.** with losses of **-\$21.77/A.**, June 3<sup>rd</sup> at **-2.5 Bu/A.** and **-\$28.65/A.**, June 12<sup>th</sup> at **-8.0 Bu/A.** with losses of **-\$91.68/A.**

Early planted soybeans have generally resulted in some of the highest soybean yields at the PTI Farm. However, lack of late season rainfall simply hurt early soybean dates before May 11<sup>th</sup>. These early plantings resulted in severe drought during critical reproductive periods in July and August.

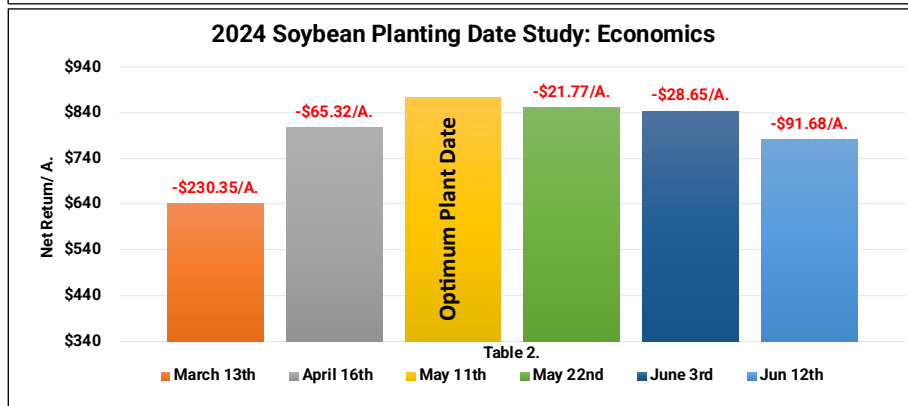
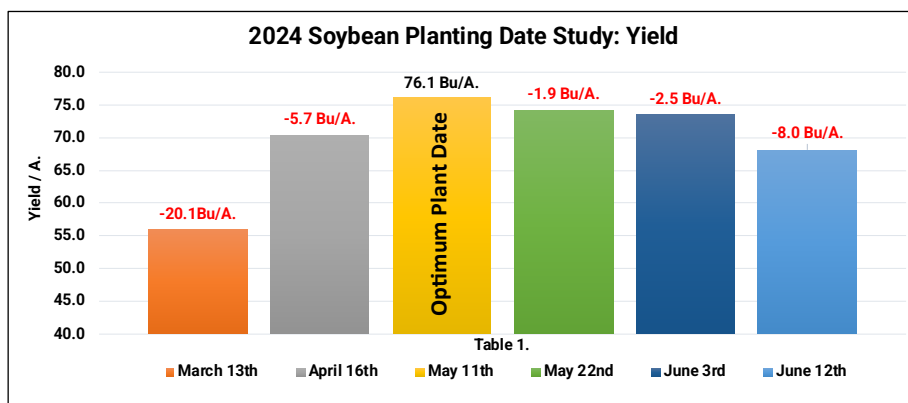

Planting Date: Varied    Variety: Golden Harvest 3994E3    Population: 120K    Row Width: 30"    Rotation: BAC    SB Price: \$11.46

## Multi-Year Early Plant Date Soybean Study:

**Objective:** To evaluate the yield and economics of early planted soybeans compared to traditional later soybean plant dates. Pushing planting dates earlier; extends the growing season, leading to earlier flowering dates, and overall higher yield potential.

**Results:** The table below illustrates multi-year early planted soybean data from the PTI Farm. Traditionally, planting dates during the first week of May is very common for soybeans. However, multi-year data from 2018-2024 has proven earlier planting can result in significant yield increases.



Ultra-early planting dates in March have accomplished +9.0 Bu/A. yield gains compared to that of traditional planting dates in the first week of May. As planting dates were made in either the first half or second half of April, yield gains of +8.4 Bu/A. to +11.8 Bu/A. were observed, giving an additional \$135.70/A.

In general, PTI data suggests that if a grower is capable of moving planting dates earlier, increased yield is obtainable if managed correctly. Simply moving planting date earlier to the last half of April has increased soybean yield by +17.8%, compared to first half May plantings.

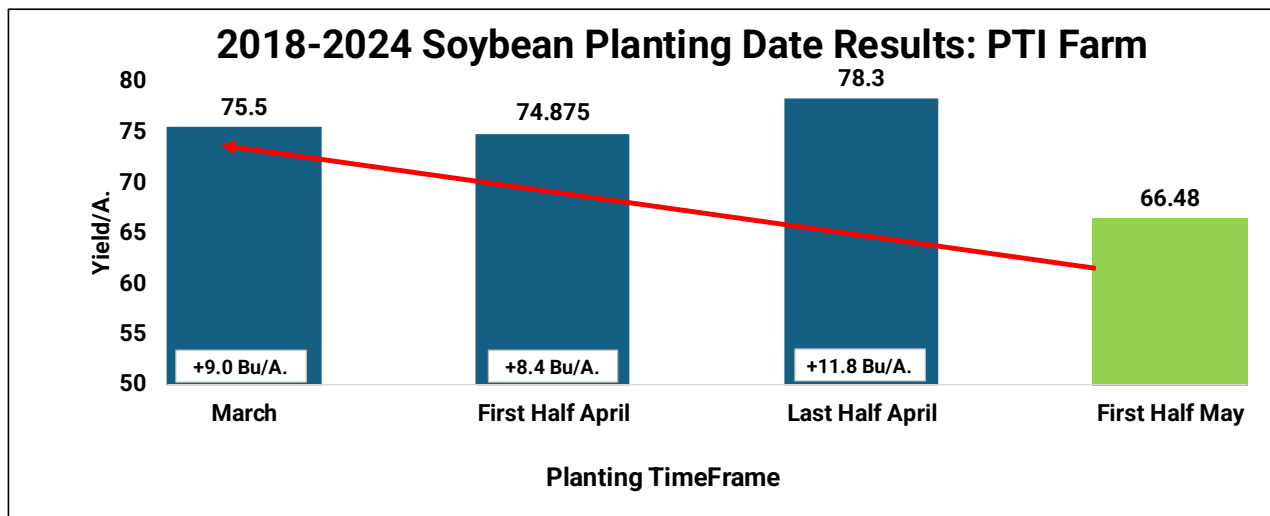

## Soybean Early Plant Maturity Study

**Objective:** With the recent trend of earlier soybean planting dates achieving higher yields, it poses the question “If I plant soybeans early, should I plant an earlier or later maturing soybean?” This study evaluates the difference in yield from a group 3.0 and 3.9 maturity soybean planted on March 13<sup>th</sup>, April 16<sup>th</sup>, and May 11<sup>th</sup>.

**Results:** Table 1. illustrates the later 3.9 maturity soybean outperformed the early 3.0 by +6.4 by to +8.0 Bu/A. in the three early planting dates.

Currently, 2022-2024 multi-year data has proven +4.5 Bu/A. average yield advantages over the earlier soybean maturity in early planting situations.

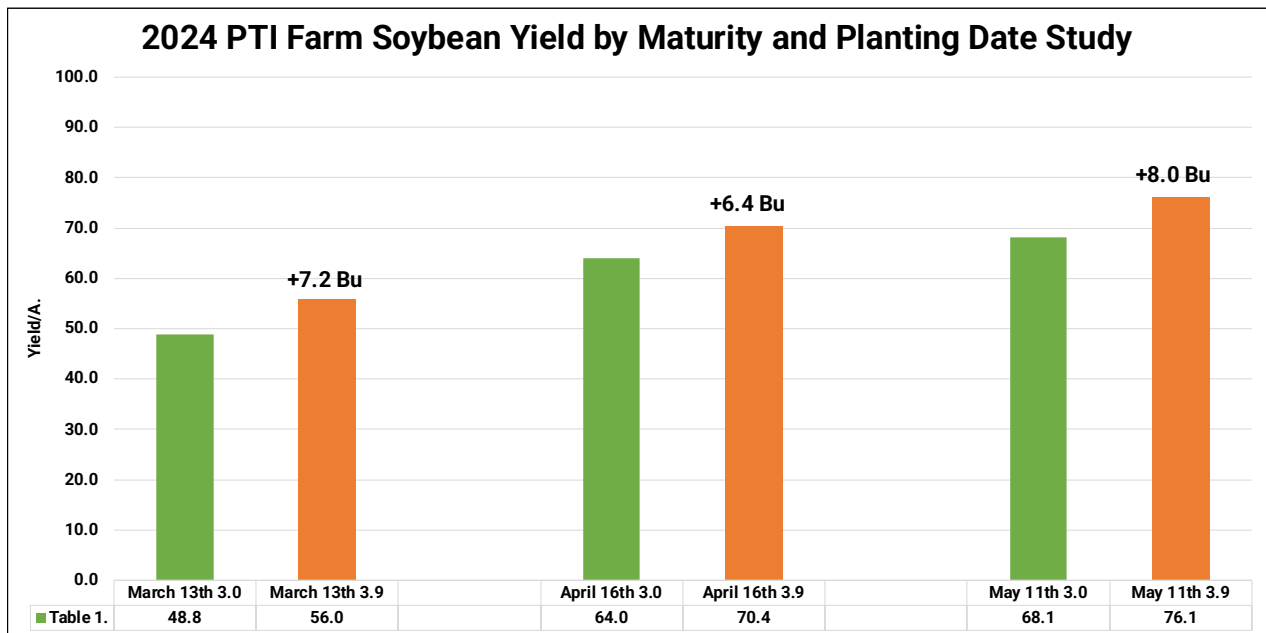

Planting Date: Varied Variety: Golden Harvest® 3035E3,3994E3 Population: 120K Row Width: 30" Rotation: BAC SB Price: \$11.46

## Soybean Starter Fertilizer Response by Planting Date Study

**Objective:** To monitor the performance of starter fertilizer at various planting dates. When does starter fertilizer give the highest returns? Does starter fertilizer respond differently at earlier planted dates versus later? In this study we evaluate five planting dates consisting of March 13<sup>th</sup>, April 16<sup>th</sup>, May 11<sup>th</sup>, May 22<sup>nd</sup>, and June 3<sup>rd</sup> with and without a starter fertilizer, monitoring its performance throughout the planting season.

The starter fertilizer program used for this study consists of the following:

<u>Product</u>	<u>Fertilizer Analysis</u>	<u>Placement of Fertilizer</u>
1 Qt/A. FaceOff®	1-0-1-.3Cu-.6Mn-.005Mo-3.0Zn	FurrowJet® Center
2 Qt/A. KFuel®	0-0-24	FurrowJet® Center
3 Gal/A. Triple Option®	4-13-17-1S	FurrowJet® Wings
2 Gal/A. K-Fuse®	6-0-12-12	Conceal®
2 Gal/A. Nachurs Throwback®	8-27-4-2S	Conceal®

All starter fertilizer treatments were implemented as a re-allocation program where \$30/A. was removed from the fall dry program to prevent over-application and overspending of nutrients.

Figure 1. FurrowJet® Placement

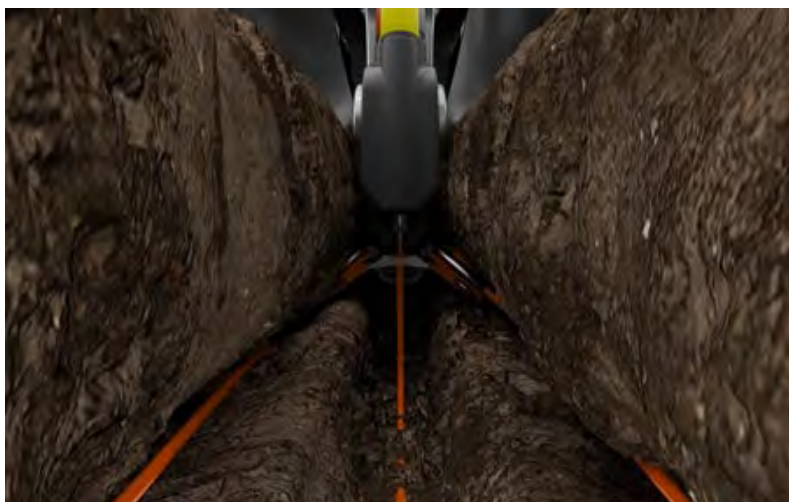

Figure 2. Conceal® Placement



## Soybean Starter Fertilizer Response by Planting Date Study Continued

**Results:** Table 1. illustrates all starter fertilizer treatments offered positive yield and economic returns at each of the five planting dates. 2024 starter fertilizer treatments offered the highest yield gains of +6.4 Bu/A. at the April 16<sup>th</sup> planting date and resulted in highest economic gains of +\$56.18/A.

As planting dates shifted past May 11<sup>th</sup>, yield gains slipped to +3.8 Bu, however they still offered economic gains of +\$26.39/A. Planting dates progressing later into June, proved yield gains falling to +1.6 Bu/A., but with positive net return of +\$1.17/A.

Multi-year data over 2021 to 2024 has proven highest average net return at March and April soybean plantings with net returns of +\$26 to near \$33/A., May plantings falling to +\$22/A., while June plantings failed to offer enough yield gain to offset the fertilizer cost with net losses of **-\$24.08/A.**

The flexibility of re-allocating and adjusting fall plow down to allow for a starter fertilizer on the planter creates a tool in the toolbox for growers to combat cool wet challenging spring weather.

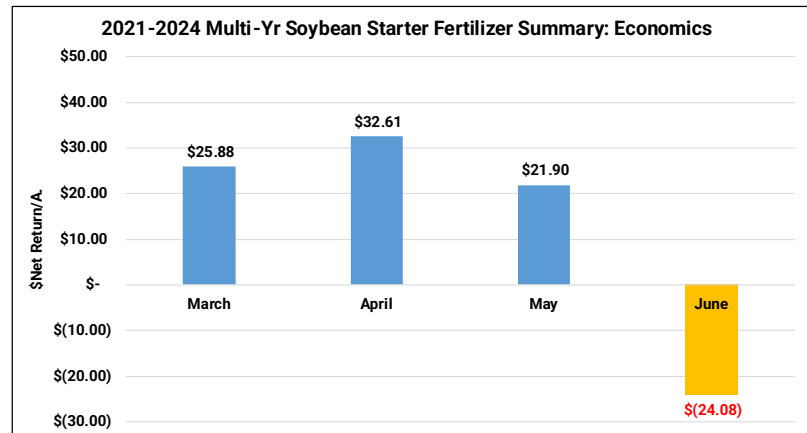
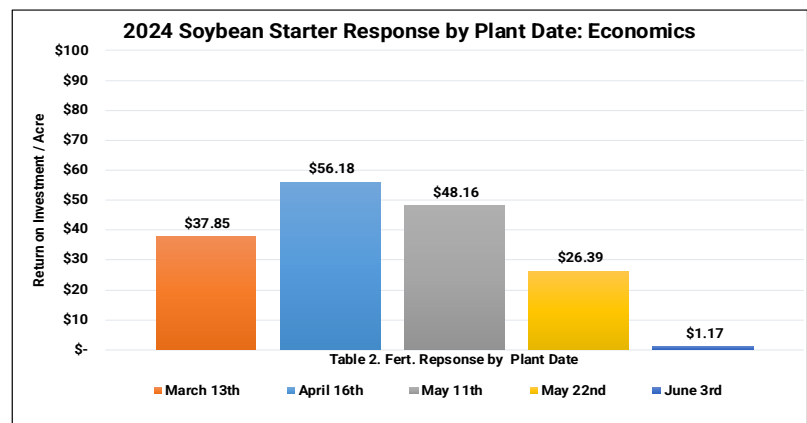
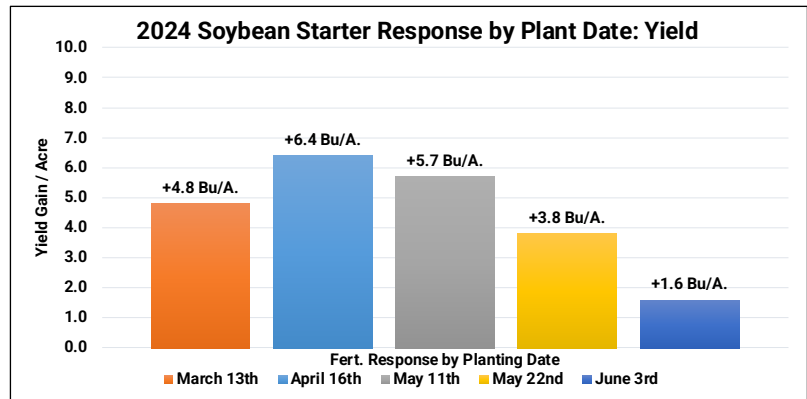

Planting Date: Varied    Variety: GH 3994E3    Population: 120K    Row Width: 30"    Rotation: BAC    SB Price: \$11.46

K-Fuel: \$5.70/Gal    FaceOff: \$16.85/Gal    K-fuse@: \$5.70/Gal    Nachurs Throwback: \$4.90/Gal    Triple Option: \$6.30/Gal    \$30 Fertilizer Reallocation

## SmartDepth® Soybean Planting Depth Study

**Objective:** To evaluate yield and economic performance of various manual soybean planting depths consisting of 1" to 3" in ¼" increments, compared to automated variable depth planting using SmartDepth® control.

Digging seeds is a time consuming yet important task at planting time (Figure 1). Getting your eyes on the furrow where the seeds are placed will allow you to understand if those seeds are in an environment to thrive. Is the seed being planted into adequate moisture? Until now, we didn't know this for every seed, and we were unfortunately simply guessing.

Figure 1. Seed Furrow



With a SmartFirmer® sensor (Figure 2.) you can now have virtual eyes in the furrow. Soil moisture is a critical component for seed germination, uniform plant emergence, and ultimately crop yield. SmartFirmer® sensors gives row-by-row visibility to soil moisture in the seed furrow, allowing farmers to choose the right planting depth as soil conditions change. Currently, the recommendation for ideal furrow moisture levels to achieve adequate soybean emergence, is near 32%. Using the 20|20® monitor (Figure 3.) in tandem with SmartFirmer® sensors, we now have the ability to evaluate furrow moisture in real-time. Based on this real-time information, growers can make decisions based on live sensing data.



Figure 3. 20|20® Monitor System



Figure 2. SmartFirmer® Sensor



## SmartDepth® Soybean Planting Depth Study

Figure 4. illustrates SmartDepth®, a unique product that takes the technology one additional step further, allowing planting depth to be changed on a planter, by section or individual row basis. This can be done manually from the tractor cab and 20|20® console, or automatically using furrow moisture values from SmartFirmer® sensors. Growers can customize their own settings to optimize both furrow moisture and planting depth values (Figure 5). This control allows growers to measure, react, and take control of planting depth to optimize emergence timing.

Figure 5. SmartDepth® Customization Screen



Figure 4. SmartDepth® Control System

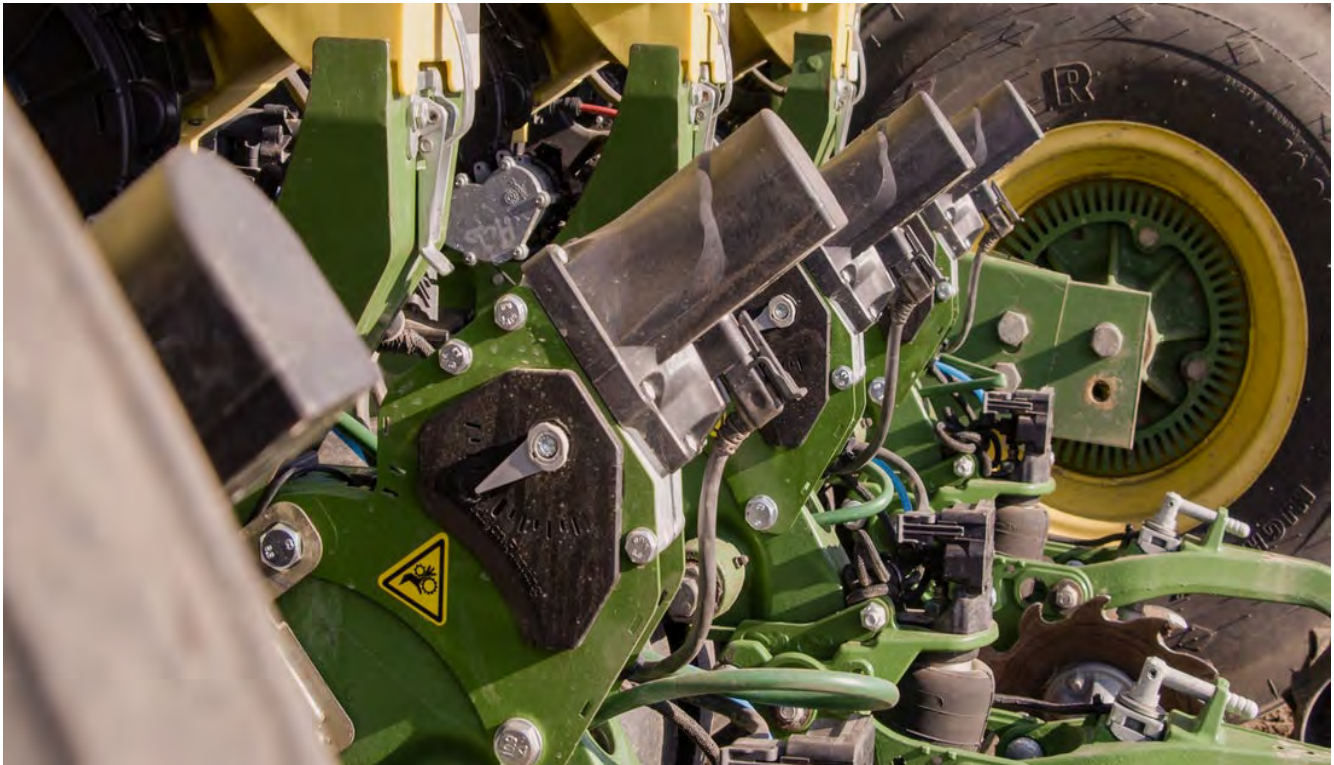

## SmartDepth® Soybean Planting Depth Study

**Results:** Tables 1-2. reveal that SmartDepth® did offer the highest yield in the study at 63.2 Bu/A. The 1.5" planting depth fell short of SmartDepth® by **-0.4 Bu/A.** In 2024, 2.75" was the lowest yielding depth at **-2.6 Bu/A.** off the pace.

Table 3. illustrates average furrow moisture of 39.9% across all planter rows when SmartDepth® was implemented to obtain ideal planting depth into moisture. Currently, the recommendation for ideal furrow moisture levels to achieve adequate soybean emergence is near 32%.

More work needs to be done to understand how to continually customize settings to achieve proper planting depth automatically. However, it does appear that by using SmartDepth®, SmartFirmer® and a 20|20® monitor system, growers can measure and chase the furrow moisture line and adjust planting depths as they deem appropriate.

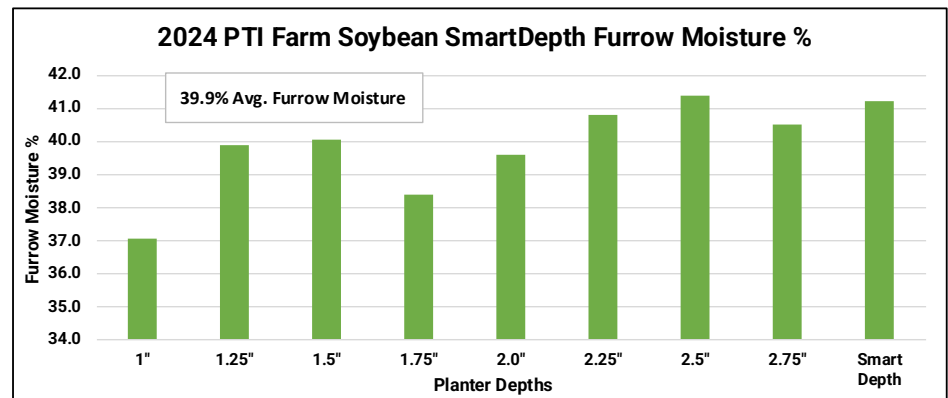
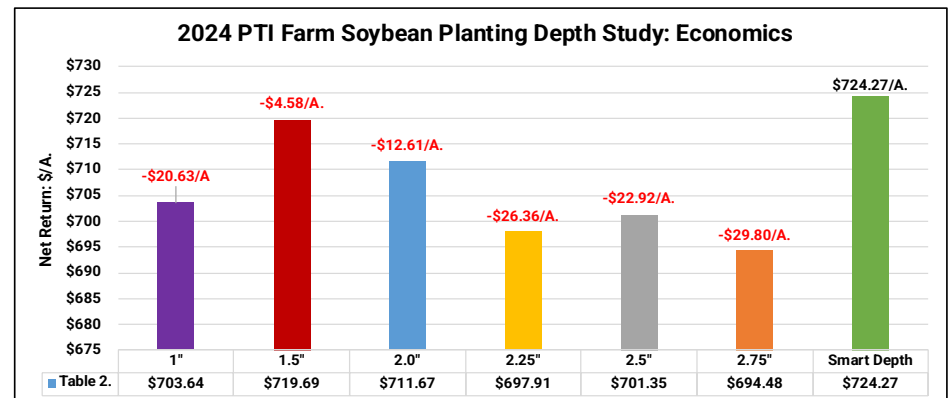
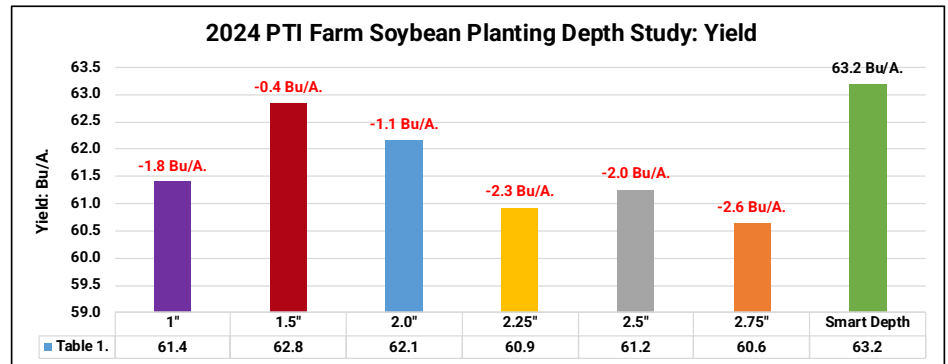

Planting Date: May 15<sup>th</sup> Variety: Golden Harvest 3533E3 Tillage: Strip-Till Population: 130K Row Width: 30" Rotation: BAC Soybean Price: \$11.46



## Reveal® Residue Management Study Continued

**Results:** Table 1. illustrates the Reveal® residue management system resulted in positive yield gains +4.0 to +5.1 Bu/A. compared to the absence of row cleaners. Floating row cleaners proved losses of **-4.0 Bu/A.** over a 20 PSI settings proving highest yield.

Residue management in the furrow is crucial for optimum yield and highest revenue potential. At \$11.46/Bu. soybeans, a yield gain of +5.1 Bu/A. when using the correct setting would result in increased farm revenue of \$58.45/A. and proves to be a core principle of planting that a grower should not overlook.

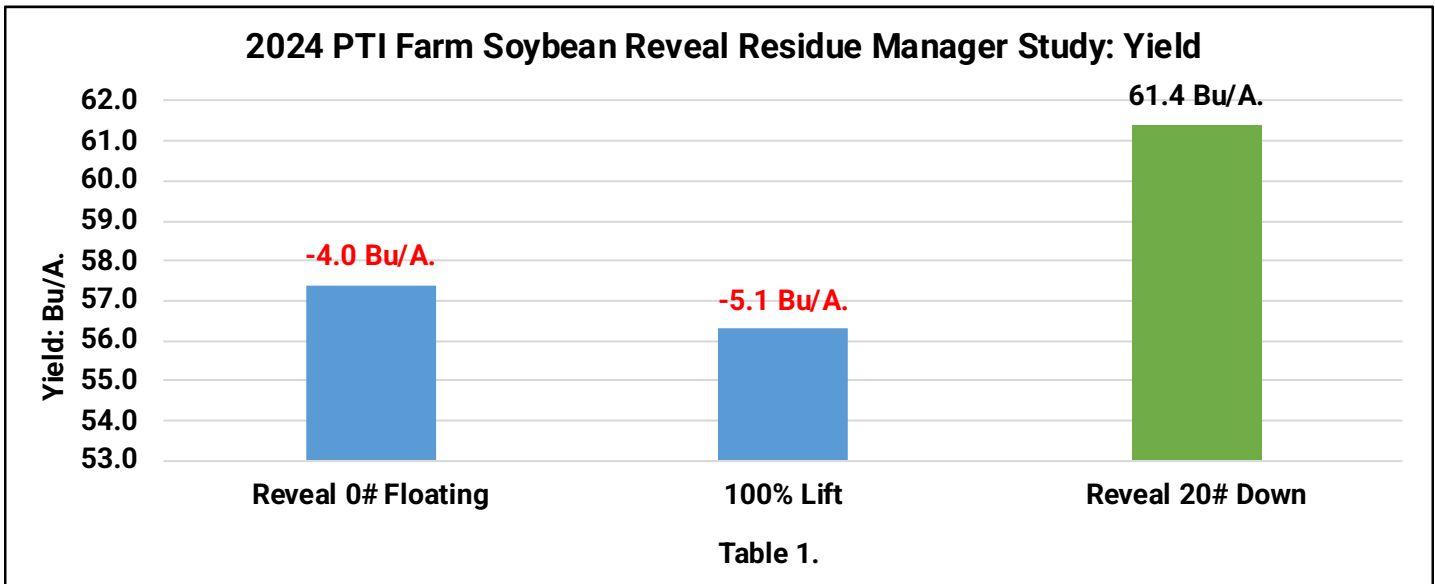

## Reveal® Residue Management Study Continued

**Results:** Table 2. illustrates the Reveal® residue management system set at 20 PSI resulted in positive yield gains, averaging +4.6 Bu/A. When running no residue management system there was a loss of **-5.1 Bu/A.** resulting in an economic loss of **-\$58.45/A.** Running a residue management system in the floating position resulted in an economic loss of **-\$45.84/A.**



Table 3. Illustrates multi-year data comparing no residue managers and floating residue managers to Reveal set at 20 PSI down. Over the past five years 20 PSI had an economic advantage of +\$38.00/A. over no residue management system and +\$19.97/A. over a floating residue management system.

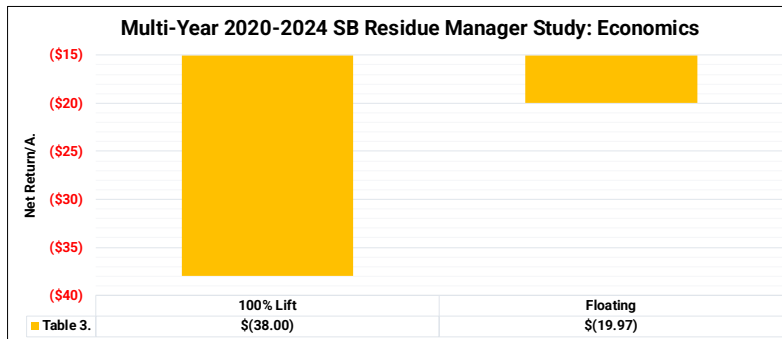
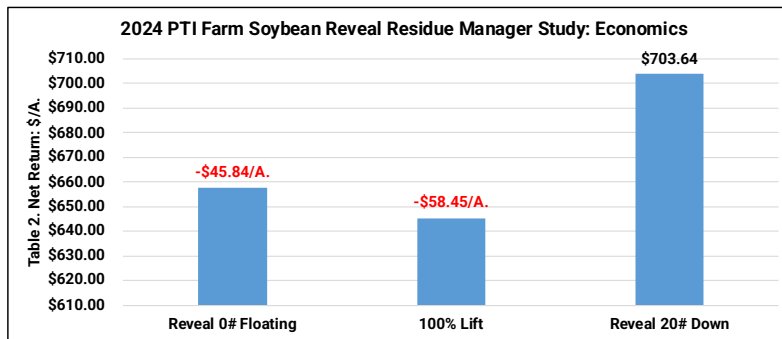

Planting Date: May 24<sup>th</sup>    Variety: Golden Harvest 3035E3    Tillage: Strip-Till    Population: 130K    Row Width: 30    Rotation: BAC    SB Price: \$11.46

## CleanSweep® Residue Management Study

**Objective:** This study evaluates the benefits of planter row cleaners equipped with CleanSweep® cylinders. Residue management has become a necessary part of today's operation to maximize profitability. Tougher stalks and more corn-on-corn acres mean a heavier load of residue that needs to be controlled. Residue in the seed trench competes with seedlings for moisture and harbors disease. CleanSweep® cylinders put row cleaners right where they need to be, moving residue but not the soil. Continuous adjustments can be made as field conditions change with the cab-mounted controller to easily lift or make more aggressive adjustments.

In this study, we use air pressure to adjust CleanSweep® cylinder settings on Yetter 2967 spike row cleaners to allow the ability to change and evaluate the aggressiveness of row cleaners. These settings were then evaluated to study yield and economic advantages.

These agronomic settings consisted of:

- Lifting the row cleaners 100% to simulate the lack of row cleaners.
- A "floating" (0# psi) position that allows the row cleaner to ride along top of the soil surface with no air control, lift, or down-pressure.
- 20# of air down-pressure, just aggressive enough to wipe crop residue and clods out of the way to lead a clean path ahead of the planter gauge wheels and seed disc openers.

Figure 1. CleanSweep®



## CleanSweep® Residue Management Study Continued

**Results:** Table 1. illustrates CleanSweep® cylinder multi-year yield results from the PTI Farm. Over 4 years of data, no row cleaners provided an average yield loss of **-1.75 Bu/A.**, compared to the 20PSI down grower setting. Floating row cleaners proved average gains of +0.22 Bu/A. compared to the more aggressive grower setting of 20#psi down.

Tables 2. Summarizes average economic gains from CleanSweep® cylinders during the 20, 21, 22, 24 growing seasons. During this time-period, row cleaners equipped with CleanSweep® cylinders at 20#psi down realized a +1.75 Bu/A. yield gain compared to using no row cleaners. These gains resulted in gross revenue increases of +\$19.60/A.

This same 20#psi down setting also had decreased yields over the 0# float position by **-0.22 Bu/A.** and consequently decreased revenue by **-\$3.01/A.**

Figure 2. Yetter Row Cleaners with CleanSweep®

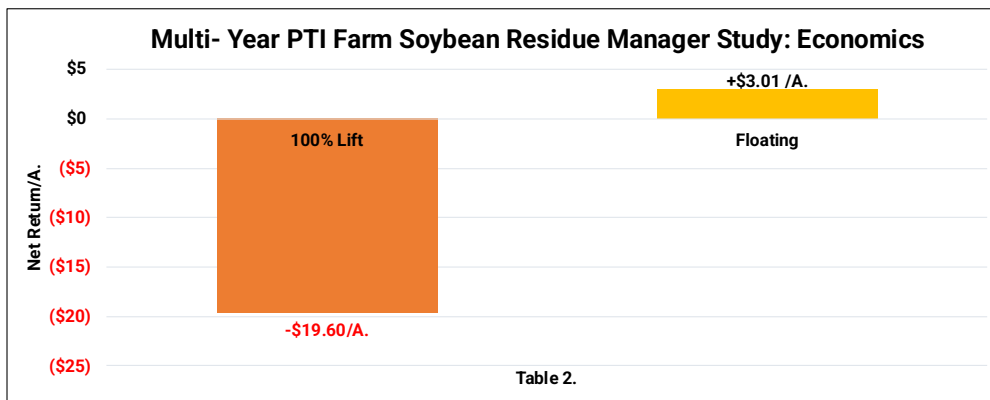
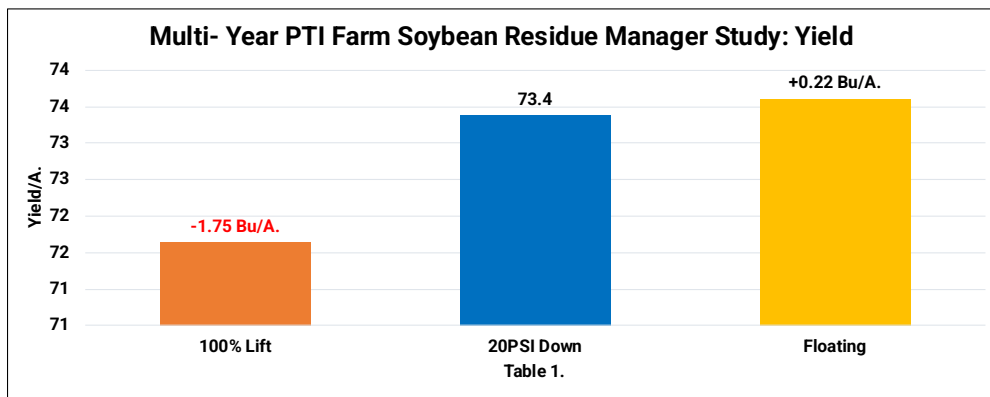

Planting Date: May 24<sup>th</sup> Variety: GH 3035E3 Population:130K Row Width: 30" Rotation: BAC Soybean Price: \$11.46

## DownForce Management Study

**Objective:** This soybean study evaluates yield impact of implementing proper downforce compared to too light or too heavy row unit settings. Planter row unit downforce is a common agronomic issue that often goes unaddressed. When downforce matches field conditions, the depth of planting is consistent and correct. Too light of row unit downforce causes planting depth to shallow up, potentially placing seed in dry soil, creating poorly rooted plants that struggle for water and nutrients. Conversely, too much downforce can lead to furrow side-wall compaction, also creating an environment that can cause limited plant access to water and nutrients.

DeltaForce® system replaces the springs or air bags on your planter with hydraulic cylinders (Figure 1). It automatically increases or decreases weight with military precision, on each row individually. When one row encounters conditions different than another (wheel tracks, old roadbeds, clay knobs, headlands, etc.), each will adjust independently (Figure 2). Row by row, foot by foot, even seed by seed an environment that fosters uniform germination, optimum growth and maximum yield can be produced.

Figure 1. DeltaForce® Cylinder



Figure 2.

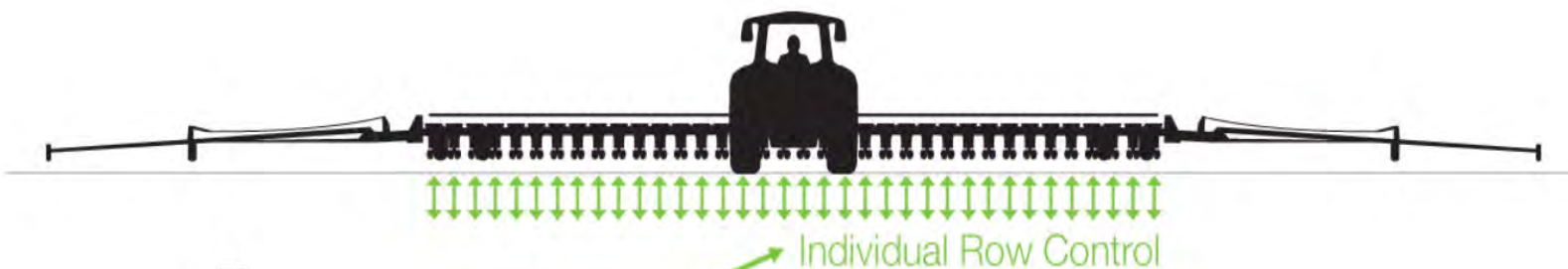



## DownForce Management Study Continued

**Results:** Tables 1-2. illustrates the yield and economic response of DeltaForce® automated control compared to excessive and light downforce settings. Settings for this study include.

- Too light of Downforce (175# lift, 100# down)
- Proper Downforce (Automated Custom 90#)
- Excess Downforce (550# down, 100# up)

2023 data resulted with light downforce realizing yield gains of +0.4 Bu/A., with corresponding net economic gains of +\$4.58/A. Heavy downforce caused yield gains of +0.3 Bu/A., with economic losses of +\$3.44/A.

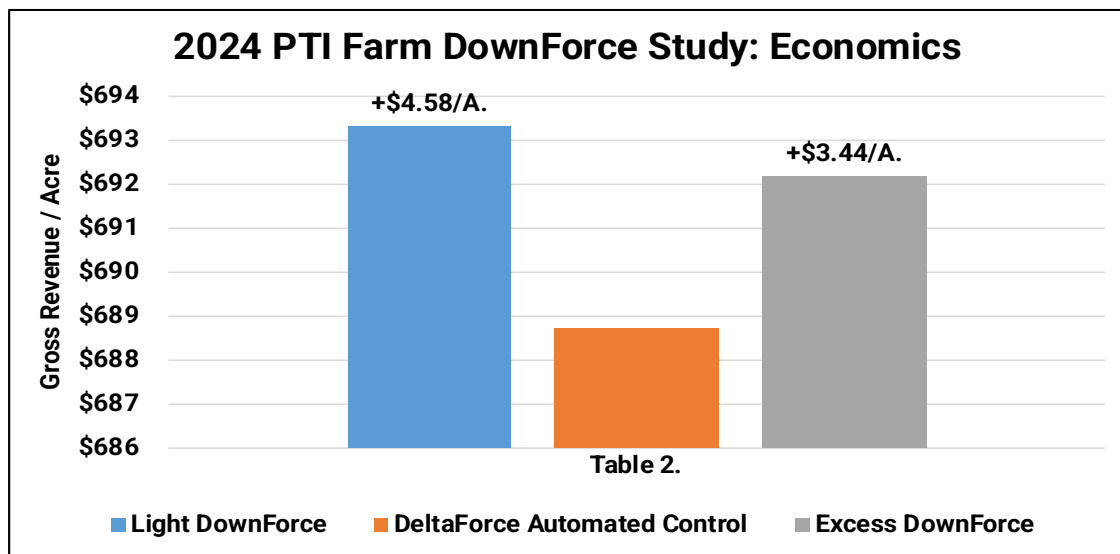
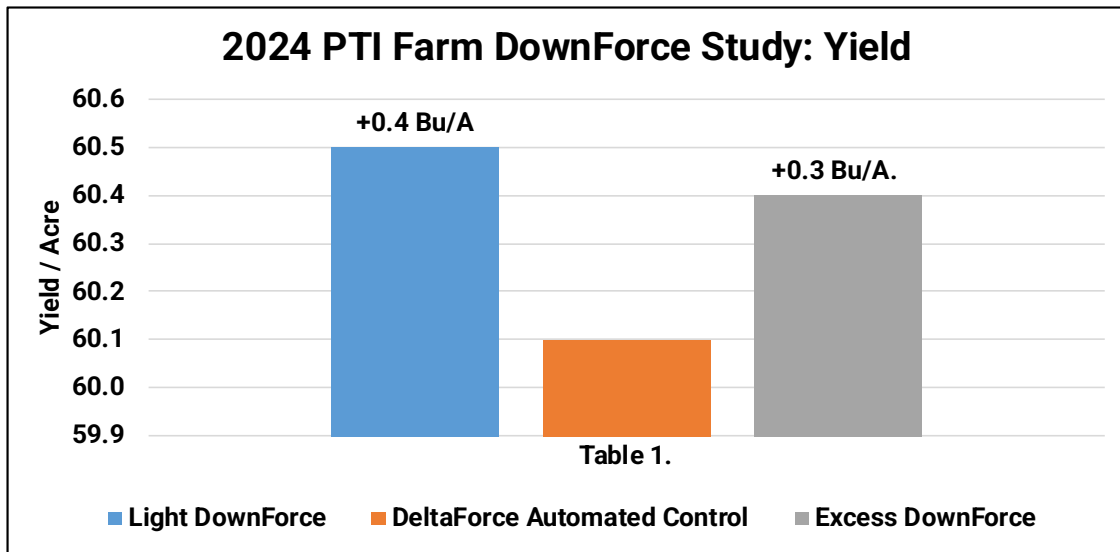

## DownForce Management Study Continued

Tables 3-4. illustrate multi-year data which resulted in light downforce having yield losses of **-1.8 Bu/A.**, with corresponding net economic losses of **-\$20.73/A.** Heavy downforce caused yield losses of **-0.9 Bu/A.**, with economic losses of **-\$10.78/A.**

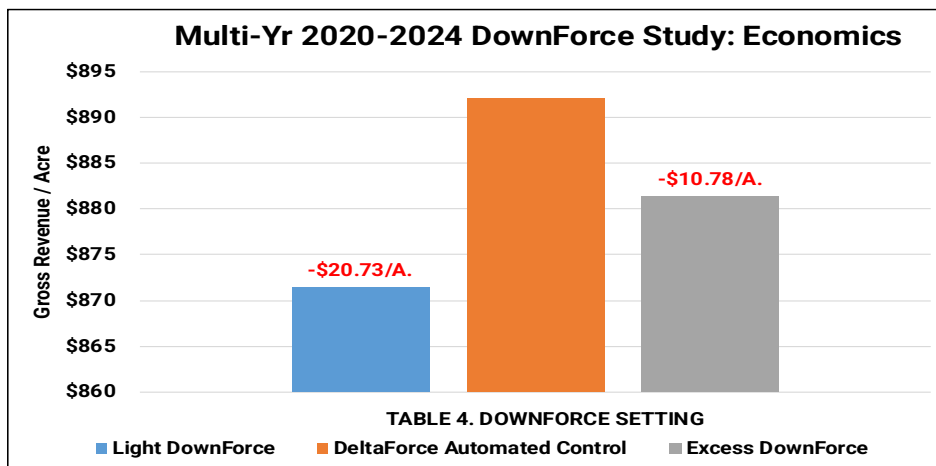
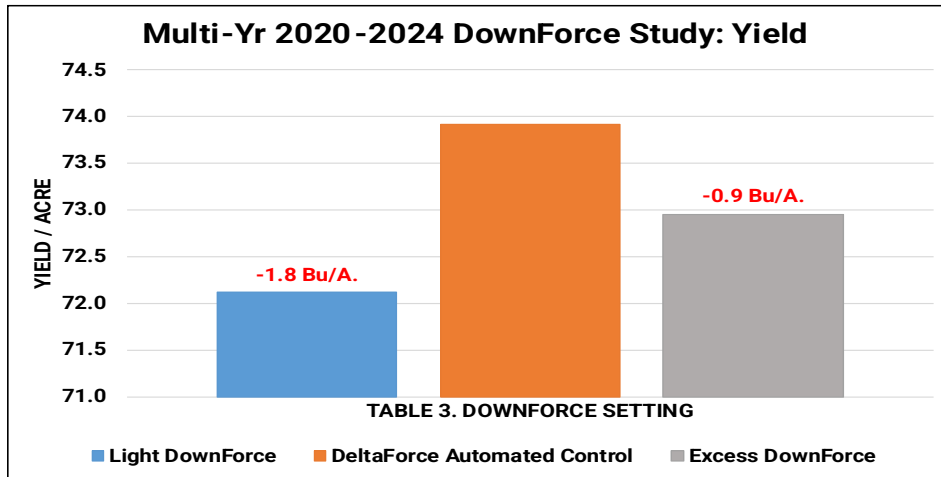

Planting Date: May 25<sup>th</sup>

Variety: GH 3533E3

Population: 130K

Row Width: 30"

Rotation: BAC

Soybean Price: \$11.46

## Keeton® Seed Firmer Study

**Objective:** This study evaluates the benefits of Keeton® Seed Firmers (Figure 1). Seeds don't always land right at the bottom of the trench where they belong. With its unique, in-the-trench design, the Keeton® Seed Firmer gently firms those seeds to the bottom of the V-trench (Figure 1). The end result is even depth, correct seed-to-soil contact, and most importantly uniform germination.

**Results:** Keeton seed firmers resulted in yield gains of +3.6 Bu/A. with a return on investment of +\$41.26/A. The table below illustrates multi-year data over the time period of 2020-2024 where Keeton® Seed Firmers have resulted in an average yield gain of +1.41 Bu/A, with a net return of +\$17.62/A. 2024 yield gains were significantly higher than previous years due to shallow planting. Keeton's ability to improve seed to soil contact helped offset the shallow planting.

At a cost of \$40/row for Keeton® Seed Firmers and quick attach brackets for a 16-row planter, using the +\$17.62/A. increase in revenue, break-even occurs at only 37 acres.

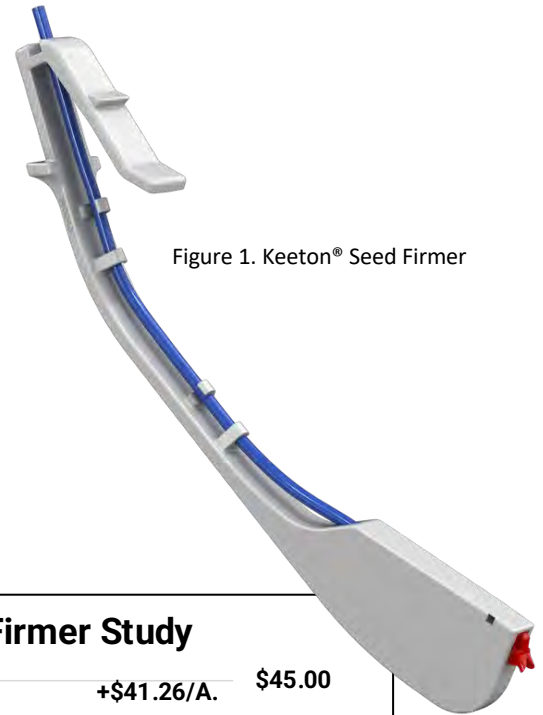
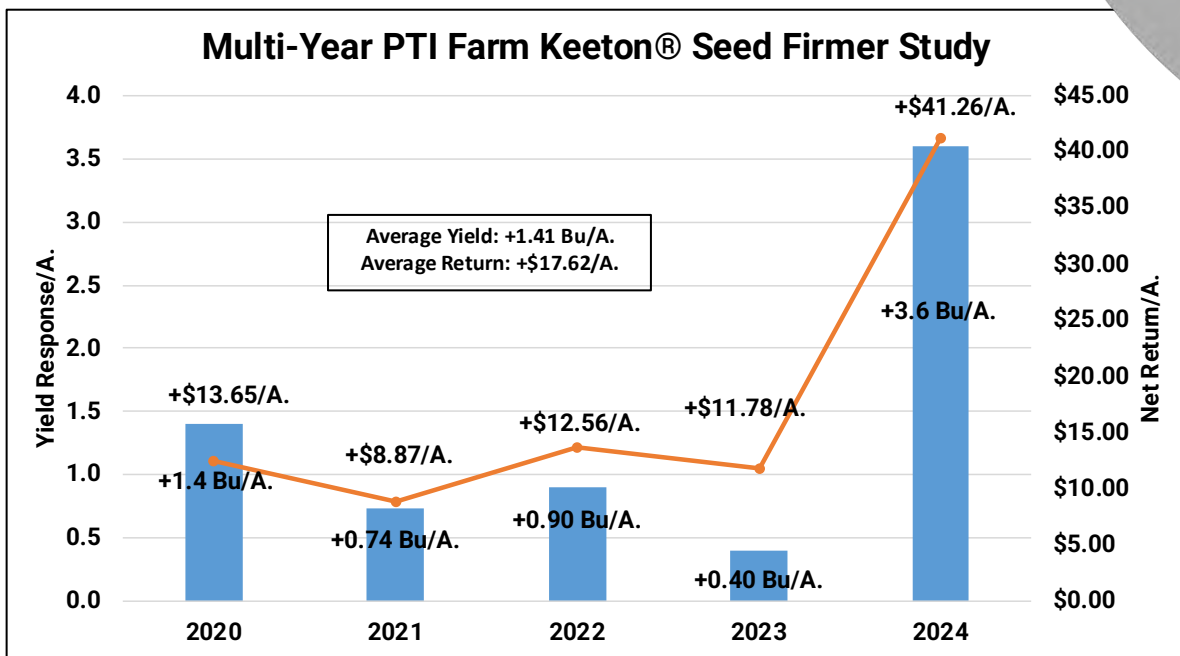

Figure 1. Keeton® Seed Firmer



Planting Date: May 25<sup>th</sup>

Variety: GH 3035E3

Population: 130K

Row Width: 30"

Rotation: BAC

Soybean Price: \$11.46

## mSet® Multi-Variety Soybean Planting

**Objective:** To analyze the yield and economic benefit of implementing mSet® single meter multi-genetic technology to place specific soybean varieties for individual spatial management zones.

mSet® is an upgradeable product to vSet® meters and vDrive® controller, which couples a seed selector added to the hopper to switch hybrids, and a seed pool level sensor in the meter (Figure 1.) The level sensor tells the seed selector when the meter needs more seed, and it drops a dose of seed into the meter. This continually happens until it is time to switch hybrids. At hybrid change, the level sensor will let the seed pool run low, then call for a dose of the other hybrid to enter the meter just in time for the change, leading to a short transition between varieties. The seed pool is controlled by the mSet® selector (Figure 2.), providing the correct hybrid in the meter, and allowing the vSet® meter to accurately singulate those seeds. The ultimate result is the hybrid you select, planted in the area of the field you select, planted with highest accuracy of singulation. Additionally, for those who want to both plant fast, and place varieties by spatial zone variability, SpeedTube® system can be used in tandem with multi-genetic technology (Figure 3).

Figure 1. mSet® Box

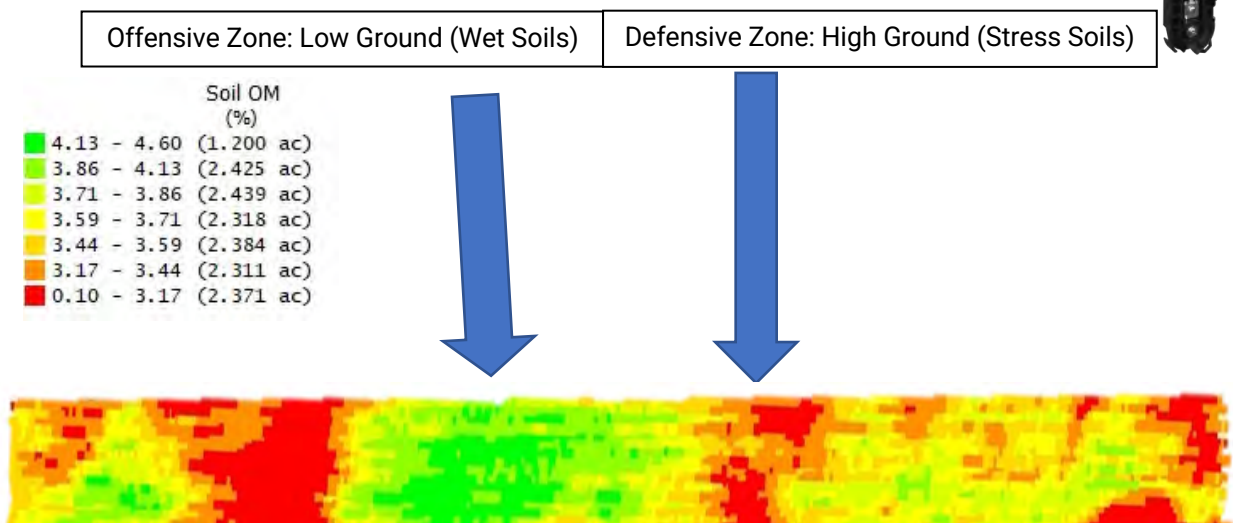

Figure 3. Speedtube®



Figure 2. mSet®

Figure 4. Offensive and Defensive Spatial Zones



## Multi-Variety Soybean Planting Study Continued

**Results:** For this spatial study, Golden Harvest 3774E3 was used as our offensive soybean variety in the lower elevation, higher OM, but potentially saturated soils. Conversely, Golden Harvest 3994E3 was used as the defensive variety planted into the higher ground, lower OM, and potentially droughty soils. Each genetic package was placed into the appropriate matching spatial management zone (Figure 4.) to evaluate the yield performance when varieties were placed correctly, as well as incorrectly.

Figure 5. illustrates the results of multi-variety soybean planting in 2024. Spatial variety placement in the defensive zones resulted in yield losses of **-2.2 Bu/A.** and corresponded to an economic loss of **-\$25.21/A.** Alternatively, spatial placement in the offensive zones resulted in yield gains of **+3.9 Bu/A.** with increased revenue of **+\$44.69/A.**

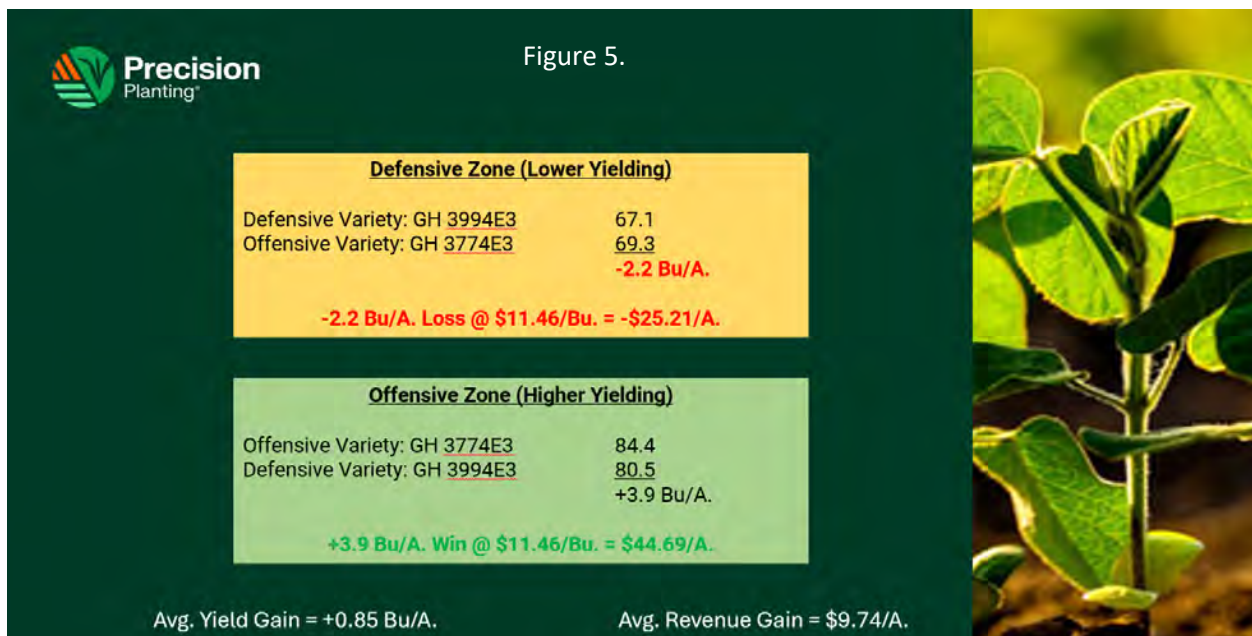

Based on this scenario, if a grower invested \$1000/row on a 16-row planter for multi-hybrid technology, these types of yield and economic gains would result in return on investment at 1642 acres. These yield results confirm that a multi-genetic system could offer yield advantages and potentially large economic gains if used properly. However, for this system to work growers and seedsmen need to work together to place the appropriate genetics on the correct acre and planted at suitable seeding rates. In 2024 the PTI Farm implemented the multi-variety program incorrectly by placing the wrong variety in the defensive zone. More work needs to be done to improve the win rate %, similar to research on multi-hybrid corn placement.

*Planting Date: May 23<sup>rd</sup>   Varieties: GH 3774E3, 3994E3   Population: 130K   Row Width: 30"   Rotation: BAC   Soybean Price: \$11.46*

## Soybean Singulation Study

**Objective:** To evaluate the agronomic and economic advantage of singulating soybeans. In this study we compare the use of an 80-hole vs 56-hole soybean crop kit (Figure 1). Typical spacing of soybean plants achieved with singulation is illustrated in Figure 2.

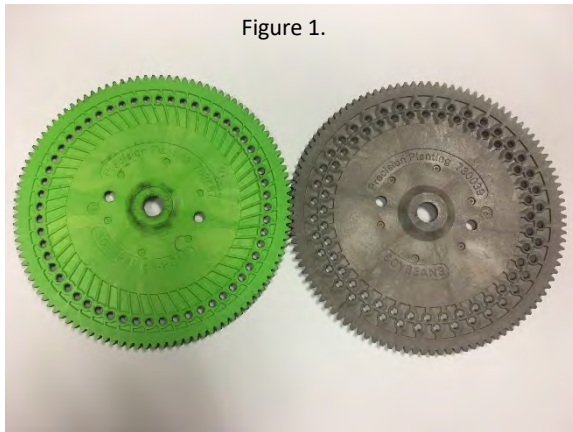

**Results:** The table below summarizes the yield increase of singulating soybeans with a 56 hole crop kit. 2019-2024 proved a +1.2 Bu/A. yield gain over this time period. Using these yield gains, along with the commodity price for each year, shows a +\$14.13/A. advantage over the gray 80 hole-disc.

The cost of upgrading to the 56-hole disc and new ejector wheel is \$58 a row assuming you already have a singulator. When using multi-year economic data, on a 16-row planter it would take a grower 66 acres to break-even on this low cost investment.

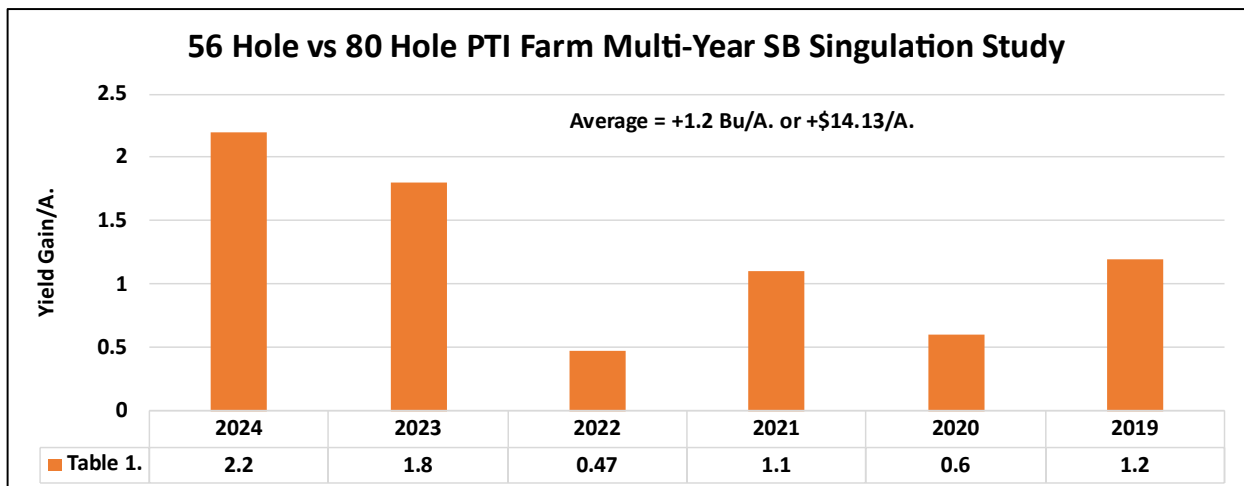

Planting Date: May 25<sup>th</sup>

Variety: GH 3035E3

Population: 125K

Row Width: 30"

Rotation: BAC

Soybean Price: \$11.46

## SeedRight BundleDrop Singulation Study

**Objective:** To evaluate the agronomic and economic advantage of planting soybeans into “bundles”. The SeedRight BundleDrop plate allows the ability to plant soybeans in bundles of four seeds. This “team” approach is designed to help improve emergence and overall plant stand by multiple soybean plants emerging at the same time in a concentrated area to fight through soil crusting.

**Results:** Table 1. illustrates a yield detriment of **-0.3 Bu/A.** for bundling seeds of four together with the SeedRight disc.

In our third year of testing BundleDrop, multi-year data proves **-1.7 Bu/A.** with corresponding economic losses of **-\$22.74/A.**



Figure 1. BundleDrop Plate

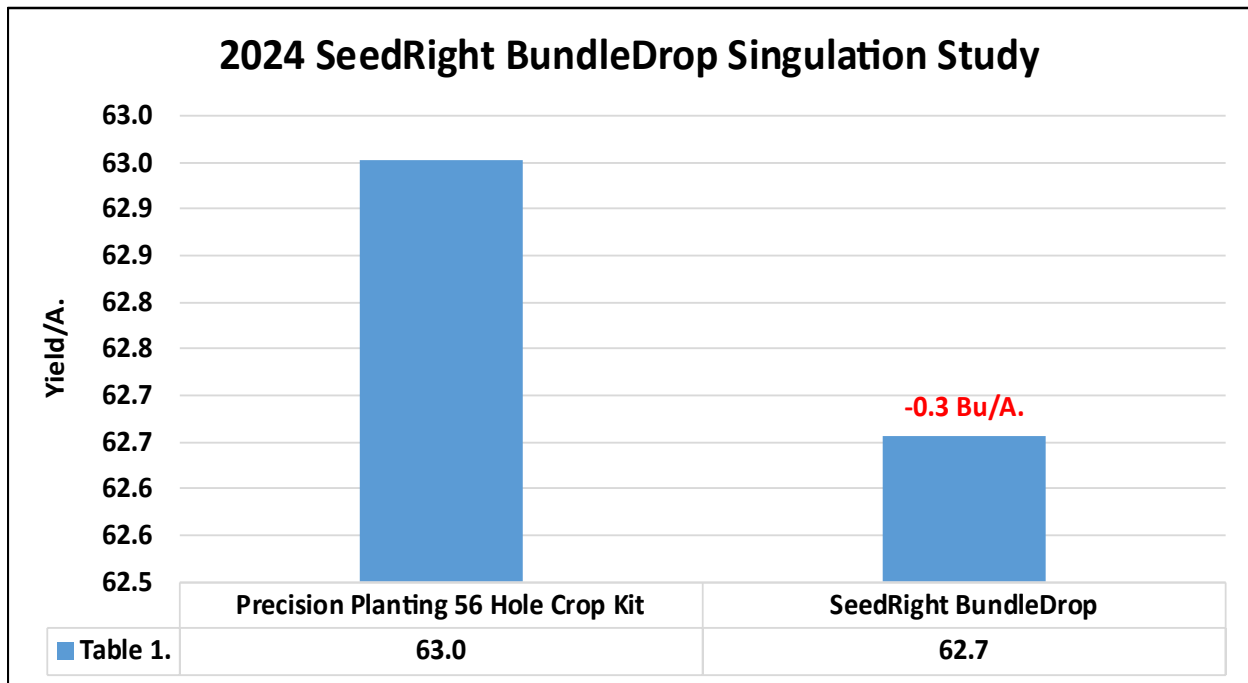

Planting Date: May 25<sup>th</sup>    Variety: GH 3533E3    Population: 130K    Row Width: 30"    Rotation: BAC    Soybean Price: \$11.46

## High Speed Soybean

**Objective:** To evaluate yield response of planting speeds 5 and 10 MPH with a SpeedTube® and regular seed tube system. SpeedTube® high-speed planting technology takes the place of conventional seed tubes and consists of a flighted belt. By transporting each seed to the furrow, there is no opportunity for seeds to ricochet into the trench. Even at twice normal planting speeds, seed arrives safely at the bottom of the trench, spaced evenly, every time.

**Results:** Using SpeedTube® technology, there was only a 1.4 Bu/A. range difference at planting speeds of 5MPH between the two systems. However, at 10MPH SpeedTube® proved additional yield gains of +2.3 Bu/A. compared to a normal SeedTube system.

This data would suggest that growers can plant at significantly higher speeds with SpeedTube® technology without sacrificing planter performance.

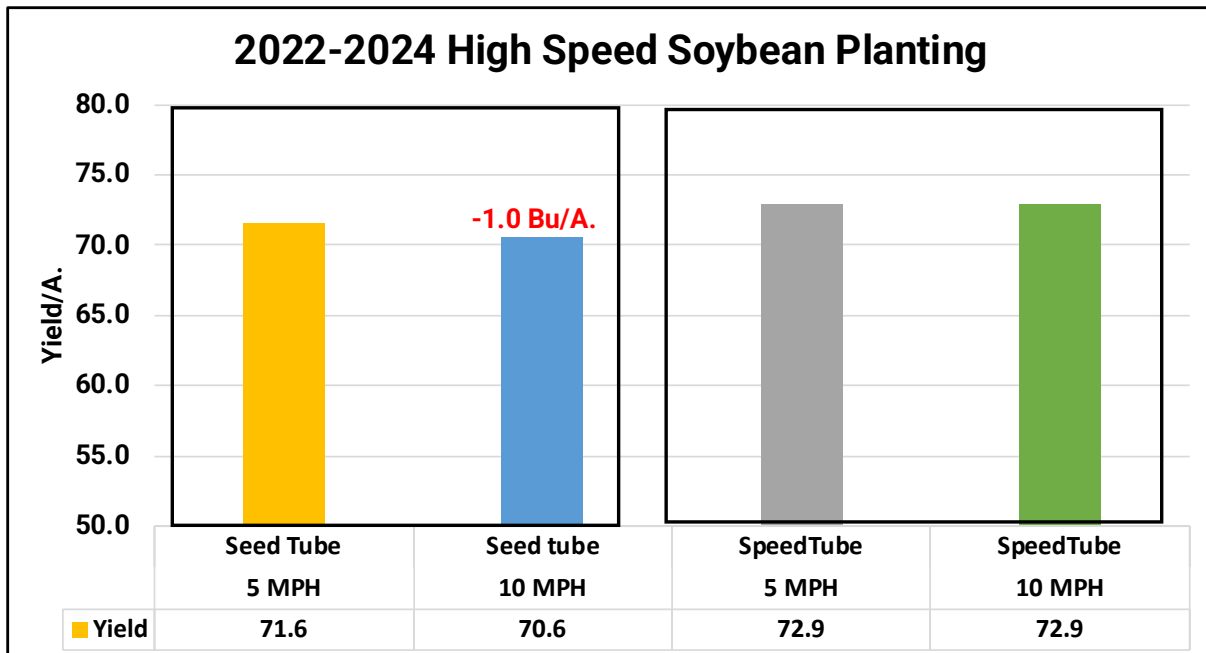

Planting Date: May 20<sup>th</sup> Variety: Pioneer37A18E Population: 130K Row Width: 30" Rotation: BAC Tillage: Strip-Till 56 Cell Crop Kit



## Soybean Closing Wheel Study

This closing wheel study evaluates yield and economics of six distinctly different types of closing wheel systems including the following:



### **FurrowForce® Closing and Automatic Control System:**

- Advantages:
- Lifts and fractures sidewall compaction/smear
  - 2nd stage stitching and removal of air pocket
  - Ability for automatic sensing/control of soil variability
- Disadvantages:
- Rocks can be problematic, increased cost



### **Non-Sensing Traditional Dual Rubber Closing System:**

- Advantages:
- Sealing or “Pinching” in dry conditions
- Disadvantages:
- Difficult to lift/fracture sidewalls, struggles to close furrow



### **Non-Sensing Dual Yetter Poly Twister® Closing System:**

- Advantages:
- Lifts and fractures sidewall compaction/smear
  - Center ring acts as depth maintainer
- Disadvantages:
- Lightweight wheels require increased tension



### **Non-Sensing Martin-Till® fCrusher Closing System:**

- Advantages:
- Tapered tooth design – Lightweight Cast
  - Allows firming and crumbling.
- Disadvantages:
- Single Stage, Potential to Overpack



### **Non-Sensing Dual Yetter Cast Twister® System:**

- Advantages:
- Ring-only option for easy installation
  - Allows firming and crumbling
- Disadvantages:
- Single Stage, Potential to Overpack

## Soybean Closing Wheel Study Continued

**Results:** Table 1. Illustrates FurrowForce® Auto Standard proved positive yield gains over all other closing systems. Dual Yetter Cast Twister® was **-0.6 Bu/A.** off Auto Standard. Martin Furrow Crusher came in next, within **-0.8 Bu/A.** of FurrowForce®. The other 2 single stage system had the most agronomic loss of **-2.4 Bu/A** to **-3.3 Bu/A.** respectively.

Table 2. Illustrates economics for each of these individual closing systems compared to FurrowForce® Auto Standard. Dual Rubber realized economic losses of **-\$37.82/A.** compared to Auto Standard FurrowForce®. Dual Yetter Cast Twister® closing system was **-\$7.45/A.** off the pace. All other single stage manual closing systems incurred net losses of **-\$9.45/A.** to **-\$27.50/A.** respectively.

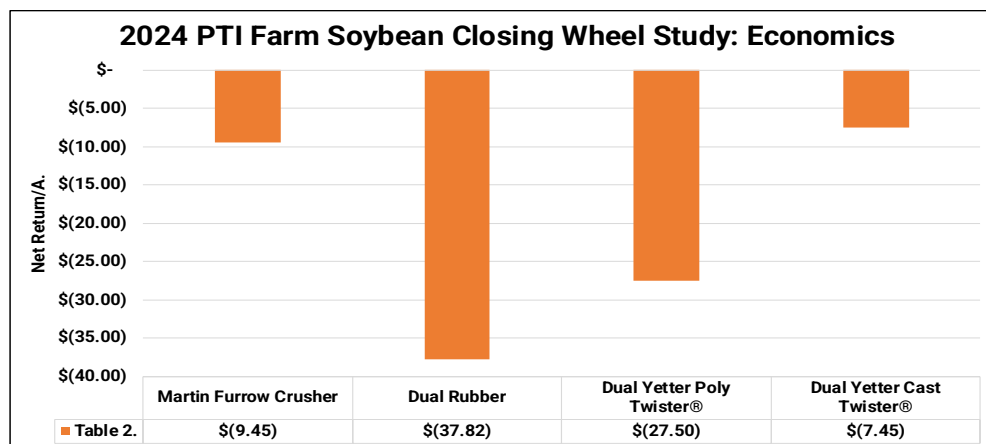
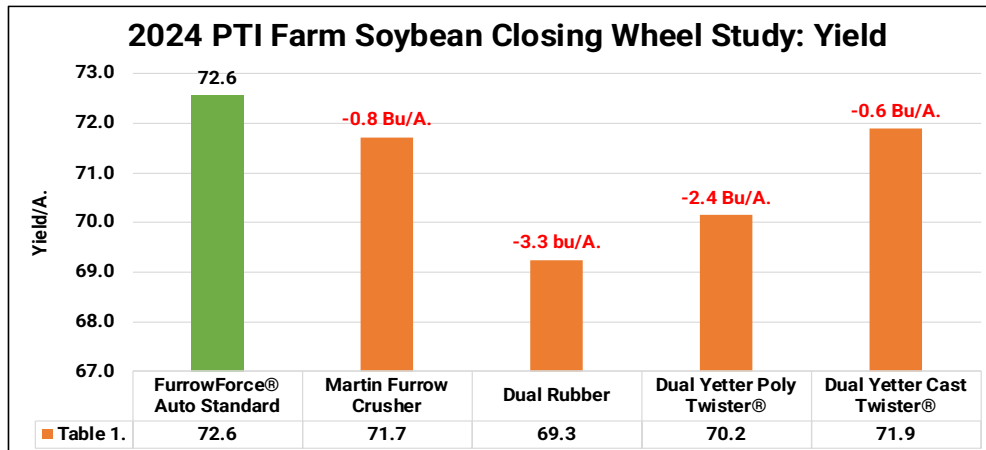

Planting Date: May 25<sup>th</sup>

Variety: Asgrow® 27XF3

Population: 130K

Row Width: 30"

Rotation: BAC

SB Price: \$11.46

## REVLIN® HOPPER THROTTLE™ Hopper Box Treatment Study

**Objective:** To evaluate yield and net return of REVLIN® HOPPER THROTTLE™.

HOPPER THROTTLE™ is a 80/20 talc graphic blend for planters that also contains Manganese, and Zinc. It places essential nutrition, flow agents, and crop enhancement components directly on the seed to aid in singulation and improve seedling vigor and growth.

**Results:** HOPPER THROTTLE™ hopper box treatments offered average yield gains of +2.0 Bu/A. with a average negative net return on investment of +\$9.69/A.

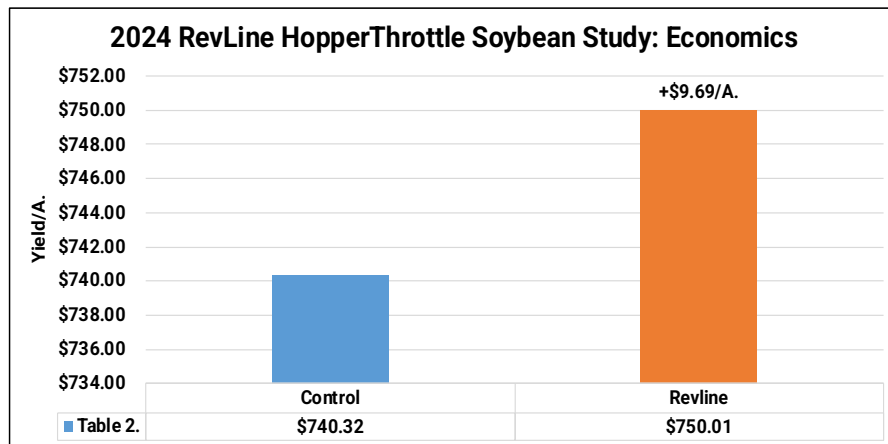
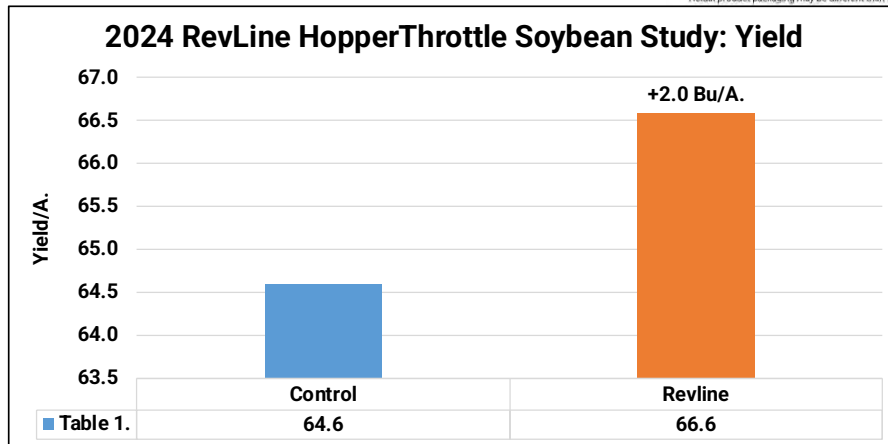
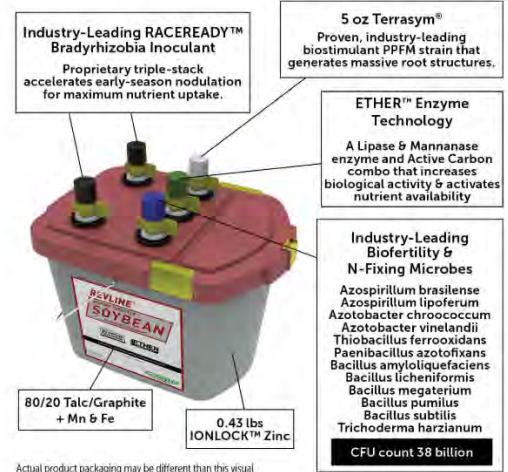

Planting Date: May 21<sup>st</sup> Variety: Asgrow 35XF3 Population: 26K Row Width: 30" Rotation: BAC Soybean Price: \$11.46 HOPPER THROTTLE: \$13.00 Talc/Graphite: \$0.15/A.

## Ridomil Gold® Granular Fungicide Study

**Objective:** To evaluate the yield and economic response of applying Ridomil Gold® at planting. Ridomil Gold® is a granular fungicide that provides systemic control of the soilborne diseases *Phytophthora* and *Pythium* in high-risk zones for soybeans.

Early-season outbreaks of pathogens can cause a reduction in yield potential, but in-furrow application of fungicides fights those stressors. It is difficult to predict when you will experience either cold, wet conditions or warm, wet conditions at or immediately after planting, but the areas that tend to develop disease pressures first are low-lying areas where water can pond or heavy soils where water retention is higher. This trial was implemented using a SIMPAS® in-furrow closed delivery system

**Results:** Planter applied treatments of Ridomil Gold® GR resulted in yield gains of +1.1 Bu/A. over the control applications. At a \$11.46 soybean commodity price and a product cost of \$10.39/A., economics netted +\$2.22/A.



Image 1. SIMPAS SmartCartridge®

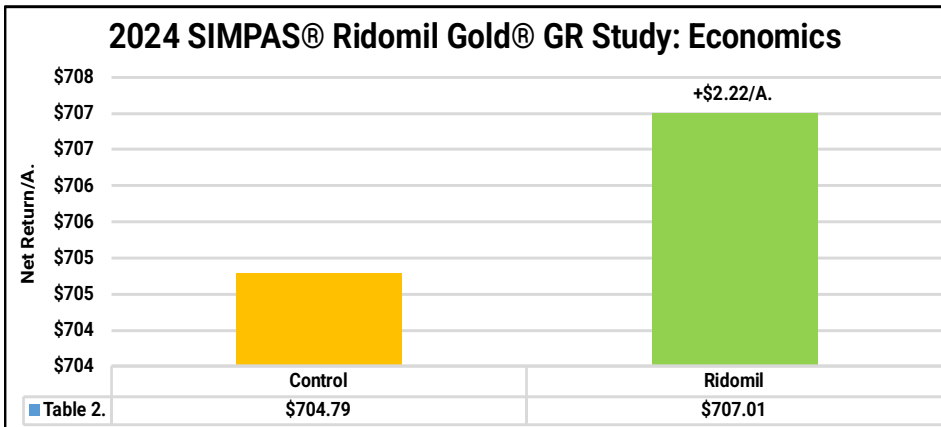
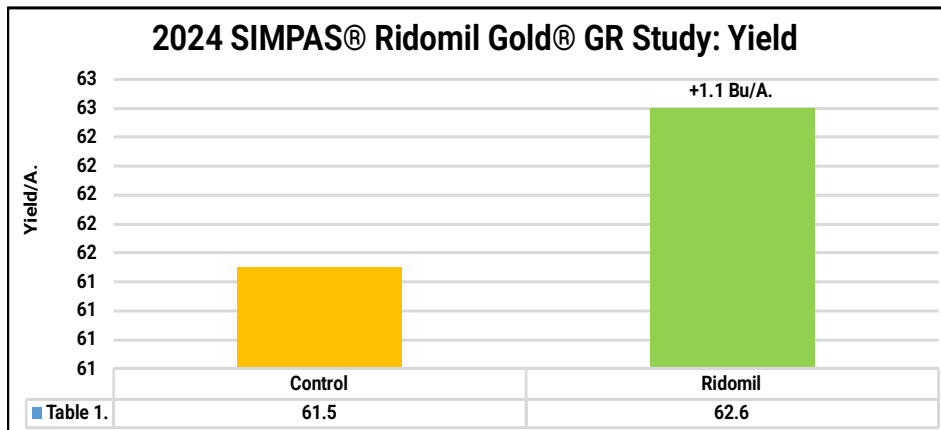

Planting Date: May 7<sup>th</sup> Variety: Asgrow 27XF3 Population: 130K Row Width: 30" Rotation: BAC Soybean Price: \$11.46 Ridomil Gold® GR: \$10.39/A.

## HyperSound Technology Seed Treatment Study

**Objective:** This trial evaluates the benefits and disadvantages of using HyperSound Technology as a seed treatment. HyperSound Technology by WISE LIFESTYLE is a process of changing the harmonic vibrations to offset the electromagnetic disturbances mobile radio and wireless communication generate.

A quantum field generator uses a femtosecond laser to irreversibly change and optimize the atomic structure (lattice) of crystalline matter such as certain metals and crystallized silicon dioxide. This charged metal begins to emit HyperSound frequencies which influences its environment and neutralizes existing electromagnetic disturbances.

**Results:** HyperSound treatments resulted in yield gains of +0.3 Bu/A and a positive net return on investment of +\$3.44/A.

Figure 1. Treating Seed With 6" HyperSound Egg

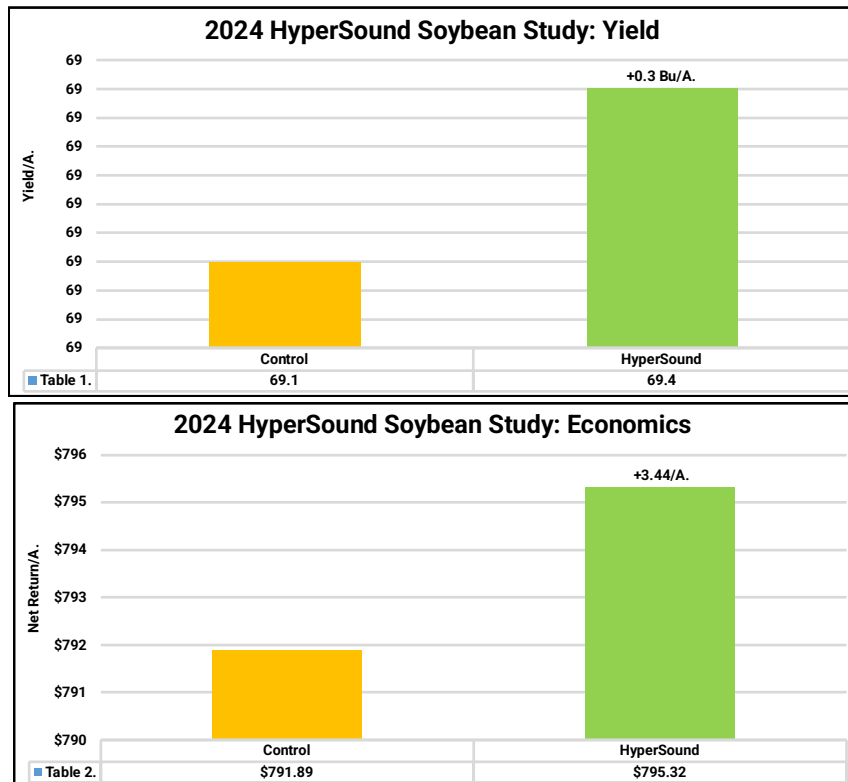

Planting Date: May 25<sup>th</sup>    Variety: Asgrow 27XF3    Population: 36K    Row Width: 30"    Rotation: CAB    Soybean Price: \$11.46

## Soybean Cover Crop Study:

**Objective:** This trial is designed to evaluate the yield and economic benefits of a cover crop system in a soybean/corn rotation. To evaluate long-term benefits, this trial has been designed as a 10-year study. 2024 is year 4 of the 10-yr trial.

20#/A. of a cereal ryegrass/barley mix was planted in the fall of 2023 (Figure 1.) and strip-till was then used as the primary tillage system after the ryegrass emerged. In the spring, soybeans were planted directly on the fall strips and into the green cover crop (Figure 2). Termination of the cover crop was implemented at when rye achieved 20" in height.

Figure 1. Fall Cover Crop Seeding



Figure 2. Planting on Strip-Till into Green Cover



## Soybean Cover Crop Study Continued

**Results:** Table 1. illustrates soybeans in the cover crop system proved +0.97 Bu/A. yield gains over the non-cover crop control.

Table 2. depicts net return on investment of the cover crop system. After the small yield gain and the cost of seed and planting, the cover crop system resulted in economic losses in 2024 of **-\$29.67/A.**

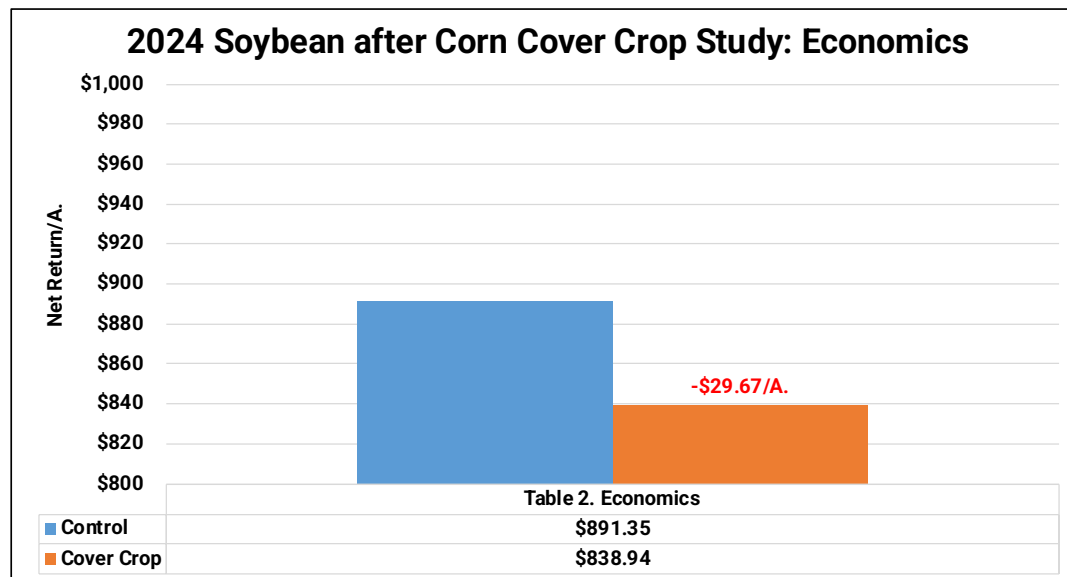
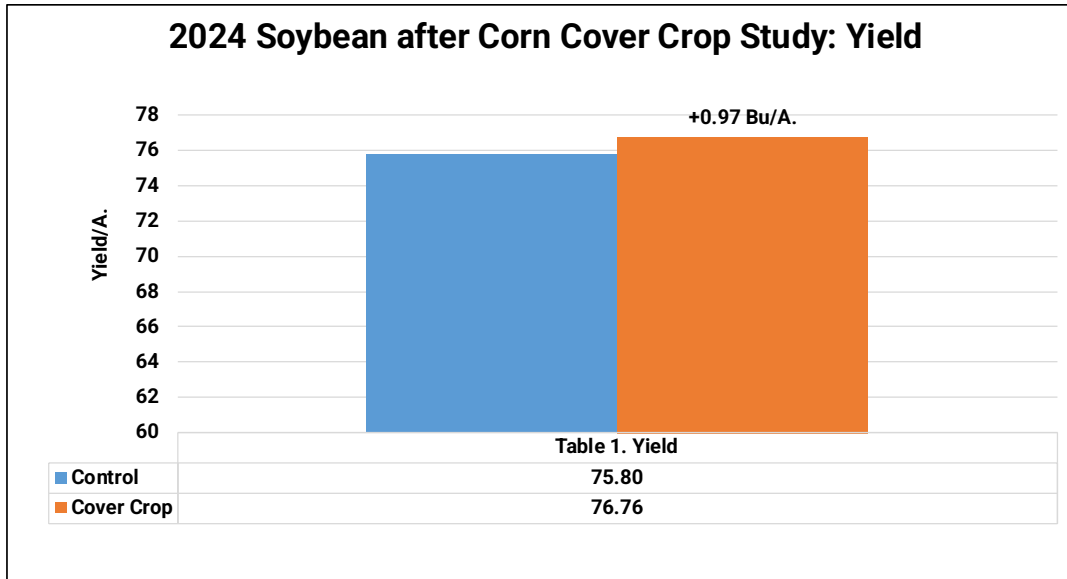

## Soybean Cover Crop Study Continued

At the PTI Farm, we believe we need to evaluate the performance of cover crops over time. As a 10-yr study this will allow us to measure annual average cash flow, along with hopefully the increase of soil health over time. Table 3. illustrates multi-year yield data and after three years of evaluating soybeans planted into a cover, yield losses today stand at **-2.33 Bu/A.**

More importantly, Table 4. explains the multi-year economics. Soybeans in a cover crop system at the PTI Farm have resulted in economic losses **-\$63.74/A.** thus far in three of our ten-year program.

It should be important to note that no program or subsidy cost reimbursements are calculated in this study. If a grower were to qualify for a program, it could help discount the cost of the cover program and help offset losses.

We look forward to continuing to test the use of cover crops in a soybean after corn rotation and to evaluate yield and

economics of the system, while taking a close look at what cover crops can offer regarding soil health improvement. While the PTI Farm has lower soil erosion concerns due to smaller degrees of slope, we are trying to understand other advantages that a cover crop system could add to favor farm sustainability.

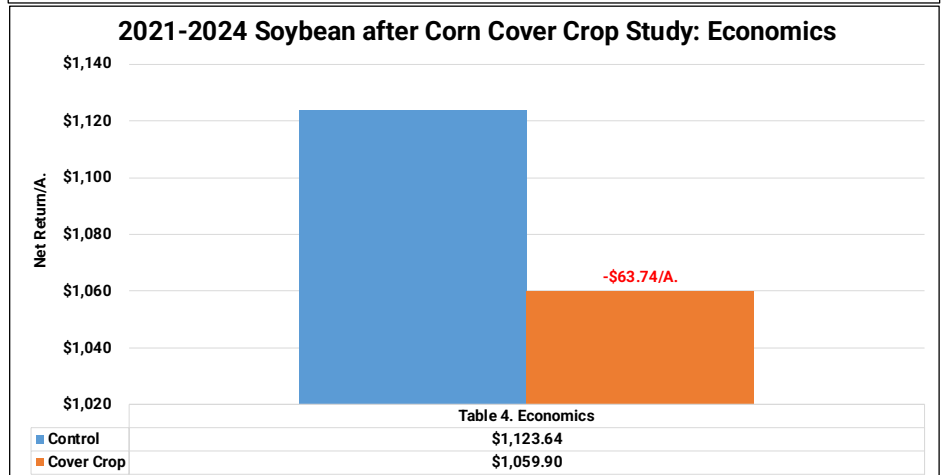
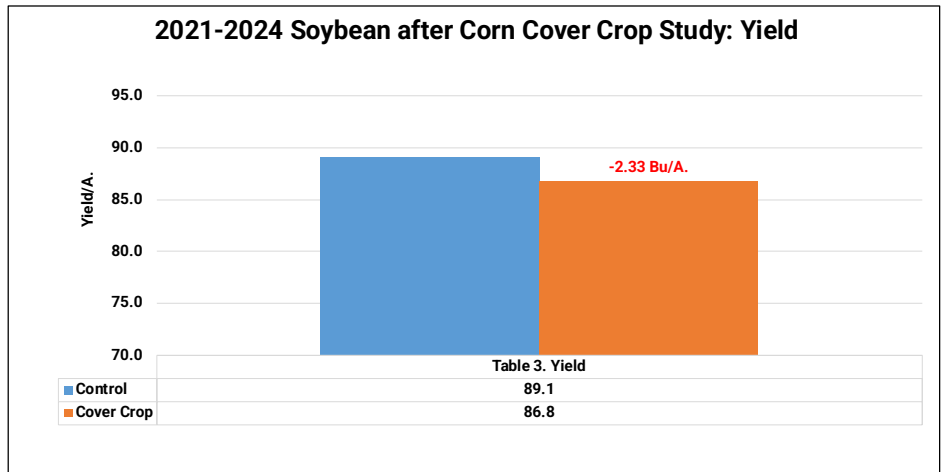



## Broadcast vs Banding Dry Fertilizer Study

**Objective:** To evaluate yield and economics of traditional broadcast applications of dry fertilizer compared to 8" deep high concentrated strip-till banding.

Based upon soil test results and yield goals of 70 Bu/A. soybeans in a corn/soybean non-irrigated rotation, 18-46-0 and 0-0-60 was applied in a traditional broadcast surface application made with a traditional spinner truck (Figure 1). Using the same fertilizer rates, a strip-till bar was used to place fertilizer in high concentrated strips 8" deep on 30" corn rows (Figure 2). A KUHN® Krause® Gladiator® pulling a Montag® Equipment 2208 Gen 2 fertilizer cart was used to implement this testing program for 2024.

**Results** Table 1. illustrates strip-till fertilizer in 2024, resulted in average yield gains of +1.7 Bu/A. over traditional broadcast applications.

Multi-year data suggests a +1.65 Bu/A. yield gain and equates to additional net returns of +\$9.88/A.

Figure 1. Broadcast Dry Fertilizer



Figure 2. Strip-Till Banded Fertilizer

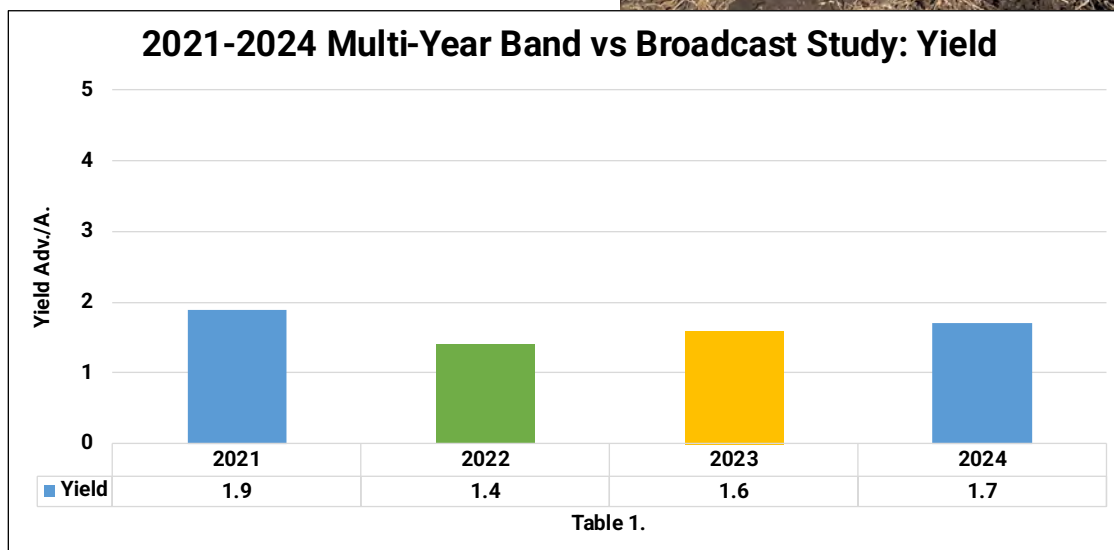

Planting Date: April 28<sup>th</sup>    Variety: Asgrow® 27XF3    Population: 130K    Row Width: 30"    Rotation: BAC    SB Price: \$11.46    Strip-Till: \$9.60/A.

## Broadcast vs Banding Rate Efficiency Study

**Objective:** To evaluate yield and economics of traditional broadcast applications of dry fertilizer compared to concentrated strip-till bands applied 8" in depth under the corn row.

To study placement efficiency, dry fertilizer was applied in a traditional broadcast surface application as a spinner truck (Figure 1.) and soybeans were planted into strip-till tillage program.

Using the same fertilizer rates, a strip-till bar was then used to place fertilizer in high concentrated strips 8" deep on 30" corn rows (Figure 2). Soybeans were then planted directly into those strips above the 8" fertilizer placement.

A KUHN® Krause® Gladiator® pulling a Montag® Equipment 2208 Gen 2 fertilizer cart was used to implement this testing program for 2024.

To then study rate efficiency, fertilizer was applied at the following rate structure in both strip-till bands and broadcast applications:

- ✓ 100% Fertilizer Rate
- ✓ 75% Fertilizer Rate
- ✓ 50% Fertilizer Rate
- ✓ 25% Fertilizer Rate
- ✓ 0# Rate

Figure 1. Broadcast Dry Fertilizer



Figure 2. Strip-Till Banded Fertilizer with Montag® cart



Figure 3. KUHN® Krause® strip-till unit



## Broadcast vs Banding Rate Efficiency Study Continued

**Results:** Table 1. summarizes overall average soybean yield at each fertilizer rate%. 100% rates offered highest yield advantage of +4.9 Bu/A. compared to 0% rates. 25%, 50%, and 75% fertilizer rates generated small advantages of only +1.4 to +1.6 Bu/A.

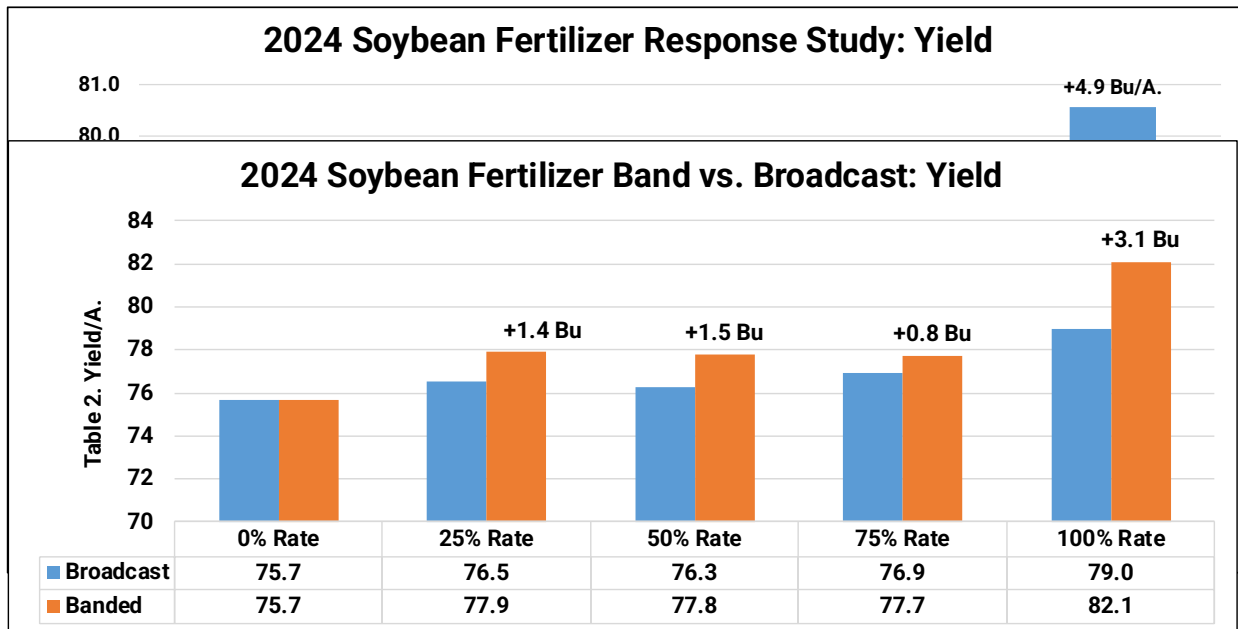

Table 2. illustrates that banding fertilizer out-performed broadcast applications at every rate percentage. Yield gains ranged from +0.8 to +3.1 Bu/A.

## Broadcast vs Banding Rate Efficiency Study Continued

Table 3. illustrates the net return of each banded fertilizer rate compared to traditional 100% broadcast applications. 75% rate bands resulted in net gains of +\$11.92/A., 50% bands +\$9.04/A. and 25% band +\$41.85/A. However, 0# of applied fertilizer achieved highest net returns of +\$66.13/A. In 2024, 0# of fertilizer proved to be the economic optimum fertilizer rate.

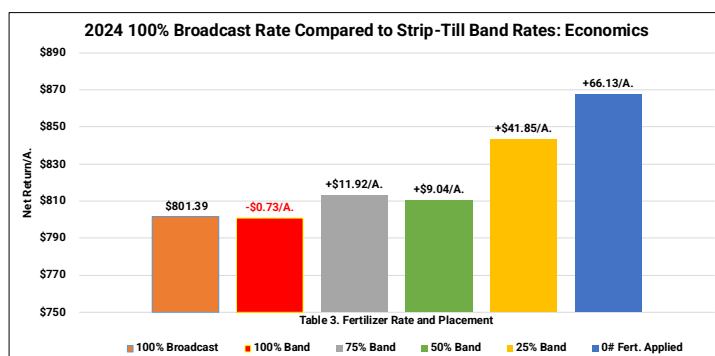
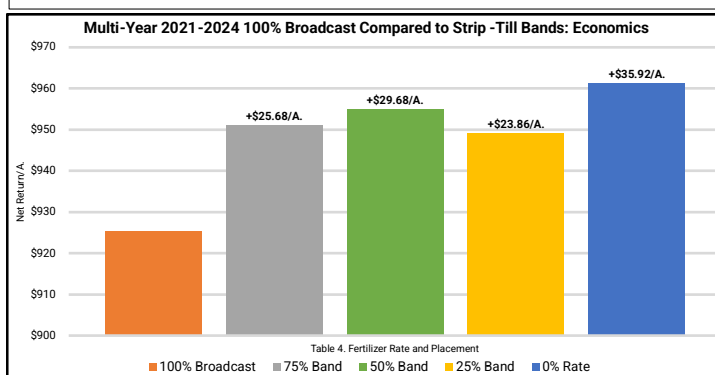
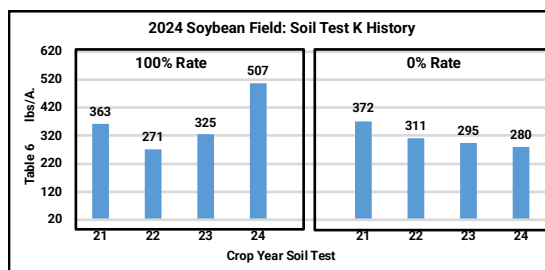
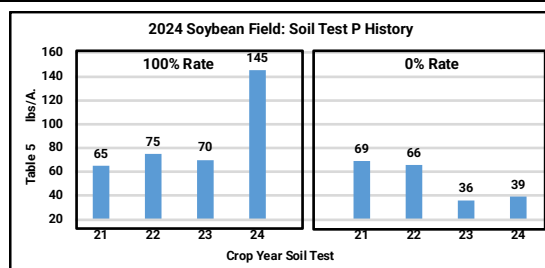

Table 4. summarizes multi-year data over 2021-2024. Banding 75%-25% rates of fertilizer have led to returns of +\$23.86 to +\$29.68/A. over traditional broadcast spreading. However, just as 2024 revealed, 0% rates have proven economic optimum at +\$35.92/A. In other words, over the last 4 years, applying 0# fertilizer made an additional +\$35.92/A. compared to 100% rates.



Tables 5-6 illustrate average soil P and K levels over the life of this 4-yr fertility study. 0% rates started at excellent of 69#/A. P and has decreased to 39# (-43%), which would be considered very low. Soil test K levels began at 372#/A. and has decreased to 280# (-25%), which would also be considered low. These values make it difficult to understand that under these low fertility levels, 0# of fertilizer would prove economic optimum? Given the high cost of dry fertilizer (\$635 DAP/\$445 Potash in 2024) it seems we have not received enough yield benefit to offset the cost.



As part of a 10-year study, this will be interesting to evaluate over the next 6-year period to analyze yield and economics as both fertilizer and commodity prices fluctuate.

## Mosaic® Sulfur/Boron Dry Fertilizer Study

**Objective:** To evaluate yield and net return of Mosaic® fertilizer products MicroEssentials® SZ™ and Aspire® to offer sulfur and boron in addition to traditional dry phosphorous and potassium fertilizer.

MicroEssentials® SZ™ is a 12-40-0-10S-1Zn and combines nitrogen, phosphorus, sulfur, and zinc into one nutritionally balanced granule, creating a single source for balanced crop nutrition. The unique chemistry and precise nutrient ratio of MicroEssentials® features; uniform nutrient distribution, increased nutrient uptake, and season long sulfur availability.

Formulated using Nutriform® technology, Aspire® is a 0-0-58 that provides two forms of boron (Sodium Borate 50% and Calcium Borate 50%) with potassium into a single granule for uniform nutrient distribution, season-long boron availability and flexible spring or fall application.

In this study, both Mosaic products are equivalently compared to traditional applications of 150#/A. of 18-46-0 DAP and 200#/A. of 0-0-60 potash as a control.



MicroEssentials <sup>®</sup> SZ <sup>™</sup>				
12	40	0	10	1
N	P <sub>2</sub> O <sub>5</sub>	K <sub>2</sub> O	S	Zn

Aspire <sup>®</sup>			
0	0	58	0.5
N	P <sub>2</sub> O <sub>5</sub>	K <sub>2</sub> O	B

## Mosaic® Sulfur/Boron Dry Fertilizer Study

Boron (B) is a micronutrient critical to the growth and health of all crops. It is a component of plant cell walls and reproductive structures. Boron, a water-soluble micronutrient, is especially prone to leaching. Since boron is a neutrally charged ion, it floats in ecosystems until it finds a substance to which it can bond to. During periods of heavy rain, boron is flushed out of the soil quickly. Boron serves two primary roles; one is supporting plant cell division, and the second is during the silking stage of development, in which boron helps transfer water and nutrients from the roots up through the plant. B is required in small amounts, in fact a 200 Bu/A. crop only uptakes 0.2lbs of B.

Sulfur (S) is an essential nutrient for corn growth and is a critical nutrient to make required proteins. One bushel of corn typically requires 0.1 to 0.12lbs/Bu. S uptake occurs over the entire growing season, with relatively constant uptake from the 14-leaf stage to maturity. Unlike nitrogen, only 40% to 50% of S is taken up by flowering. S is also very mobile in most soils, like nitrate, because it has a double negative charge and is repelled by the negative charge of the soil, unlike nutrients like potassium, calcium, or magnesium

**Results:** Mosaic® Micro-Essentials® SZ™ offered yield advantages of +2.0 Bu/A. over a traditional DAP program. These yield advantages equated to positive net returns of +\$10.10/A. after cost of product. ASPIRE® treatments replacing traditional potash offered yield advantages of +4.0 Bu/A., and equated to a net return of +\$21.41/A.

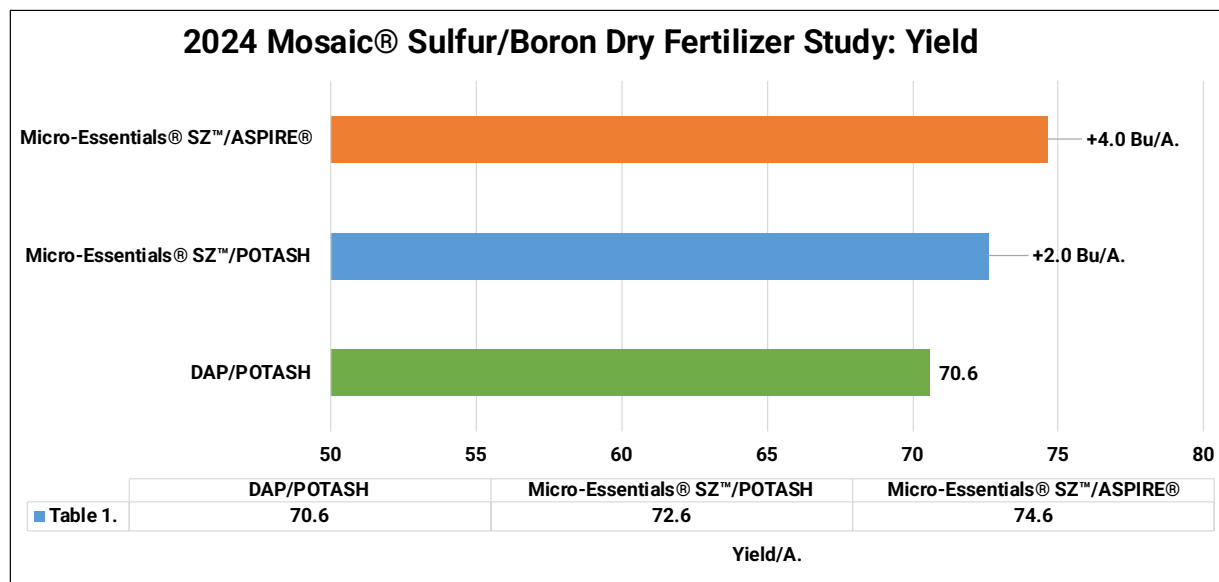

Planting Date: May 9<sup>th</sup>    Variety: Asgrow 27XF1    Population: 120K    Row Width: 30"    Rotation: BAC    Soybean Price: \$11.46    Mosaic SZ/ASPIRE: \$116.60/A.  
Mosaic SZ/POTASH: \$104.97/A.    DAP/POTASH: \$92.13/A.

## Liquid vs Dry Fertilizer Fall Strip-Till Study

**Objective:** To evaluate yield and economic impact of dry and liquid fertilizer programs in fall strip-till bands. This 2<sup>nd</sup> year study compares a traditional dry 18-46-0 and 0-0-60 fertilizer program versus a replacement liquid fertilizer program. Treatments were as follows:

<b><u>#1: 100% Dry Fertilizer Program:</u></b>	
150# 18-46-0 + 150# 0-0-60	
<b><u>#2: 50% Dry Fertilizer Program:</u></b>	
75# 18-46-0 + 75# 0-0-60	
<b><u>#3: 25% Dry Fertilizer Applied</u></b>	
37.5# 18-46-0 + 37.5# 0-0-60	
<b><u>#4: Control: No Fertilizer Applied</u></b>	
<b><u>#5: Liquid Fertilizer Program: 25% Nutrient Equivalent to Dry Program</u></b>	
6.25 Gal/A.	Nachurs® Throwback® 8-27-4-2S
10 Gal/A.	Nachurs® K-flex® 0-0-19-6S
<b><u>#6: Liquid Fertilizer Program: 50% Nutrient Equivalent to Dry Program</u></b>	
12.5 Gal/A.	Nachurs® Throwback® 8-27-4-2S
20 Gal/A.	Nachurs® K-flex® 0-0-19-6S
	
<b><u>#7: Liquid Fertilizer Program: 100% Nutrient Equivalent to Dry Program</u></b>	
25 Gal/A.	Nachurs® Throwback® 8-27-4-2S
40 Gal/A.	Nachurs® K-flex® 0-0-19-6S

## Liquid vs Dry Fertilizer Fall Strip-Till Study

All liquid treatments were applied in the Fall made with Black Eagle Ag Solution's strip-till unit.



This bar was fitted with Pump Stack® (Figure 1.), a liquid fertilizer hydraulic pump. It was paired with EMHD® and EM FlowSense™ (Figure 2.) to ensure a top-notch fertilizer application, as well as row control across the bar. EMHD® controls liquid application rates using an electromagnetic flow meter. This opens your options for a wider range of liquid products. EM FlowSense™ allows you to measure the rate of fertilizer you are applying on each row of the bar, to make you aware of any row-to-row variability that is occurring. With a Pump Stack® system, paired with EMHD®, and EM FlowSense™ you can be confident in your application rate across every row.



Figure 1. Pump Stack®



Figure 2. EMHD® + EM FlowSense™



## Liquid vs Dry Fertilizer Fall Strip-Till Study

**Results:** Table 1. illustrates our Control in this study of 0# fertilizer treatments resulted in soybean yield of 67.5 Bu/A. As we started to increase our rates of dry fertilizer to 25%, 50%, and 100%, yield increased. Dry 100% rate was the agronomic optimum at +9.6 Bu/A. As for the liquid rates, the 100% and 50% programs resulted in yield increases of +2.4 Bu/A., and +1.7 Bu/A. respectively. The 25% liquid fertilizer rate proved a agronomic loss of **-0.9 Bu/A.** compared to that of the control 0#.

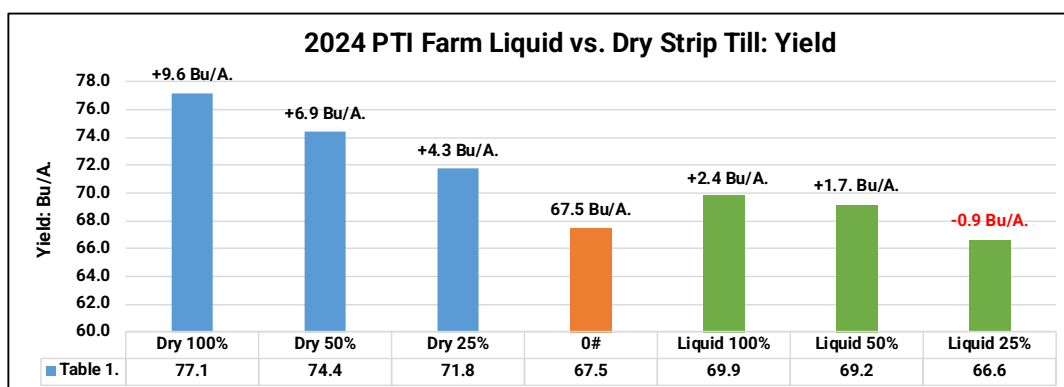
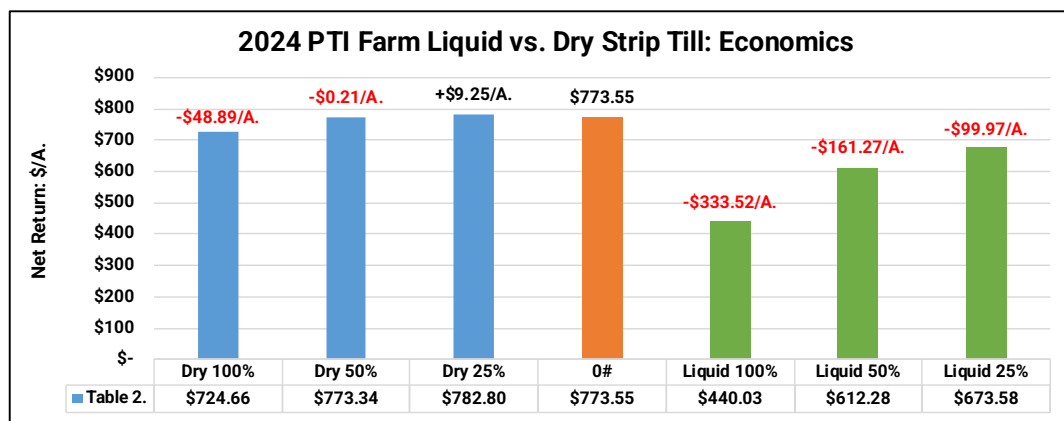

Table 2. reveals the overall economics of the fertilizer study and proved losses at all but one fertilizer rates. We endured significant losses at all the liquid fertilizer applications at **-\$99.97/A.** to **-\$333.52/A.** 100% and 50% dry rates of fertilizer also proved losses of **-\$0.21/A.** to **-\$48.89/A.**, while the only two entries to garner positive return on investment was the 25% dry, and 0# rate. Overall, the Black Eagle strip-till unit performed well regarding tillage. However, due to the high cost of fertilizer the liquid applications failed to achieve profitability of the dry program.



Planting Date: May 25<sup>th</sup>    Variety: Pro Harvest: APEX 3131E3    Population: 130K    Row Width: 30"    Rotation: BAC    SB Price: \$11.46

Liquid Program: 100% \$360.50/A, 50% \$180.25, 25% \$90.13    Dry Program: 100% \$159.00, 50% \$79.50/A., 25% \$39.75/A.    Avg Soil Test Level: P:59#/A. K: 375#/A.

## Calcium Products™ SO4™ Study

**Objective:** This trial evaluates the yield response and economics of pelletized calcium sulfate (SO4) applied fall broadcast and as banded spring strip-till. Sulfur is an essential component of plant growth with key processes relying on chlorophyll formation and protein production. Sulfur is considered the fourth major nutrient behind N, P, and K.



SO4™ from Calcium Products is a 21% Calcium (non-pH neutralizing) and 17% Sulfur dry pelletized fertilizer, mined, and manufactured in NW Iowa. It is finely ground and pelletized to achieve a balance of solubility and pellet strength.

Historically, much of the sulfur need was satisfied with atmospheric deposition as result of coal burning industries. However, amendments to the Clean Air Act in 1990 targeted sulfur emissions, resulting in less than ½ of the amount of sulfur today compared to 30 years ago.

**Results:** Banded strip-till applications of SO4 resulted in yield gains of +3.4 Bu/A. over the control. Banded SO4 achieved net returns of +\$5.02/A.

Multi-year data from 2022 and 2024 has proven +2.9 Bu/A. yield gains with positive return on investment of +\$6.19/A. on all strip-till banded applications of SO4.

### Releases Sulfur to Match Plant Needs

SO4 supplies a balanced initial sulfur release, and a steady supply through the growing season. AMS releases sulfur to quickly, and elemental sulfur releases sulfur to slowly, neither meeting the crop's complete needs.

### Spreads Easily

SO4 consistent pellet size allows it to be blended and applied with other dry fertilizers, which means it doesn't require a separate application. It can be applied pre-plant in the spring, in-season via top dress or post-harvest in the fall.

### Will Not Acidify Soil

SO4 is pH neutral, meaning it will not acidify the soil like other sulfur sources. Proper soil pH maximizes a plant's utilization of nutrients promoting good plant health and optimizing yield.

### 2024 PTI Farm SO4™ Study: Yield

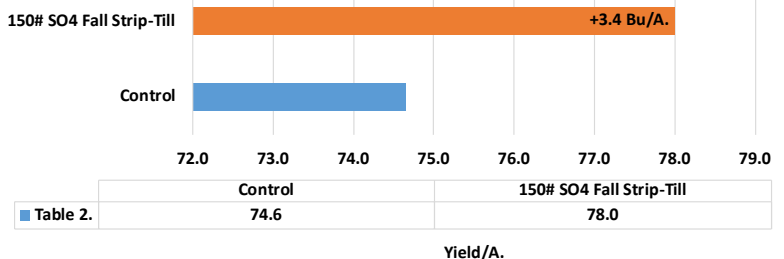

### 2024 PTI Farm SO4™ Study: Economics

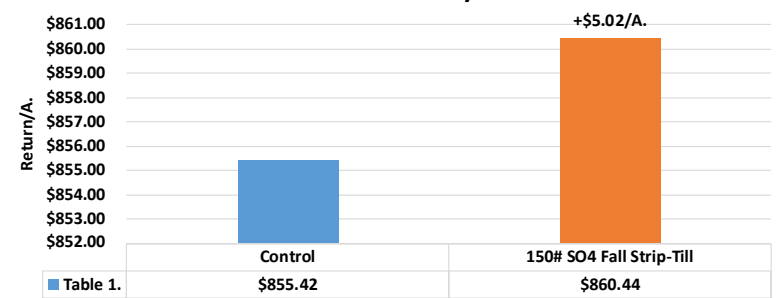

Planting Date: May 20<sup>th</sup> Variety: Asgrow 27XF3 Population: 130K Row Width: 30" Rotation: BAC Soybean Price: \$11.46 150#SO4: \$33.38/A. SO4:\$365/T+\$6App

## 2024 High Management Soybean: NETAFIM™ Irrigation Study

**Objective:** This study evaluates NETAFIM™ drip tape irrigation designed by NutraDrip Irrigation Systems and its' ability to feed soybeans with water and nutrients for high yield potential. This method of irrigating a crop uses NETAFIM™ drip tape with small pressure regulated emitters evenly spaced at 24" apart. Drip tape in this study is not sub-surface irrigation. It is rather installed on the soil surface to demonstrate how the system works, to growers who come to visit the PTI Farm. Water is accessed from a water recycling management program installed at the PTI Farm.



**Results:** In 2024, NETAFIM™ drip tape irrigation resulted in average yield increases of +32.3 Bu/A. compared to dryland soybeans. 5" of water was applied through drip irrigation throughout the growing season from June - September. 2024 yield response is the highest obtained in the 6-yr of drip irrigation at the PTI Farm.



Multi-Year data has proven irrigation to increase soybean yield by an average of 24.2 Bu/A., while increasing additional gross income by an average of +\$275.30/A.

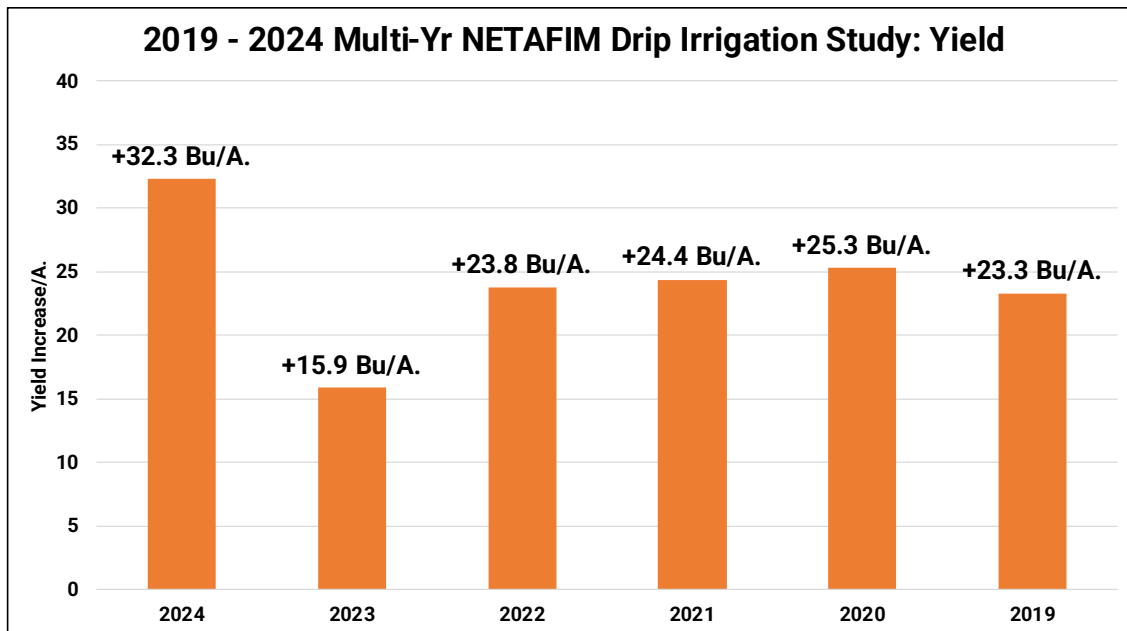

## 2024 High Management Soybeans: Soybean Seed Size Study

**Objective:** To evaluate soybean seed size in relation to high yield soybeans. In our 2024 high management soybean trials, our PTI Team wanted to evaluate the ability to increase soybean seed size, as a result of the various treatments applied throughout the growing season. Seed samples were collected at harvest and then ran through a series of seed counting and weighting exercises to determine actual seed weight and size (Figures 1-2).

**Results:** Table 1. summarizes the seed size differences of a high managed, irrigated protocol compared to that of a status quo, average management, dry land protocol.

Soybean seed sizes were 4.8% larger in high management treatments and also exhibited higher test weight by 2.7 #’s/Bu. More work needs to be done to fully understand soybean seed size from various management techniques, but 2024 data suggests bigger beans equates to bigger yields.

2021 data found high management soybeans averaging 2084 seeds/#, 27% larger than low management, 2022 averaged 2750 seeds/#, 14% larger, and 2023 data found high management soybeans averaging 2340 seeds/#, 16% larger.

Test weight is a “unicorn” to understand, but current overall volumetric grading standards in soybeans usually suggest average soybeans near 57#/Bu in most cases, even though farmers are graded at 60#/Bu.

Figure 1. Large Soybean Seed Size



Figure 2. Soybean Seed Counter



Table 1.

<b>Program:</b>	<b>Seed Size:</b>	<b>Test Weight:</b>	<b>Yield</b>
Status Quo:	3130 Seeds/#	56.4	71.9
High Management:	2725 Seeds/#	59.1	109.0

## Nachurs® High Management Irrigated Soybean Study

**Objective:** To evaluate the yield and economic impact of a soybean liquid starter fertilizer and foliar nutritional program from Nachurs® in a high management irrigated environment. This trial consisted of the following:

**Treatments and Placement:**

<b>#1. Control:</b>	150# Dap, 150# 0-0-60, R3 Miravis Neo
---------------------	---------------------------------------

<b>#2 At-Plant Fertility:</b>	
Conceal® Dual Band (Figure 1.)	3 Gal Nachurs Throwback®, 1 Gal K-flex Max
FurrowJet® Center: (Figure 2.)	1 Pt Rhyzo-Link® PE, 1 Qt Humi-Flex® FA, 1 Qt Microzone Ca
FurrowJet® Wings: (Figure 2.)	1 Qt Crop Max, 1 Gal Balance®, 1 Gal TripleOption®



<b>#3 Foliar Applications:</b>	
	V3: 1Qt FinishLine®, 1 Gal TripleOption®
	R1: 1 Gal Nachurs imPulse®, 1.5 Pt MoneyBall
	R3: 1.5 Gal NockOut®, 1 Qt Finishline®
	

Figure 1. Conceal® Placement



Figure 2. FurrowJet® Placement

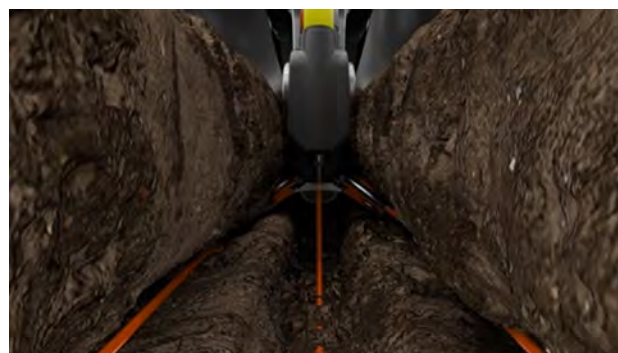

## Nachurs® High Management Irrigated Study Continued

**Results:** The table below illustrates control treatments averaging 89.5 Bu/A. At-plant treatments achieved 94.4 Bu/A., +4.9 Bu/A. over the control. At-plant + foliar treatments offered yields of 101.4 Bu/A., +11.9 Bu/A. gains over the control and +7.0 Bu/A. over the stand-alone at-plant treatments.

Economics indicate at-plant treatments resulted in gains of +\$45.52/A., while at-plant and foliar treatments gained additional positive returns with a net return of +\$64.81/A.

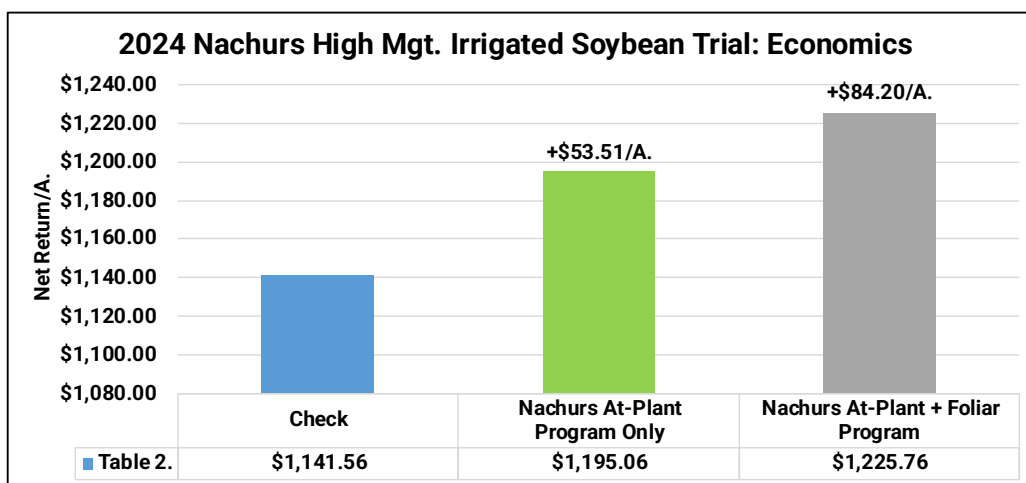
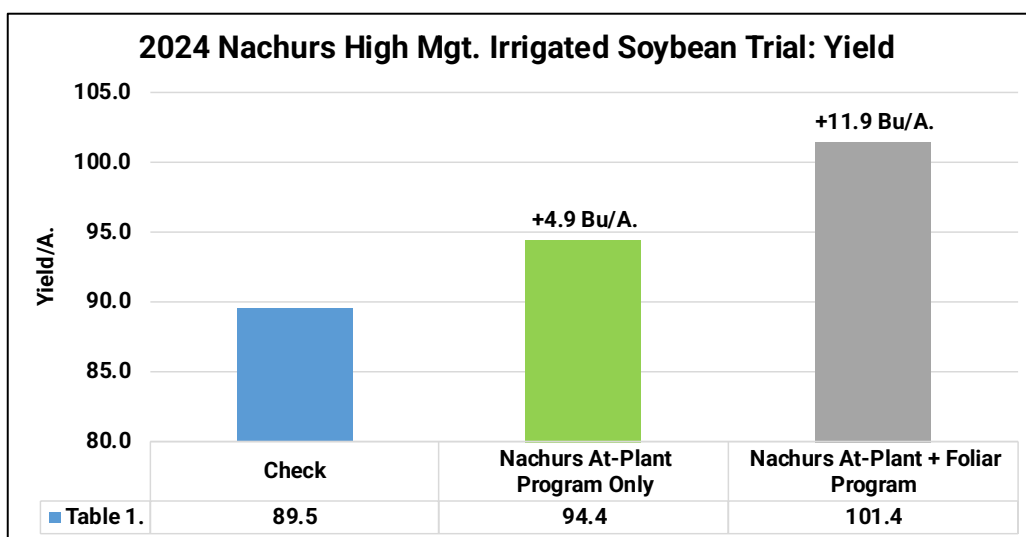

Planting Date: April 20<sup>th</sup>    Variety: Asgrow 33XF3    Population: 120K    Row Width: 30"    Rotation: BAC    SB Price: \$11.46

FurrowJet®: \$23.69/A    Conceal® Program: \$16.95/A.    Foliar Program: \$60.93/A.

## Nachurs® High Management Dryland Soybean Study

**Objective:** To evaluate the yield and economic impact of a soybean liquid starter fertilizer and foliar nutritional program from Nachurs® in a high management irrigated environment. This trial consisted of the following:

### Treatments and Placement:

#### #1. Control:

150# Dap, 150# Potash, R3 Miravis®Top

#### #2 At-Plant Fertility:

Conceal® Dual Band (Figure 1.)

3 Gal Nachurs Throwback®, 1 Gal Flex Max

FurrowJet® Center: (Figure 2.)

1 Pt Rhyzo-Link® PE, 1 Qt Humi-Flex® FA,  
1 Qt Microzone Ca

FurrowJet® Wings: (Figure 2.)

1 Qt Crop Max, 1 Gal Balance®, 1 Gal TripleOption®

#### #3 Foliar Applications:

V3: 1Qt FinishLine®, 1 Gal TripleOption®

R1: 1 Gal Nachurs imPulse®, 1.5 Pt MoneyBall

R3: 1.5 Gal NockOut®,  
1 Qt Finishline®



Figure 1. Conceal® Placement



Figure 2. FurrowJet® Placement

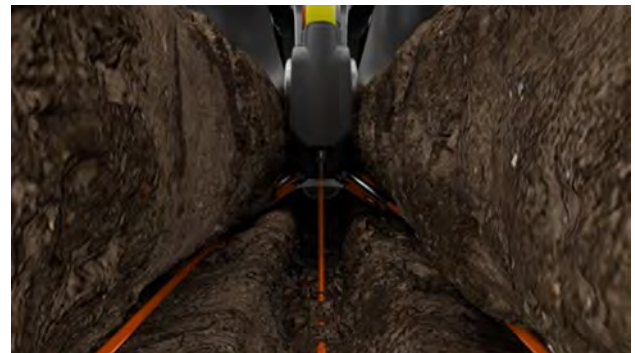

## Nachurs® High Management Dryland Study Continued

**Results:** The table below illustrates control treatments averaging 67.8 Bu/A. At-plant treatments achieved 70.6 Bu/A., +2.8 Bu/A. over the control. At-plant + foliar treatments offered yields of 76.1 Bu/A., +8.3 Bu/A. gains over the control and +5.5 Bu/A. over the stand-alone at-plant treatments.

Economics indicate at-plant treatments resulted in gains of +\$26.02/A., while at-plant and foliar treatments gained additional positive returns with a net return of +\$37.08/A.

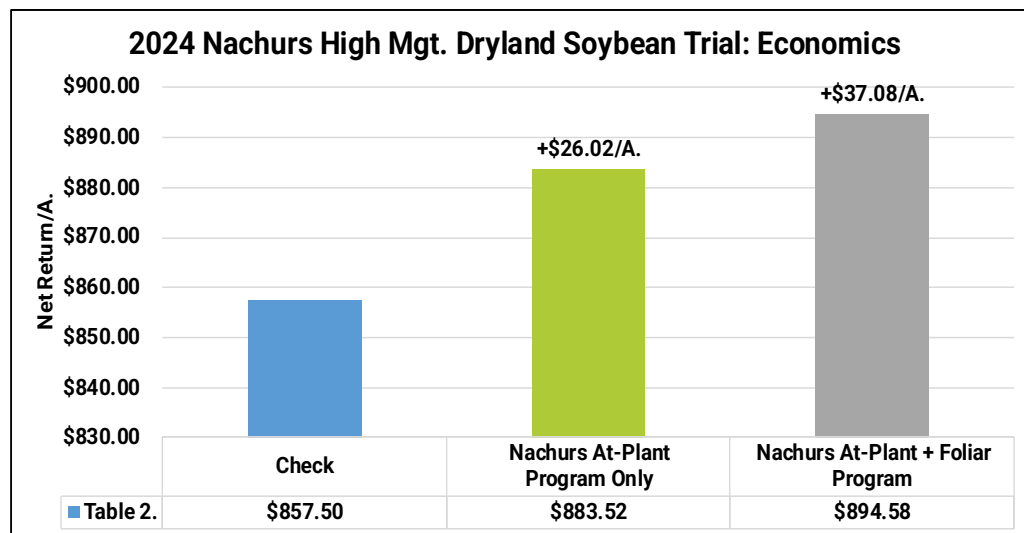
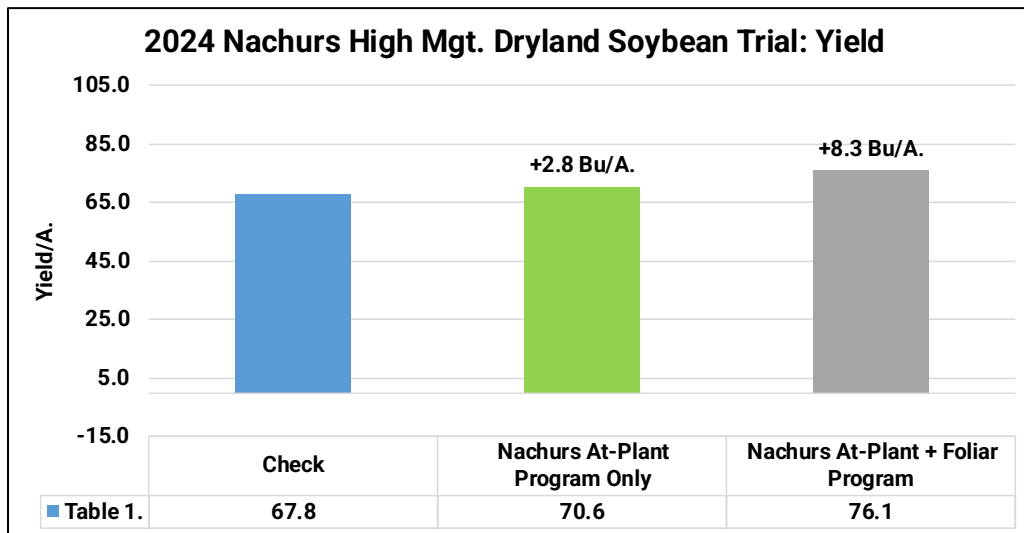

Planting Date: April 20<sup>th</sup>    Variety: Asgrow 33XF3    Population: 120K    Row Width: 30"    Rotation: BAC    SB Price: \$11.46

FurrowJet® Program: \$23.69/A    Conceal® Program: \$16.95/A.    Foliar Program: \$30.93/A.    Fungicide/App: \$30



## AgroLiquid® High Management Irrigated Soybean Study

**Objective:** To evaluate the yield and economic impact of a soybean liquid starter fertilizer and foliar nutritional program from AgroLiquid in a high management irrigated environment. This trial consisted of the following:

**Treatments and Placement:**

<b>Control:</b>	150# DAP, 150# Potash, R3 Miravis®Top
<b>At-Plant Fertility:</b>	
FurrowJet® Center: (Figure 1.)	1 Gal/A. Pro-Germ® 2 Gal/A. Sure-K™
FurrowJet® Wings (Figure 1.)	0.5 Gal/A. Micro500™ 0.5 Gal/A. LiberateCa® 0.25 Gal/A. eNhance™
Conceal® Dual Band (Figure 2.)	3 Gal/A. accesS®

<b>Foliar Applications:</b>	V4: 1 Gal/A. SureK™ + .125 Gal Manganese, .125 Gal/A. Boron®, 1 Gal/A. FertiRain®
	R1: 1 Gal/A. SureK™ + .125 Gal Manganese, .125 Gal/A. Boron®, 1 Gal/A. FertiRain®

Figure 1. FurrowJet® Placement



Figure 2. Conceal® Dual Band Application



## AgroLiquid® High Management Irrigated Soybean Study.

Irrigated treatments received 5.00" of rain throughout the growing season, and all treatments received fungicide applications of 13.7oz/A. Miravis® Top at R1 and 13.7oz/A. of Miravis®Neo at R3 growth stages. Control treatments received 100# DAP and 100# Potash for its dry fertility program.

**Results:** At-Plant FurrowJet® and Conceal® treatments resulted in yields of 102.6 Bu/A., +6.6 Bu/A. over the control. At-plant + foliar combination treatments pushed yield to 105.3 Bu/A., +9.3 Bu/A. over the control.

After all costs, at-plant nutritional treatments proved economic gains of +\$34.46/A. Adding the foliar treatments to at-plant applications tallied economic gains of +\$21.52/A.

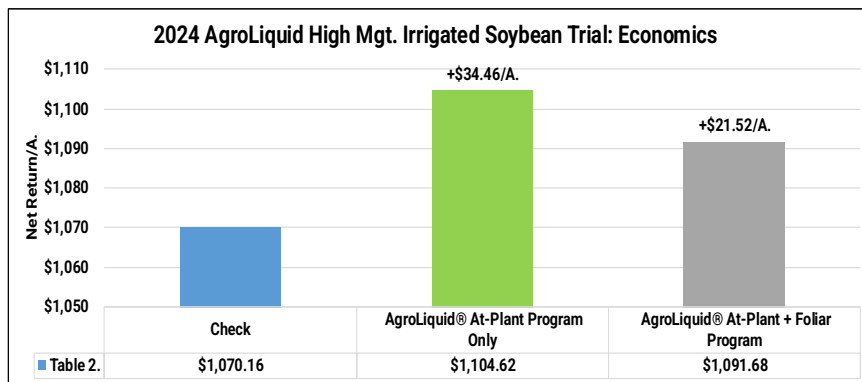
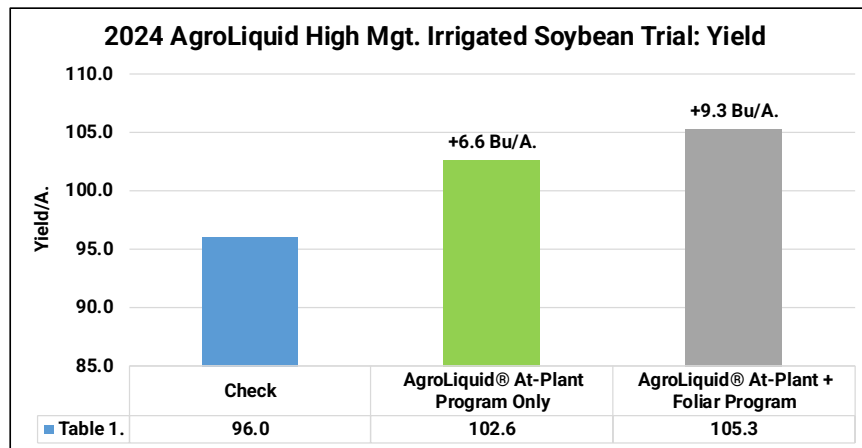

Planting Date: April 13<sup>th</sup> Variety: Pioneer37A18E3 Population: 120K Row Width: 30" Rotation: BAC SB Price: \$11.46

At-Plant Program: \$71.18/A. Foliar Program: \$43.88/A Fert Reallocation: \$30/A.

## AgroLiquid® High Management Dryland Soybean Study

**Objective:** To evaluate the yield and economic impact of a soybean liquid starter fertilizer and foliar nutritional program from AgroLiquid in a high management Dryland environment. This trial consisted of the following:

### Treatments and Placement:

<b>Control:</b>	150# DAP, 150# Potash, R3 Miravis®Top
<b>At-Plant Fertility:</b>	
FurrowJet® Center: (Figure 1.)	1 Gal/A. Pro-Germ® 2 Gal/A. Sure-K®
FurrowJet® Wings (Figure 1.)	0.5 Gal/A. Micro500™ 0.5 Gal/A. LiberateCa®  0.25 Gal/A. eNhance
Conceal® Dual Band (Figure 2.)	3 Gal/A. accesS®

### Foliar Applications:

V4: 1 Gal/A. SureK + .125 Gal Manganese,  
.125 Gal Boron®, 1 Gal/A. FertiRain®

R1: 1 Gal/A. SureK + .125 Gal Manganese,  
125 Gal Boron®, 1 Gal/A. FertiRain®



Figure 1. FurrowJet® Placement



Figure 2. Conceal® Dual Band Application



## AgroLiquid® High Management Dryland Soybean Study.

**Results:** : At-Plant FurrowJet® and Conceal® treatments resulted in yields of 71.7 Bu/A., +4.5 Bu/A. over the control. At-plant + foliar combination treatments pushed yield to 74.9 Bu/A., +7.7 Bu/A. over the control.

After all costs, at-plant nutritional treatments proved economic gains of +\$10.39/A. Adding the foliar treatments to at-plant applications tallied economic losses of +\$3.18/A.

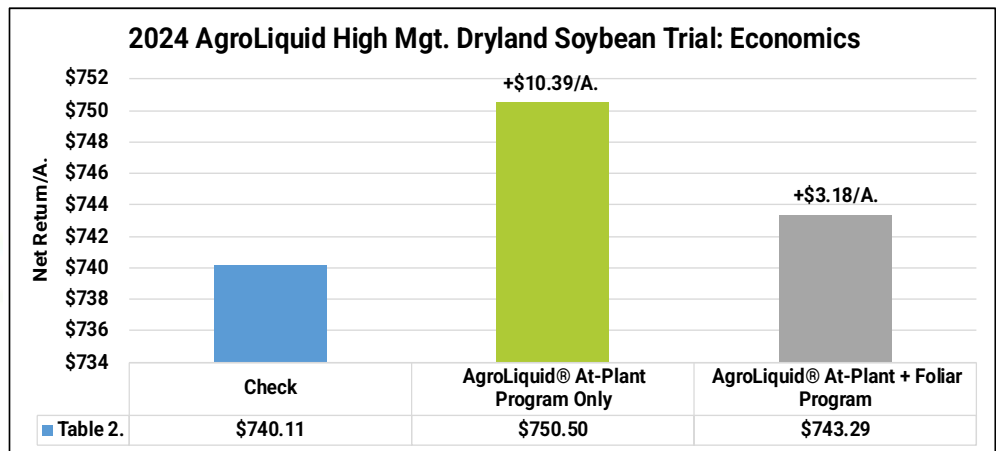
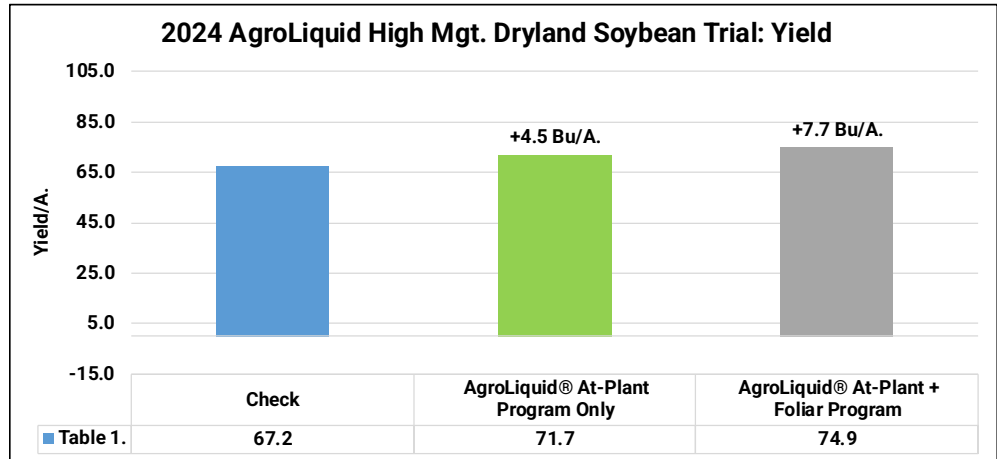

Planting Date: April 13<sup>th</sup>    Variety: Pioneer 37A18E3    Population: 120K    Row Width: 30"    Rotation: BAC    SB Price: \$11.46

At-Plant Program: \$71.18/A.    Foliar Program: \$43.88/A.    Fert Reallocation: \$30/A.

## Marco Fertilizer High Management Irrigated Soybean Study

**Objective:** To evaluate the yield and economic impact of a soybean liquid starter fertilizer and foliar nutritional program from Marco Fertilizer in a high management irrigated environment. This trial consisted of the following:

### Treatments and Placement:

<b>#1. Control:</b>	150# 18-46-0,125# 0-0-60, R1 Miravis®Top
<b>#2 At-Plant Fertility:</b>	
Conceal® Dual Band (Figure 1.)	1 Pt Soil Assist 3 Gal QuickGrow Complete
FurrowJet® Wings: (Figure 2.)	1 oz MycoBoost
<b>#3 Foliar Applications:</b>	
	V3: 20 oz Energizer, 1 Pt Iron Plus
	R1: 2# Nutri Complete, 2oz Poseidon, 1 Pt Energizer, 1 Qt Calcium Plus
	R4: 2.5 Gal Finisher

Figure 1. Conceal® Placement



Figure 2. FurrowJet® Placement

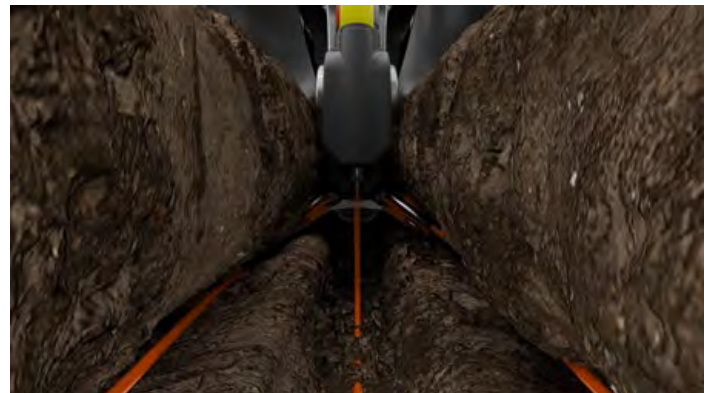

## Marco Fertilizer High Management Irrigated Soybean Study

Irrigation consisted of 5.00" of rain throughout the growing season and all treatments received fungicide applications of 13.7oz/A. Miravis® Top at R1 and 13.7oz/A. Miravis®Neo at R3 growth stages.

**Results:** At-Plant FurrowJet® and Conceal® treatments resulted in yields of 93 Bu/A., +5.2 Bu/A. over the control. At-plant + foliar combination treatments pushed yield to 95 Bu/A., +7.2 Bu/A. over the control.

After all costs, at-plant nutritional treatments proved economic gains of +\$52.77/A. Adding the foliar treatments to at-plant applications tallied economic gains of +\$34.19/A.

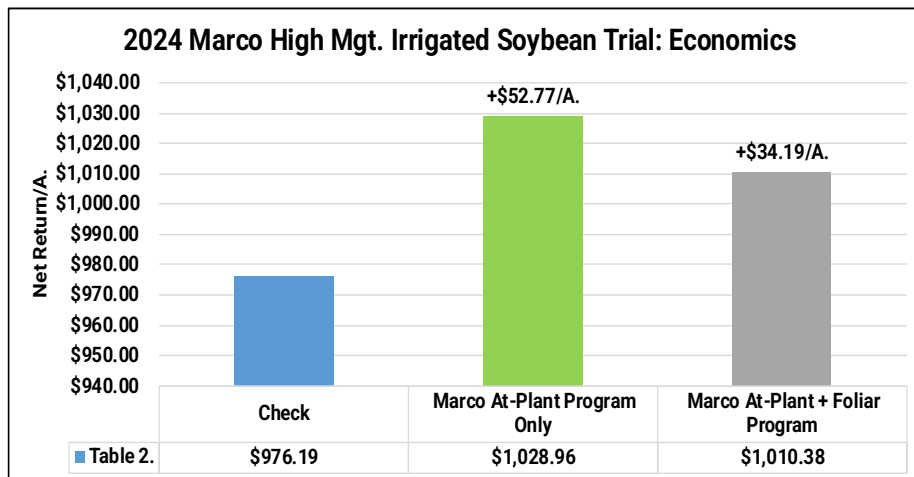
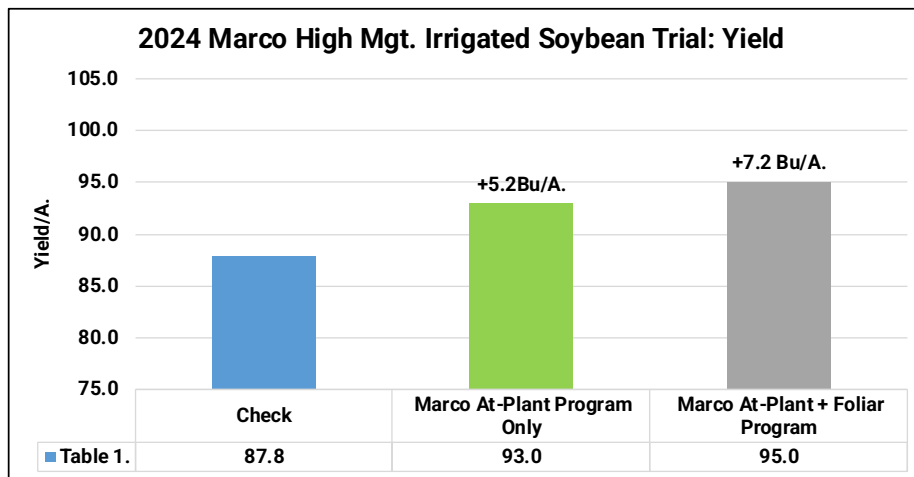

Planting Date: May 9<sup>th</sup> Variety: GH 3035E3 Population: 120K Row Width: 30 Rotation: BAC SB Price: \$11.46 Irrigation: \$40/A.

At-Plant Program: \$36.83/A. Foliar Program: \$41.50/A \$30 Fert Reallocation

## Marco Fertilizer High Management Dryland Soybean Study

**Objective:** To evaluate the yield and economic impact of a soybean liquid starter fertilizer and foliar nutritional program from Marco Fertilizer in a high management irrigated environment. This trial consisted of the following:

### Treatments and Placement:

<b>#1. Control:</b>	150# 18-46-0, 150# 0-0-60, R3 Miravis®Top
---------------------	---

### #2 At-Plant Fertility:

Conceal® Dual Band (Figure 1.)	1 Pt Soil Assist 3 Gal QuickGrow Complete
FurrowJet® Wings: (Figure 2.)	1 oz MycoBoost

### #3 Foliar Applications:



V3: 20 oz Energizer, 1 Pt Iron Plus  
R1: 2# NutriComplete, 2oz Poseidon,  
1 Pt Energizer, 1 Qt Calcium Plus  
R4: 2.5 Gal Finisher

Figure 1. Conceal® Placement

**Marco**

Figure 2. FurrowJet® Placement

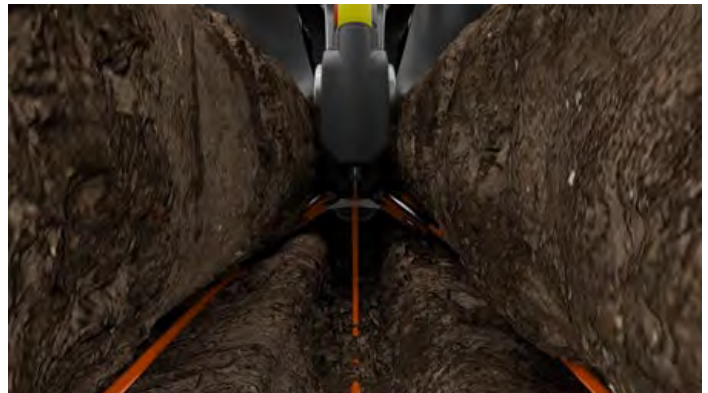

## Fertilizer High Management Dryland Soybean Study.

Irrigation consisted of 5.00" of rain throughout the growing season, and all treatments received fungicide applications of 13.7oz/A. Miravis® Top at R1 and 13.7oz/A. Miravis®Neo at R3 growth stages.

**Results:** : At-Plant FurrowJet® and Conceal® treatments resulted in yields of 72.5 Bu/A., +3.4 Bu/A. over the control. At-plant + foliar combination treatments pushed yield to 74.9 Bu/A., +5.8 Bu/A. over the control.

After all costs, at-plant nutritional treatments proved economic gains of +\$32.14/A. Adding the foliar treatments to at-plant applications tallied economic gains of +\$18.14/A.

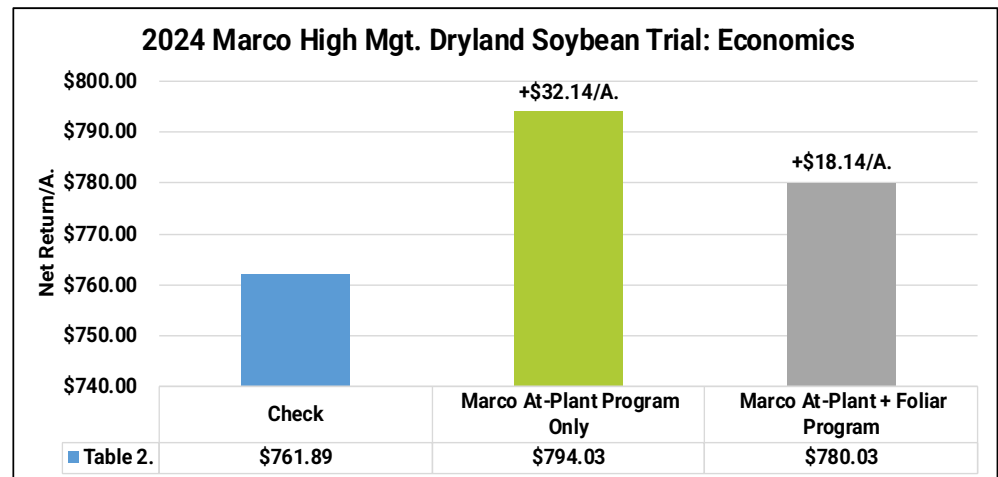
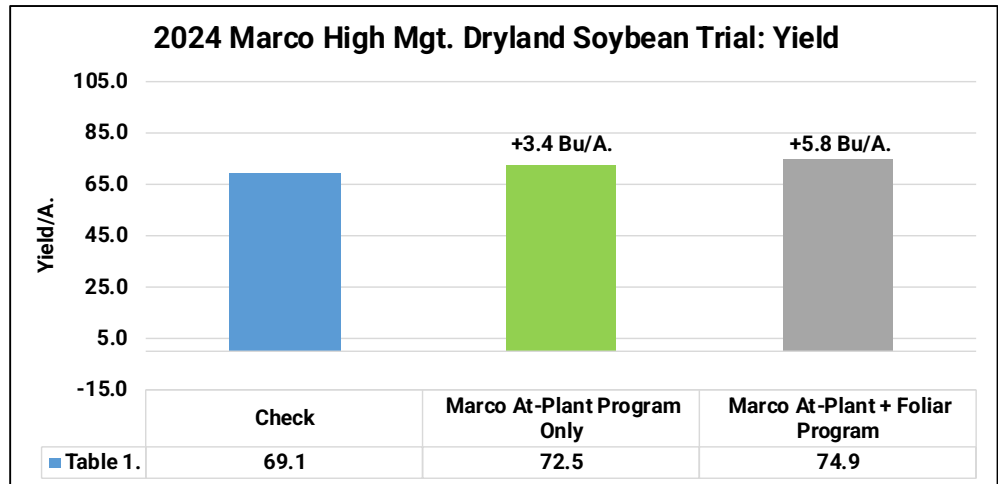

Planting Date: April 13<sup>th</sup>    Variety: GH 3035E    Population: 120K    Row Width: 30"    Rotation: BAC    SB Price: \$11.46

At-Plant Program: \$36.83/A.    Foliar Program: \$41.50/A.    \$30 Fert Reallocation



## QLF® High Management Irrigated Soybean Study

**Objective:** To evaluate the yield and economic impact of a soybean liquid starter fertilizer and foliar nutritional program from QLF in a high management irrigated environment. This trial consisted of the following:

### Treatments and Placement:

<b>Control:</b>	150# 18-46-0, 150# 0-0-60. R1 Miravis®Top
<b>At-Plant Fertility:</b>	
FurrowJet® Center: (Figure 1.)	3 Gal/A. L-CBF 5-5-5-1S
FurrowJet® Wings: (Figure 1.)	1 Qt/A. CornSpike 1 Pt/A. Kelpak
Conceal® Dual Band (Figure 2.)	2 Gal/A. BOOST + 1 Qt/A. PowerAid 1Pt/A. Kelpak+ 8 Gal/A. Marco Boost
<b>Post Plant Applications:</b>	
	V3: 2 Gal/A. Boost + 1 Pt/A. PowerAid + 1Pt/A. Kelpak
	V8: 2 Gal/A. Boost + 1 Pt/A. PowerAid + 1Pt/A. Kelpak
	R3: 3 Gal/A. 5-5-5-1S
	R5: 3 Gal/A. 5-5-5-1S

Figure 1. FurrowJet® Placement

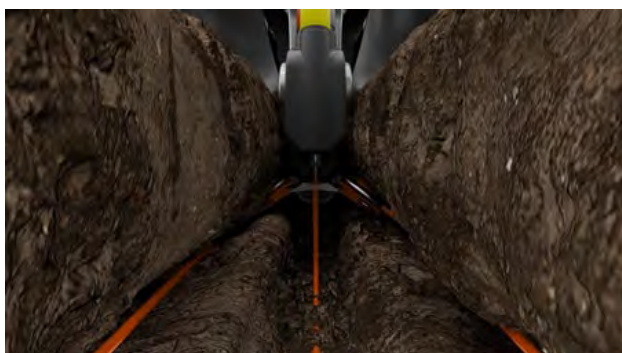

Figure 2. Conceal® Dual Band Application



## QLF® High Management Irrigated Soybean Study.

Irrigation consisted of 5.00" of rain throughout the growing season, and all treatments received fungicide applications of 13.7oz/A. Miravis® Top at R1 and 13.7oz/A. Miravis®Neo at R3 growth stages.

**Results:** The table below illustrates control treatments averaging 99.2 Bu/A. At-plant treatments achieved 103.6 Bu/A., +4.4 Bu/A. over the control. At-plant + foliar treatments offered yields of 106.1 Bu/A., +6.9 Bu/A. gains over the control and +2.5 Bu/A. over the stand-alone at-plant treatments.

Economics indicate at-plant treatments resulted in gains of +\$18.19/A., while the addition of the foliar treatments to the at-plant program resulted in negative returns with a net return of **-\$7.38/A.**

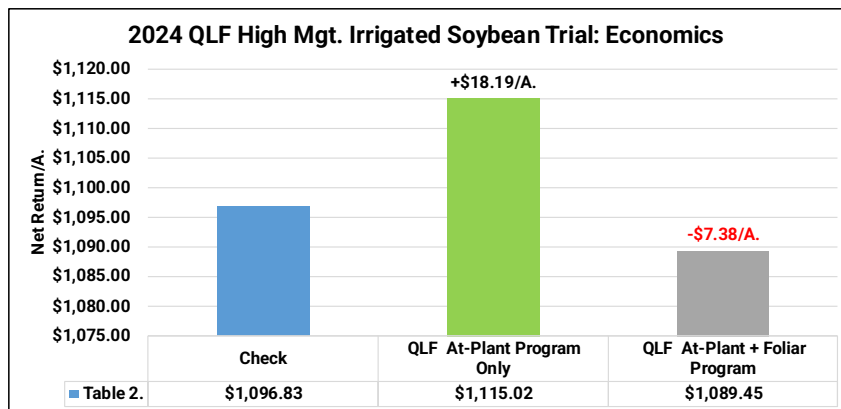
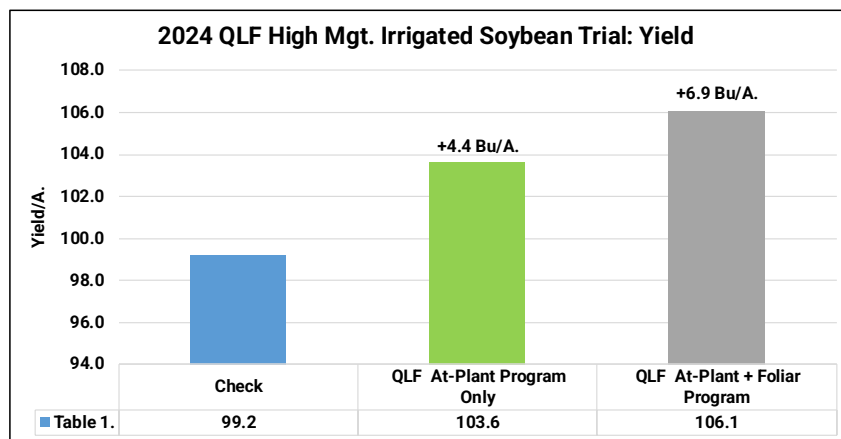

Planting Date: May 20<sup>th</sup> Variety: ProHarvest Apex 3131E3 Population: 36K Row Width: 30" Rotation: BAC Soybean Price: \$11.46

Seed Program: \$4.57/A Planter Program: \$67.66/A. Foliar Program: \$54.23/A. Fert Reallocation: \$40/A.

## QLF® High Management Dryland Soybean Study

**Objective:** To evaluate the yield and economic impact of a soybean liquid starter fertilizer and foliar nutritional program from QLF in a high management irrigated environment. This trial consisted of the following:

### Treatments and Placement:

<b>Control:</b>	150# 18-46-0, 150# 0-0-60, R1 Miravis®Top
<b>At-Plant Fertility:</b>	
FurrowJet® Center: (Figure 1.)	3 Gal/A. L-CBF 5-5-5-1S
FurrowJet® Wings: (Figure 1.)	1 Qt/A. CornSpike 1 Pt/A. Kelpak
Conceal® Dual Band (Figure 2.)	2 Gal/A. BOOST + 1 Qt/A. PowerAid 1Pt/A. Kelpak+ 8 Gal/A. Marco Boost
<b>Post Plant Applications:</b>	
	V3: 2 Gal/A. Boost + 1 Pt/A. PowerAid + 1Pt/A. Kelpak
	V8: 2 Gal/A. Boost + 1 Pt/A. PowerAid + 1Pt/A. Kelpak
	R3: 3 Gal/A. 5-5-5-1S
	R5: 3 Gal/A. 5-5-5-1S
<p>All treatments received fungicide applications of 13.7oz/A. Miravis® Top at R1 and 13.7oz/A. Miravis®Neo at R3 growth stages.</p>	

Figure 1. FurrowJet® Placement



Figure 2. Conceal® Dual Band



## QLF® High Management Dryland Soybean Study

**Results:** The table below illustrates control treatments averaging 74.8 Bu/A. At-plant treatments achieved 77.9 Bu/A., +3.1 Bu/A. over the control. At-plant + foliar treatments offered yields of 81.3 Bu/A., +6.5 Bu/A. gains over the control and +3.4 Bu/A. over the stand-alone at-plant treatments.

Economics indicate at-plant treatments resulted in gains of +\$3.29/A., while the addition of the foliar treatments to the at-plant program resulted in negative returns with a net return of **-\$11.97/A.**

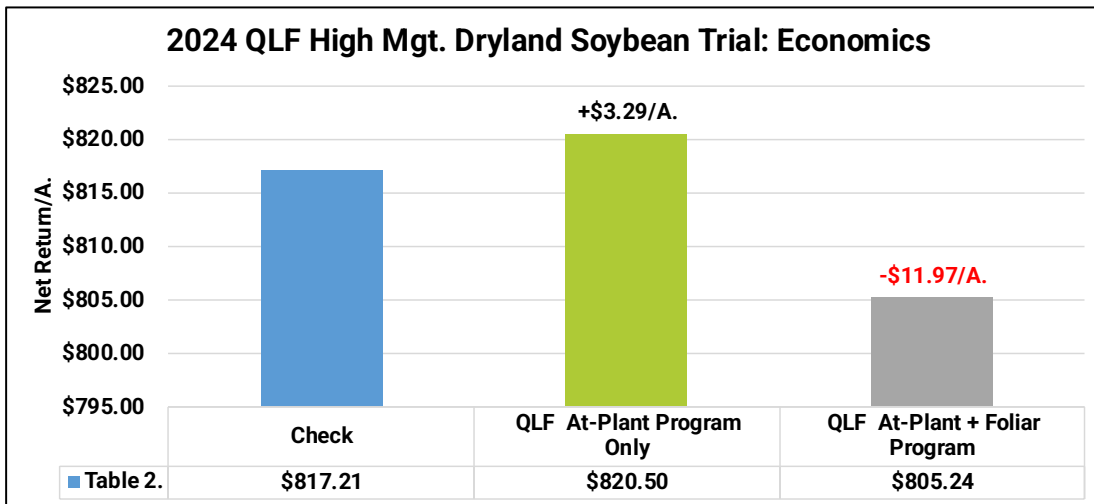
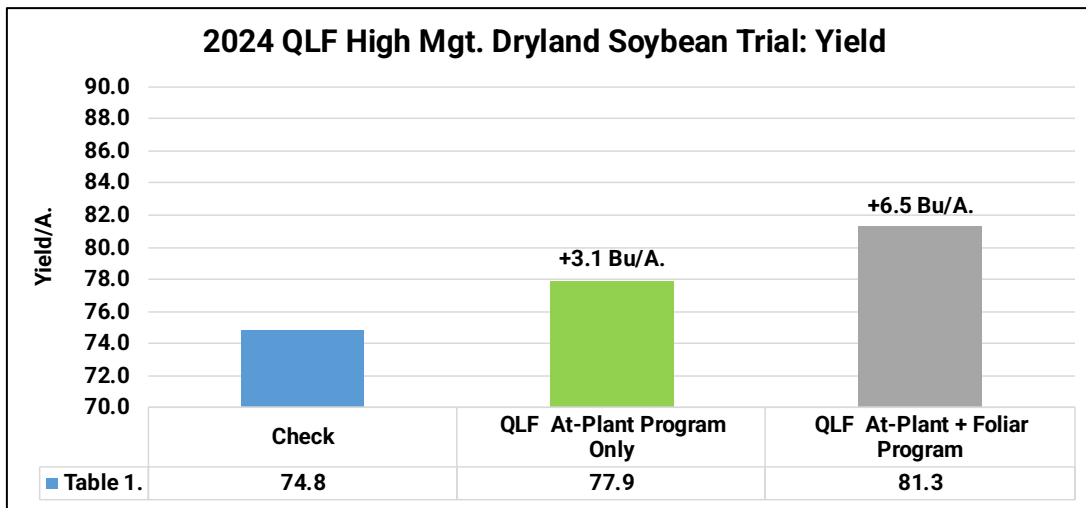

Planting Date: May 20<sup>th</sup> Variety: ProHarvest Apex 3131E3 Population: 36K Row Width: 30" Rotation: BAC Soybean Price: \$11.46

Seed Program: \$4.57/A Planter Program: \$67.66/A. Foliar Program: \$54.23/A. Fert Reallocation: \$40/A.

## Corteva™ Biologicals High Management Irrigated Soybean Study

**Objective:** To evaluate the yield and economic impact of a soybean liquid starter fertilizer and foliar nutritional program from Corteva in a high management irrigated environment. This trial consisted of the following:

### Treatments and Placement:

<b>#1. Control:</b>	150# 18-46-0, 150# 0-0-60, R3 Miravis®Neo
---------------------	---

### #2 At-Plant Fertility:

FurrowJet® Center: (Figure 1.)	4oz/A. BioForge Advanced™, 3 Gal/A. water carrier
--------------------------------	---

Conceal® Dual Band: (Figure 2.)	32oz/A. Harvest Plus™, 8 Gal/A. water carrier
---------------------------------	---

### #3 Foliar Applications:



V3: 8oz Xcyte™, 8oz Bio-Forge® Advanced, 32oz Harvest Plus®, 2oz/A. Utrisha® N

R3: 8oz Xcyte™, 2.5#/A. Harvest More® UreaMate, 1 Qt/A. Sugar Mover®, 8oz/A. Xcyte™

Figure 1. FurrowJet® Placement

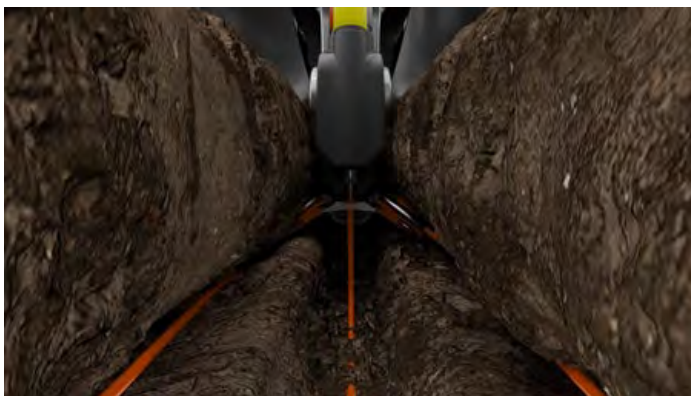

Figure 2. Conceal® Dual Band Placement



## Corteva™ Biologicals High Management Irrigated Soybean Study

All treatments received 5.00" of rain throughout the growing season as well as fungicide applications of 13.7oz/A. Miravis® Neo at R3 growth stage.

**Results:** At-Plant treatments resulted in yields of 102.6 Bu/A., +5.5 Bu/A. over the control. At-plant + foliar combination treatments pushed yield to 109.0 Bu/A., +11.9 Bu/A. over the control.

After all costs, at-plant nutritional treatments proved economic gains of +\$79.44/A., while the foliar/at-plant combination treatments tallied returns of +\$81.94/A.

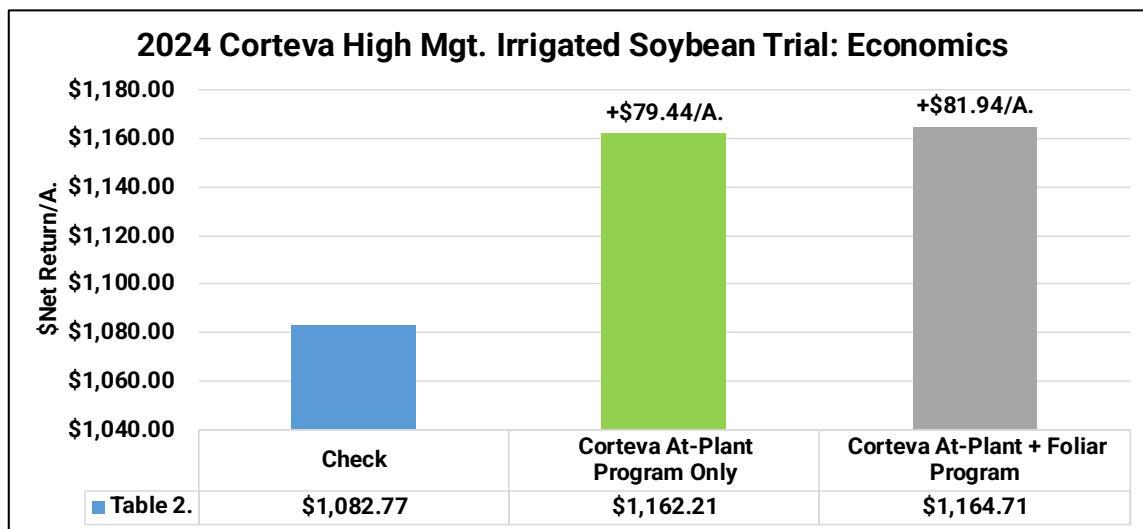
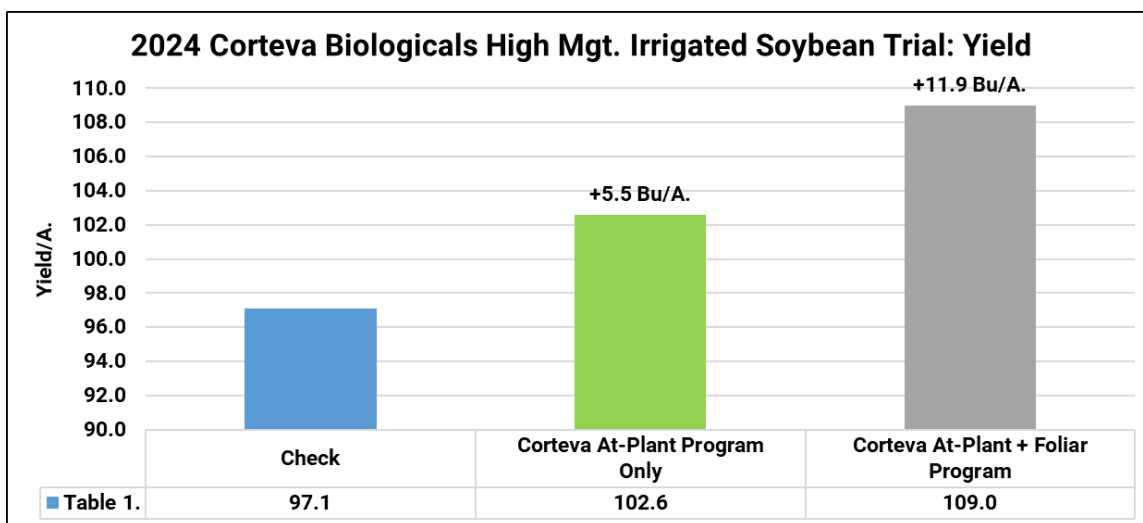

Planting Date: May 5<sup>th</sup> Variety: Pioneer 37Z06E Population: 120K Row Width: 30" Rotation: BAC SB Price: \$11.46

FurrowJet® Wings: \$7.50/A. Conceal® Program: \$6.09/A. Foliar Program: \$70.84/A. \$30 Fert. Reallocation

## Corteva™ Biologicals High Management Dryland Soybean Study

**Objective:** To evaluate the yield and economic impact of a soybean liquid starter fertilizer and foliar nutritional program from Corteva in a high management environment. This trial consisted of the following:

### Treatments and Placement:

<b>#1. Control:</b>	150# 18-46-0, 150# 0-0-60, R3 Miravis®Neo
---------------------	---

### #2 At-Plant Fertility:

FurrowJet® Center: (Figure 1.)	4oz/A. BioForge Advanced™, 3 Gal/A. water carrier
--------------------------------	---

Conceal® Dual Band: (Figure 2.)	32oz/A. Harvest Plus™, 8 Gal/A. water carrier
---------------------------------	---

### #3 Foliar Applications:



V3: 8oz Xcyte™, 8oz Bio-Forge® Advanced, 32oz Harvest Plus®, 2oz/A. Utrisha® N

R3: 8oz Xcyte™, 2.5#/A. Harvest More® UreaMate, 1 Qt/A. Sugar Mover®, 8oz/A. Xcyte™

Figure 1. FurrowJet® Placement

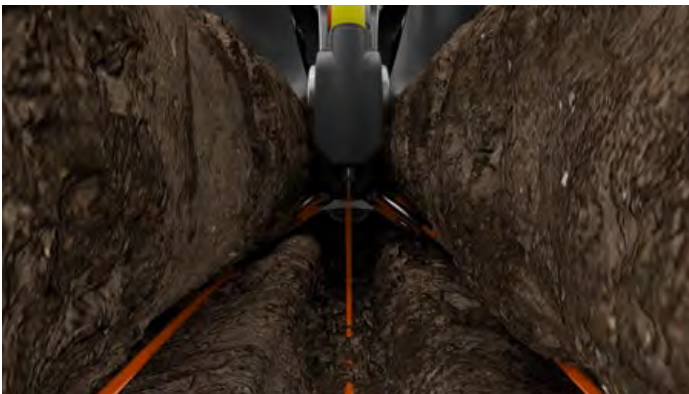

Figure 2. Conceal® Dual Band Placement



## Corteva™ Biologicals High Management Dryland Soybean Study

**Results:** At-Plant treatments resulted in yields of 74.2 Bu/A., +2.3 Bu/A. over the control. At-plant + foliar combination treatments pushed yield to 78.9 Bu/A., +7.0 Bu/A. over the control.

After all costs, at-plant nutritional treatments proved economic gains of +\$42.77/A., while the foliar/at-plant combination treatments tallied returns of +\$25.79/A.

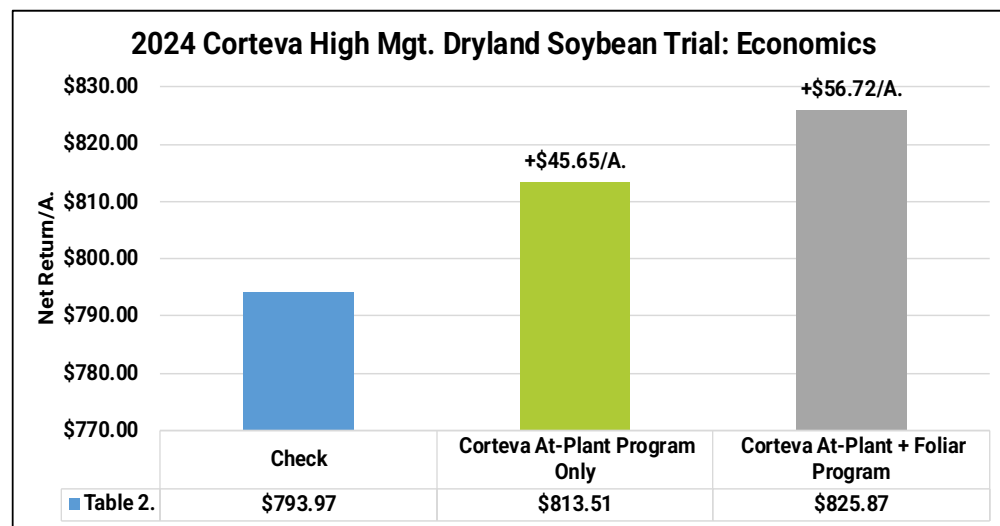
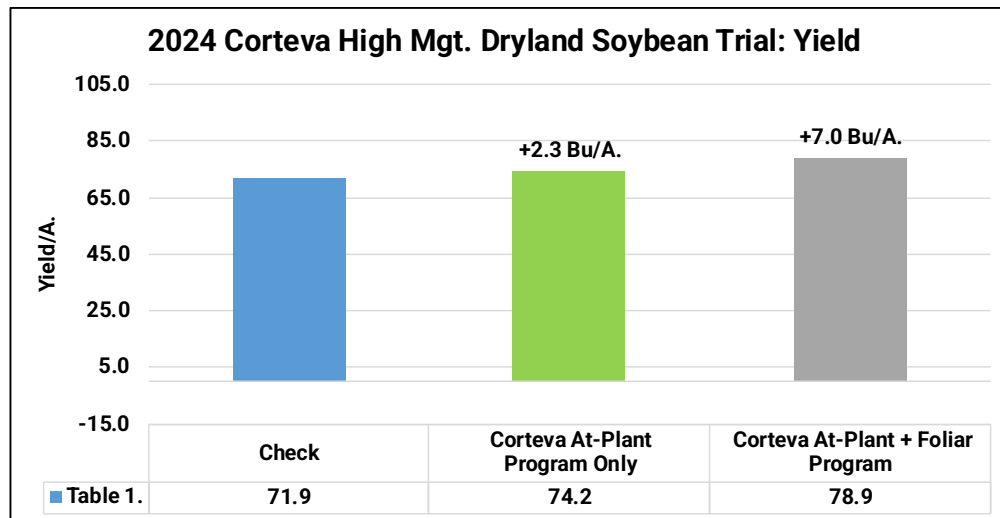

Planting Date: May 5<sup>th</sup> Variety: Pioneer 37Z06E Population: 120K Row Width: 30" Rotation: BAC SB Price: \$11.46

FurrowJet® Wings: \$7.50/A. Conceal® Program: \$6.09/A. Foliar Program: \$70.84/A. Fertilizer Re-Allocation: \$30/A.



## NewFields Ag™/NMS High Management Irrigated Soybean Study

**Objective:** To evaluate the yield and economic impact of a soybean liquid starter fertilizer and foliar nutritional program from NewFields Ag and Nutrient Management Specialists (NMS) in a high management irrigated environment. This trial consisted of the following:

### Treatments and Placement:

<b>#1. Control:</b>	150# DAP, 150# 0-0-60, R3 Miravis®Neo
<b>#2 At-Plant Fertility:</b>	1 oz MycoGold W Dust, 1 oz Envirozyme Hopper Box Trt.
FurrowJet® Center: (Figure 1.)	48oz High Energy Fish, 48oz Sea Crop, 1oz Kelp, 1oz Fulvic 16oz Agrovive SoyXF, 16oz Phenom®
FurrowJet® Wings: (Figure 1.)	1oz Seeder Heater, 16oz 5 way Sweetener, 1oz Yucca, .5oz Moly, 4oz ZnSO4 32%, 4 oz MnSO4 32%, 16oz Growthful, 32oz 9-45-15W
Conceal® Dual Band: (Figure 2.)	80oz 9-45-16 w/micros, 16oz Humic 24%



Figure 1. FurrowJet® Placement



Figure 2. Conceal® Dual Band Placement



## NewFields Ag™/NMS High Management Irrigated Soybean Study

All treatments received 5.00" of rain throughout the growing season as well as fungicide applications of 13.7oz/A. Miravis® Neo at R1 and 13.7oz/A. of TrivaPro® at R3 growth stages.

### #3 Foliar Applications:

V3: 16oz Frenzy, 16oz Phenom®, 2oz Carry-R MA

R1: 16oz Frenzy

R2: 16oz 9-45-45 +Micros, 1 oz Kelp, 1oz Yucca,  
24oz High Energy Fish, 24oz Sea Crop, 2oz Molly, 4oz  
ZnSO4 32%, 4oz MnSO4 32%, 1oz Fulvic, 12.8oz 5 Way  
Sweetener, 5oz Aloe, .5oz Seeder Heater, 32oz  
Potassium Acetate

**Results:** At-Plant treatments resulted in yields of 90.1 Bu/A., +2.3 Bu/A. over the control. At-plant + foliar combination treatments pushed yield to 96.7 Bu/A., +8.9 Bu/A. over the control.

After all costs and application, at-plant nutritional treatments proved economic gains of +\$13.57/A., while the foliar/at-plant combination treatments tallied returns of +\$20.06/A.

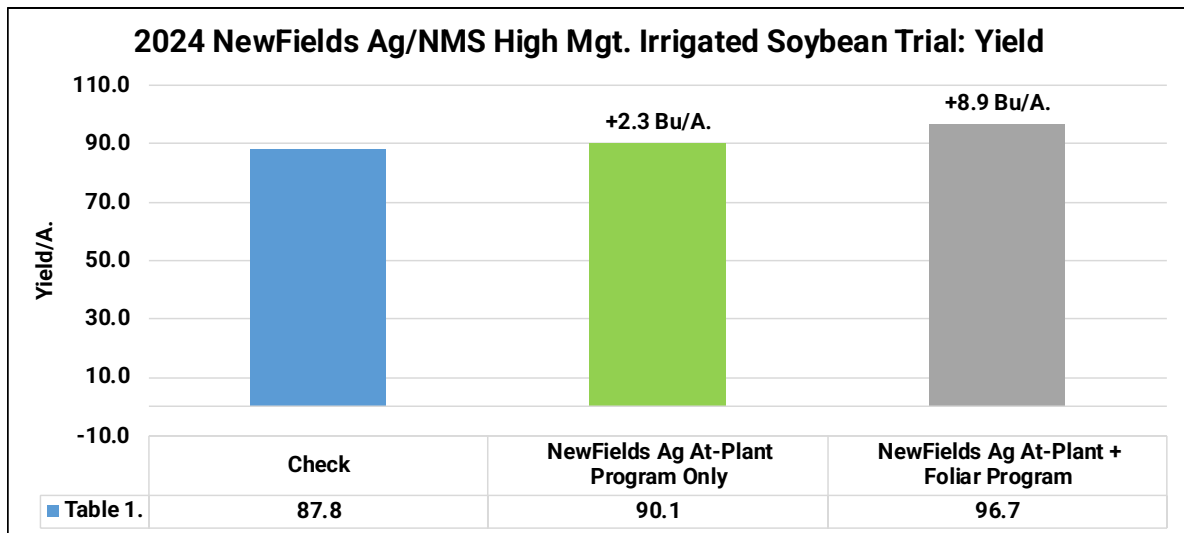

Planting Date: April 20<sup>th</sup> Variety: GH 3035E3 Population: 120K Row Width: 30" Rotation: BAC SB Price: \$11.46

At-Plant Program: \$42.79/A. Foliar Program: \$69.14/A. Fertilizer Re-Allocation: \$30/A.

## NewFields Ag™/NMS High Management Dryland Soybean Study

**Objective:** To evaluate the yield and economic impact of a soybean liquid starter fertilizer and foliar nutritional program from NewFields Ag and Nutrient Management Specialists (NMS) in a high management non-irrigated environment. This trial consisted of the following:

### Treatments and Placement:

<b>#1. Control:</b>	150# DAP, 150# 0-0-60, R3 Miravis®Neo
<b>#2 At-Plant Fertility:</b>	1 oz MycoGold W Dust, 1 oz Envirozyme Hopper Box Trt.
FurrowJet® Center: (Figure 1.)	48oz High Energy Fish, 48oz Sea Crop, 1oz Kelp, 1oz Fulvic 16oz Agrovive SoyXF, 16oz Phenom®
FurrowJet® Wings: (Figure 1.)	1oz Seeder Heater, 16oz 5 way Sweetener, 1oz Yucca, .5oz Moly, 4oz ZnSO4 32%, 4 oz MnSO4 32%, 16oz Growthful, 32oz 9-45-15W
Conceal® Dual Band: (Figure 2.)	80oz 9-45-16 w/micros, 16oz Humic 24%



Figure 1. FurrowJet® Placement

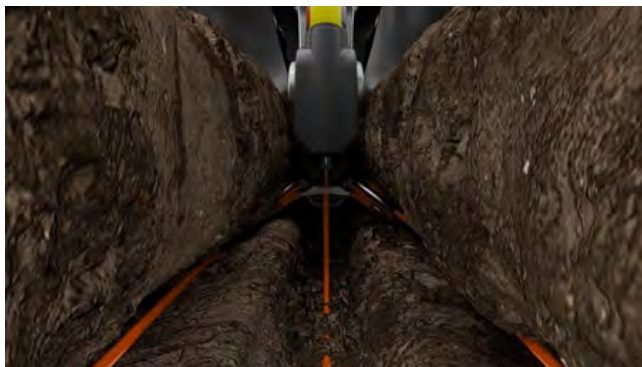

Figure 2. Conceal® Dual Band Placement



## NewFields Ag™/NMS High Management Dryland Soybean Study

All treatments received 5.00" of rain throughout the growing season as well as fungicide applications of 13.7oz/A. Miravis® Neo at R1 and 13.7oz/A. of TrivaPro® at R3 growth stages.

### #3 Foliar Applications:

V3: 16oz Frenzy, 16oz Phenom®, 2oz Carry-R MA

R1: 16oz Frenzy

R2: 16oz 9-45-45 +Micros, 1 oz Kelp, 1oz Yucca,  
24oz High Energy Fish, 24oz Sea Crop, 2oz Molly, 4oz  
ZnSO4 32%, 4oz MnSO4 32%, 1oz Fulvic, 12.8oz 5 Way  
Sweetener, 5oz Aloe, .5oz Seeder Heater, 32oz  
Potassium Acetate

**Results:** At-Plant treatments resulted in yields of 72.1 Bu/A., +3.0 Bu/A. over the control. At-plant + foliar combination treatments pushed yield to 77.5 Bu/A., +8.4 Bu/A. over the control.

After all costs and application, at-plant nutritional treatments proved economic gains of +\$21.59/A., while the foliar/at-plant combination treatments tallied returns of +\$14.33/A.

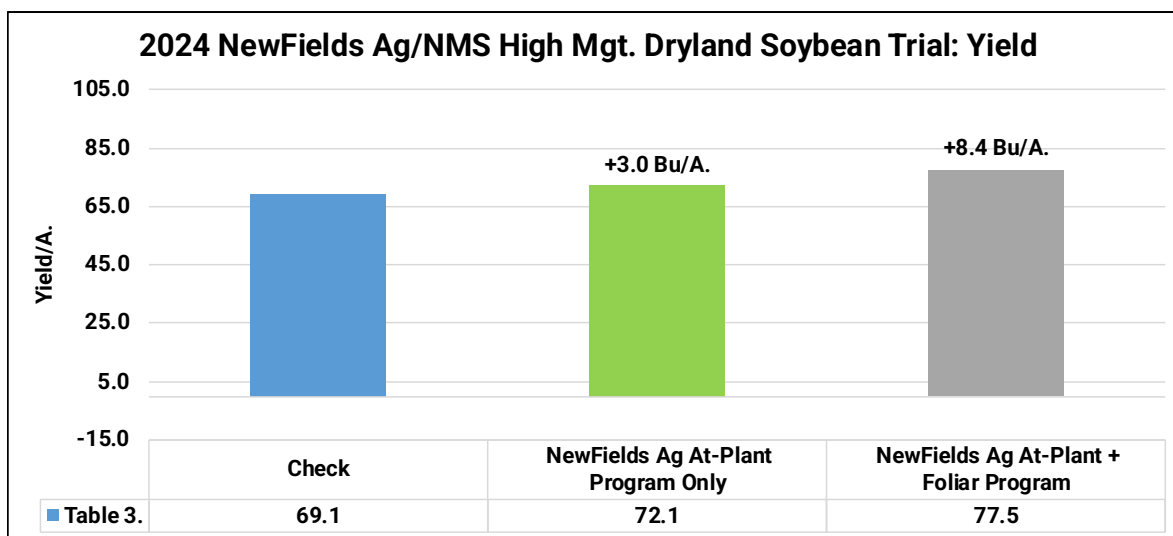

Planting Date: April 20<sup>th</sup> Variety: GH 3035E3 Population: 120K Row Width: 30" Rotation: BAC SB Price: \$11.46

At-Plant Program: \$42.79/A. Foliar Program: \$69.14/A. Fertilizer Re-Allocation: \$30/A.

## Marco Fertilizer NutriStart BOOST 14-12-4-6S Study

**Objective:** This trial evaluates the yield and net return of Conceal® system dual band treatments of NutriStart BOOST 14-12-12-4-6S at 15 Gal/A. rate. This liquid fertilizer is a 70% polyphosphate, and 30% orthophosphate formula designed for non-in furrow applications in soybeans. NutriStart products are manufactured with Marco 10-34-0, Potassium - soluble potash (K<sub>2</sub>O), Sulfur - Ammonium Thiosulfate and Zinc - 9% EDTA.



Figure 1. Conceal® Dual Placement

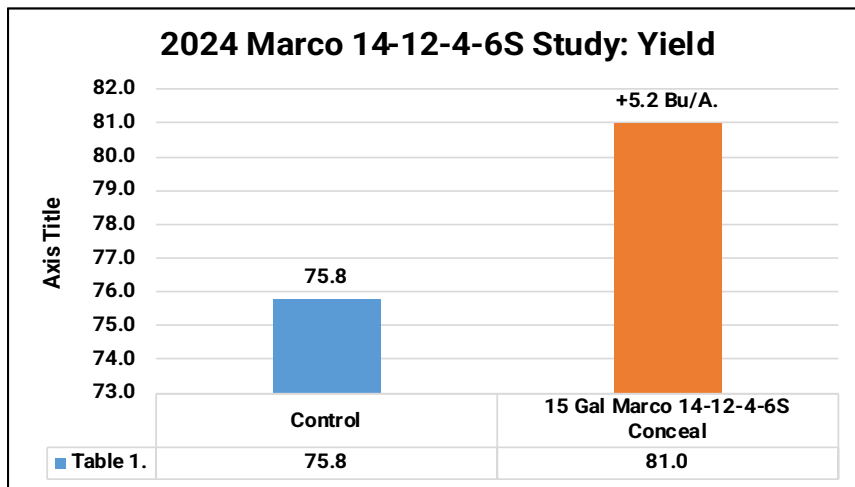

**Results:** Table 1. illustrates that 14-12-4-6S proved positive yield gains of 5.2 Bu/A. at 15 Gal resulting in an economic gain of +\$31.84/A. Multi-year data shows 15 Gal/A. proving the highest economic return at +\$44.74/A.

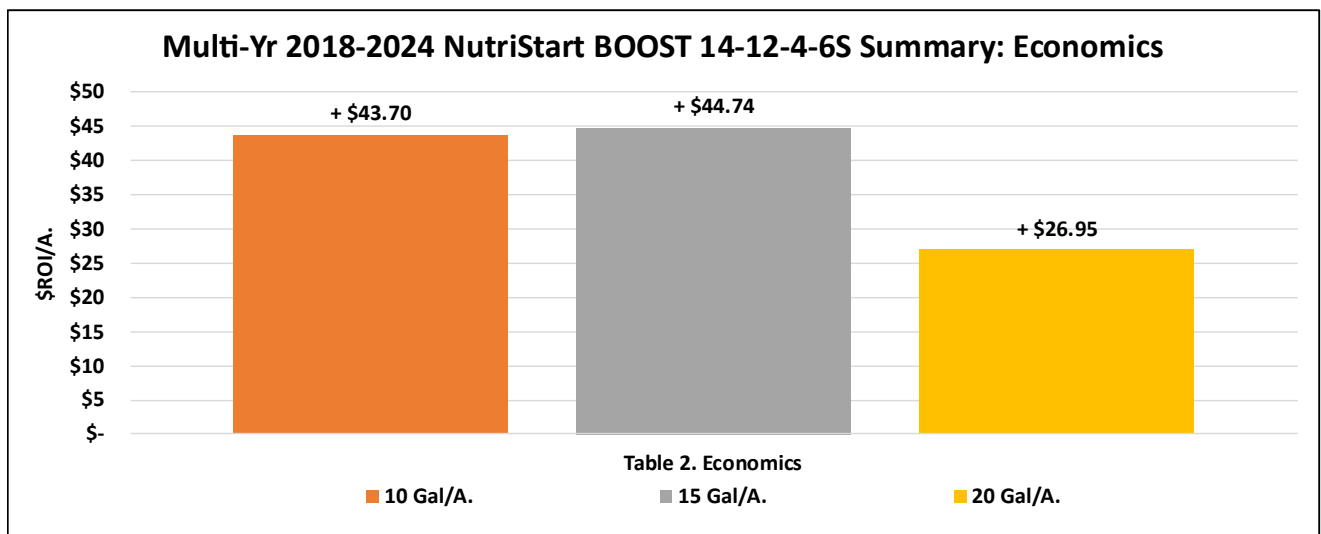

Planting Date: April 24<sup>th</sup>

Variety: AG 35XF3

Population: 120K

Row Width: 30"

Rotation: BAC

SB Price: \$11.46

BOOST 14-12-4-6: \$3.85/Gal

## Marco Fertilizer NutriStart BOOST 14-12-4-6S + NanoN+® Study

**Objective:** This trial evaluates the yield and net return of Conceal® system dual band treatments of NutriStart BOOST 14-12-12-4-6S at 15 Gal/A. rate. This liquid fertilizer is a 70% polyphosphate, and 30% orthophosphate formula designed for non-in furrow applications in soybeans. NutriStart products are manufactured with Marco 10-34-0, Potassium - soluble potash (K2O), Sulfur - Ammonium Thiosulfate and Zinc - 9% EDTA.



NanoN+® is designed to protect and carry nutrients in liquid solutions to improve efficiency and reduce waste. NanoN+® enhances plant nutrient uptake and availability for liquid nutrient formulations including macronutrient and micronutrient products.

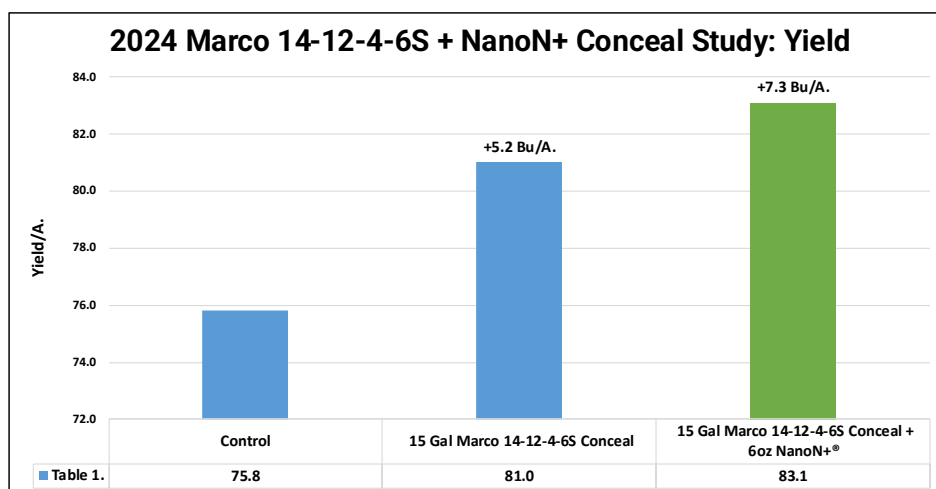

**Results:** Table 1. illustrates that 14-12-4-6S proved positive yield gains of 5.2 Bu/A. at 15 Gal resulting in an economic gain of +\$31.84/A. Adding 6oz of NanoN+ with 14-12-4-6S resulted in a positive yield gain of +7.3 Bu/A. over the control, providing a positive return on investment of +\$45.75/A.

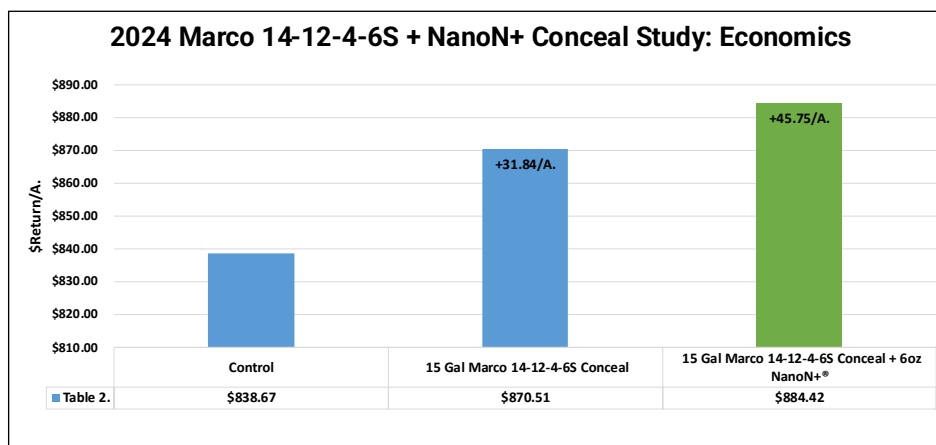

Figure 1. Conceal® Dual Placement



Planting Date: April 24th    Variety: AG 35XF3    Population: 120K    Row Width: 30"    Rotation: BAC    SB Price: \$11.46    BOOST 14-12-4-6: \$3.85/G    Aqua-Yield NanoN+®: \$7.34/A.

## Aqua-Yield® NanoCS™ FurrowJet® Study

**Objective:** To evaluate yield and economics of NanoCS® by AQUA-YIELD. NanoCS™ is a starter fertilizer enhancer with a robust combination of NanoShield® Technology, balanced NPK, Zinc, and Bio Stimulant. Aqua-Yield products contain nanoparticles that penetrate cell walls and create a nano-sized shield around nutrient/molecules/ions. This technology delivers essential nutrients into the seed for rapid germination and growth.

This trial aims to establish the efficiency of Aqua-Yield’s NanoCS™ nano-liquid based fertility product in tandem with QLF 5-5-5S in-furrow starter fertilizer. The performance of a 50% rate reduction (1.5Gal/A.) of LTE is then compared to the 100% rate (3 Gal/A). NanoCS™ was applied in-furrow at planting in a FurrowJet® center only application (Figure 1).



Figure 1: FurrowJet® In-Furrow Application

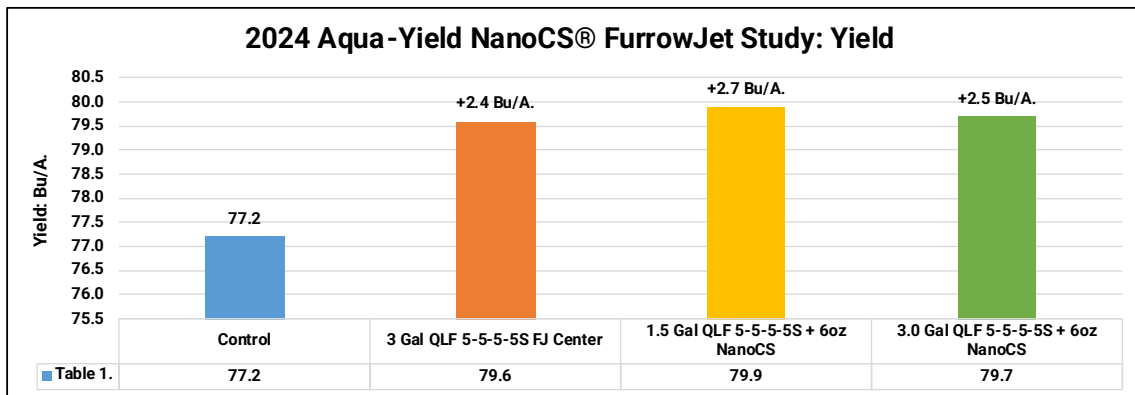

AQUA-YIELD®

**NanoCS™**

## Aqua-Yield® NanoCS™ FurrowJet® Study Continued

**Results:** Table 1. illustrates yield results of all treatments. The control treatment brought yields of 77.2Bu/A. The 100% rate treatment at 3 Gal/A. of QLF resulted in yields of +2.4 Bu/A.

Aqua-Yield's 6oz NanoCS® tank-mixed with 50% (1.5 Gal) QLF rates resulted in +2.7 Bu/A. yield improvement over the control treatment. Finally, 6oz NanoCS® + 3 Gal/A. of QLF resulted in yield gains of +2.5 Bu/A.



Table 2. illustrates the overall economics of the fertility study. Full 3 gal/A. rates of 5-5-5S resulted in economic gains of +\$45.20/A. Keeping that full 3 gal/A. rate and tank mixing NanoCS™ resulted in gains of +\$37.68/A. Reducing QLF in-furrow applications by 50% and tank-mixing NanoCS™ resulted in economic gains of +\$46.12/A., +\$0.92/A. better than the 100% rate.

As farmers, we are always interested in the ability to reduce fertilizer rates without sacrificing yield or profitability and we look forward to testing this product another year in 2025.

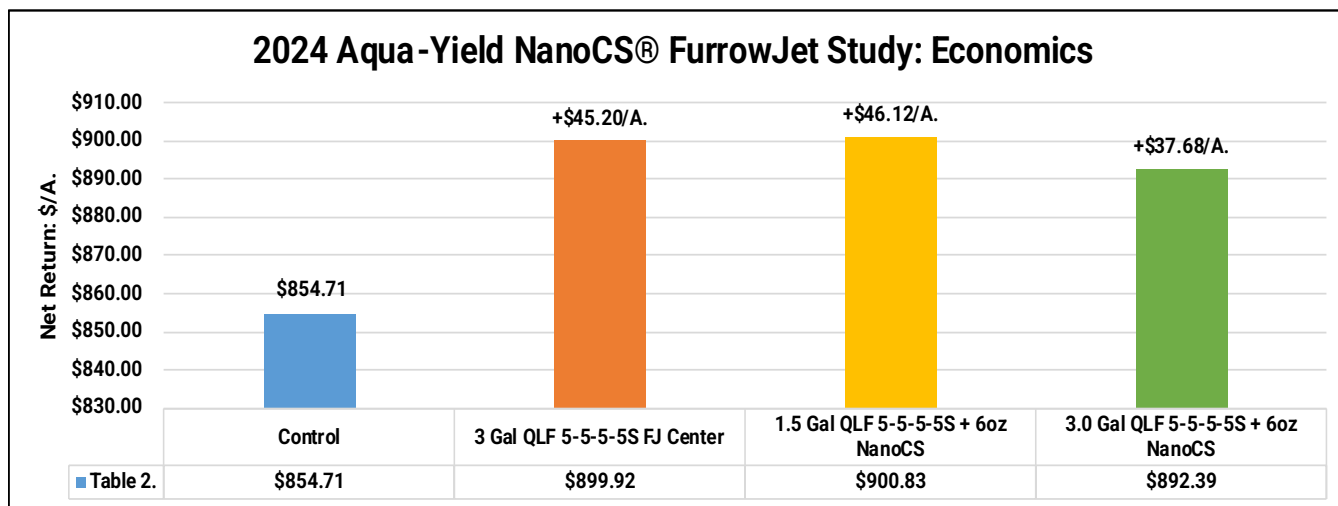

Planting Date: May 22<sup>nd</sup> Variety: GH 3994E3 Population: 36K Row Width: 30" Rotation: CAB SB Price: \$11.46

NanoCS: \$8.67/A. QLF 5-5-5S: \$4.10/Gal 30\$ Fert. Reallocation



## Irrigated vs Dryland FurrowJet®/Conceal® ROI Analysis

**Objective:** To evaluate the difference in return on investment of at-plant FurrowJet® and Conceal® (Figures 1-2.) nutritional programs in both irrigated and dryland environments.

It is a common question at the PTI Farm for growers to ask if the yield and economic response of at-plant treatments of FurrowJet® and Conceal® is similar in both irrigated, as well as dryland environments? This study evaluates the 2024 high yield corn management trials and isolates the difference in return on investment (ROI) of irrigated versus dryland programs.

**Results:** Irrigated environments offered average return on investment of +4.05% in At-Plant and Combination programs. Both environments performed similarly, however irrigated treatments offered greater than the dryland treatments.

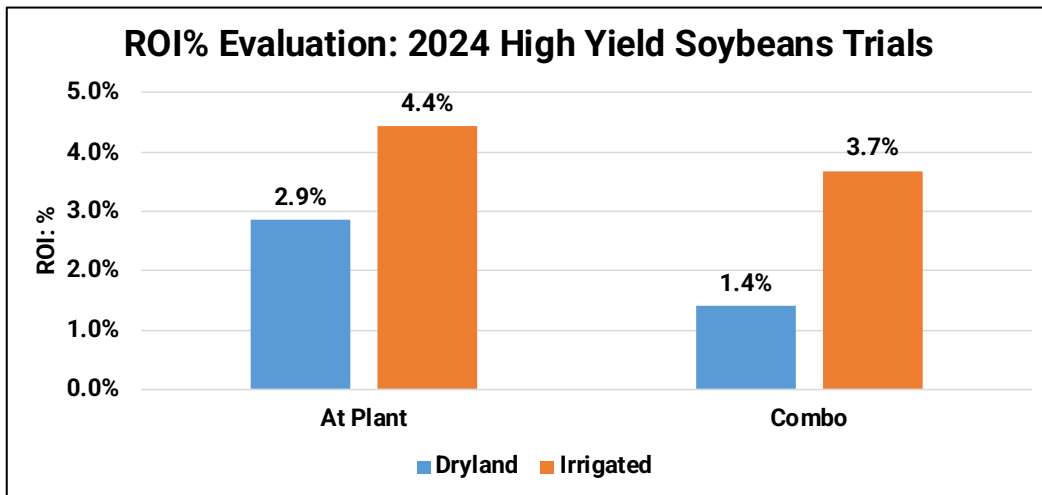

Figure 2. FurrowJet® Placement

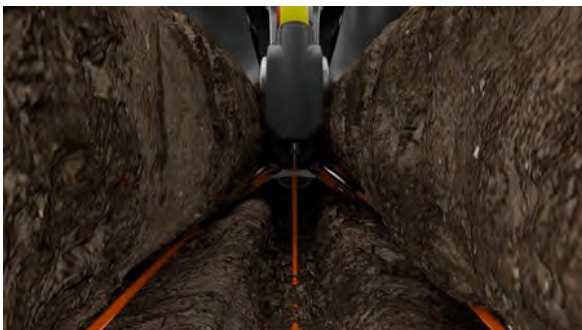

Figure 1. Conceal® Placement



**PhycoTerra® Conceal®**

## FurrowJet® Soil Amendment Study

**Objective:** To evaluate yield and economics of PhycoTerra®, a liquid microbial food product that delivers a superior, balanced meal to the starving, dormant microbes in soil. PhycoTerra® activates the soil microbiome (up to 33x) by delivering a superior balanced meal to dormant, native microbes. Waking up microbes, both bacteria and fungi, early in the season can help support your crop throughout the growing season. PhycoTerra® delivers a unique mode-of-action to improve soil structure, increase water holding capacity, and optimize nutrient (NPK) availability. Improved soil quality and health supports crops through abiotic stress throughout each crop season. PhycoTerra® was applied at planting in a dual band Conceal® and FurrowJet® in-furrow application (Figures 1-2).



Product Type	g Food/L	g Protein per L	g Lipids per L	g Carb per L	g Ash per L
Molasses Product	74	4	0.8	60	10
Humic Acid Product	7	1	0.12	2	4
Seaweed Product	32	1	0.5	15	15
PhycoTerra®	92	24	21	44	3

Figure 1. Conceal Placement

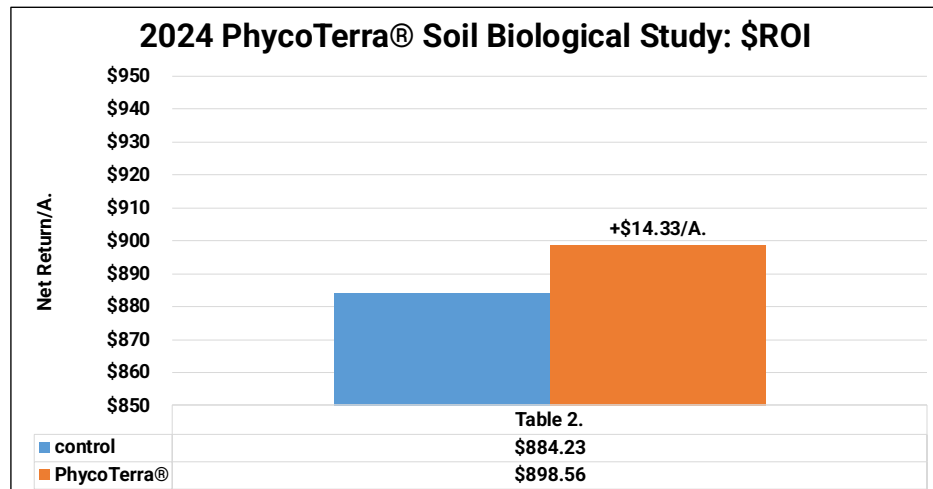
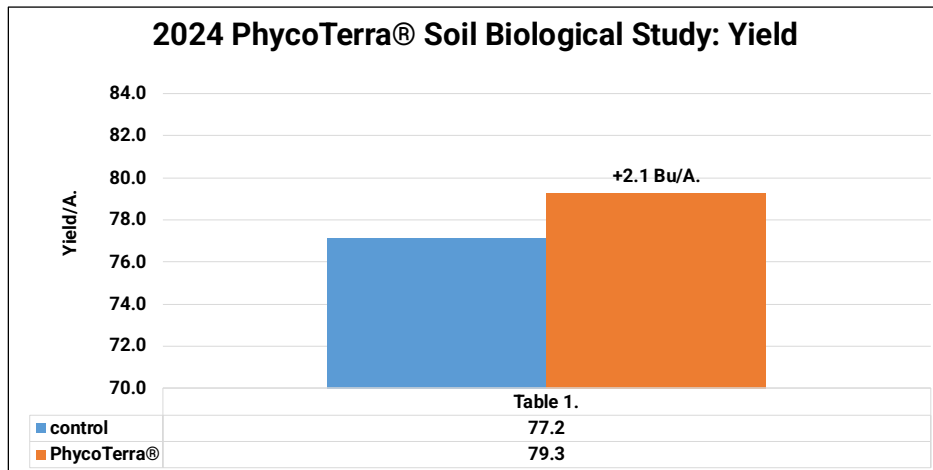

Figure 2. FurrowJet® Placement



## PhycoTerra® Conceal® FurrowJet® Soil Amendment Study

**Results:** Table 1. illustrates at-plant treatments of PhycoTerra® resulted in yield gains of +2.1 Bu/A. At a product cost of \$10/A., these yield gains corresponded to positive net returns of +\$14.33/A.



Planting Date: May 10<sup>th</sup> Variety: GH 3994E3 Population: 130K Row Width: 30" Rotation: SAC SB Price: \$11.46 PhycoTerra®: \$10/A.

## FurrowJet® Side-Wall Study

**Objective:** FurrowJet® system is a planter fertilizer attachment (Figure 1.) that enables placement of not only an in-furrow starter fertilizer, but also a dual-band of fertilizer 3/4" on each side of the seed. To achieve this dual-band placement, the wings on FurrowJet® system angle downward to cut into the sidewall and place fertilizer alongside the seed in a dual-band. By doing this, lifting and fracturing can occur that potentially could remove soil smearing or compaction created by disc openers. Additionally, closing wheel systems following FurrowJet® wings have a better opportunity to close the seed trench, remove air pockets, and allow for good seed-to-soil contact.

Figure 1. FurrowJet®

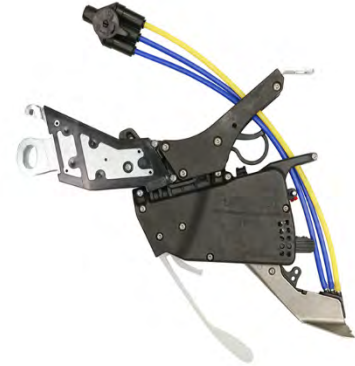

This study evaluates FurrowJet® dual-band wings offering the ability to cut, lift and remove side-wall compaction in the seed furrow (Figure 2). For this study, no liquid fertilizer was applied.

Figure 2: FurrowJet® Dual-Band Wings Fracturing Side-Walls



**Results:** In 2024, FurrowJet® alleviating sidewall density resulted in +2.0 Bu/A. average yield gains. Table 1. below illustrates multi-year data over 2020-2024 with average yield gain of +1.5 Bu/A. Using a soybean commodity price of \$11.46 and a cost of \$320/Row for FurrowJet® systems, break-even would occur on a 16-row planter with this scenario at 298 acres, not even considering any liquid fertilizer potential benefit.

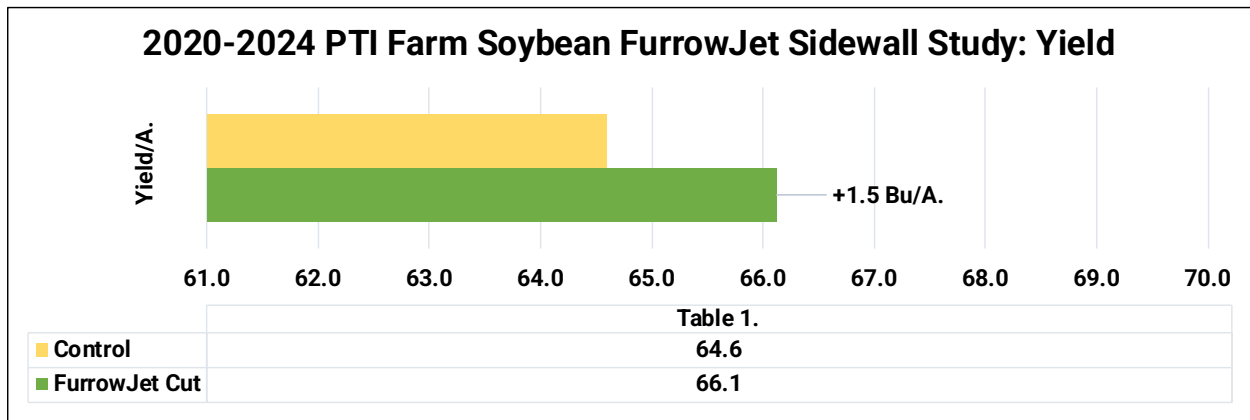

## Soybean Summary of 2024 FurrowJet® Applications

Study	Classification	Yield (Bu/A.)	\$ROI
Corteva Irrigated High Management Soybean At- Plant	Starter Fertilizer/ Nitrogen	5.5 \$	79.44
April 16th Soybean Planting Date with Starter	Starter Fertilizer	6.4 \$	56.18
Marco Irrigated High Management Soybean At- Plant	Starter Fertilizer/ Nitrogen	5.2 \$	52.77
May 11th Soybean Planting Date with Starter	Starter Fertilizer	5.7 \$	48.16
Aqua-Yield NanoCS 6oz + QLF 5-5-5-5s 1.5 Gal	Starter Fertilizer	2.7 \$	46.12
Nachurs Irrigated High Management Soybean At- Plant	Starter Fertilizer/ Nitrogen	4.9 \$	45.52
QLF 5-5-5-5s 3 Gal	Starter Fertilizer	2.4 \$	45.20
Corteva Dryland High Management Soybean At- Plant	Starter Fertilizer/ Nitrogen	2.3 \$	42.77
Match 13th Soybean Planting Date with Starter	Starter Fertilizer	4.8 \$	37.85
Aqua-Yield NanoCS 6oz + QLF 5-5-5-5s 3 Gal	Starter Fertilizer	2.5 \$	37.68
AgroLiquid Irrigated High Management Soybean At- Plant	Starter Fertilizer/ Nitrogen	6.6 \$	34.46
Marco Dryland High Management Soybean At- Plant	Starter Fertilizer/ Nitrogen	3.4 \$	32.14
May 22nd Soybean Planting Date with Starter	Starter Fertilizer	3.8 \$	26.39
FurrowJet Side-Wall Cut	Mechanical	2 \$	22.92
NewFields Ag/ NMS Dryland High Management Soybean At- Plant	Starter Fertilizer/ Nitrogen	3 \$	21.59
Nachurs Dryland High Management Soybean At- Plant	Starter Fertilizer/ Nitrogen	2.8 \$	21.45
QLF Irrigated High Management Soybean At- Plant	Starter Fertilizer/ Nitrogen	4.4 \$	18.19
NewFields Ag/ NMS Irrigated High Management Soybean At- Plant	Starter Fertilizer/ Nitrogen	2.3 \$	13.57
AgroLiquid Dryland High Management Soybean At- Plant	Starter Fertilizer/ Nitrogen	4.5 \$	10.39
QLF Dryland High Management Soybean At- Plant	Starter Fertilizer/ Nitrogen	3.1 \$	3.29
June 3rd Soybean Planting Date with Starter	Starter Fertilizer	1.6 \$	1.17
Average		3.8 \$	33.20

## Soybean Summary of 2024 Conceal® Applications

Study	Classification	Yield (Bu/A.)	\$ROI
Corteva Irrigated High Management Soybean At- Plant	Starter Fertilizer/Nitrogen	5.5 \$	79.44
April 16th Soybean Planting Date with Starter	Starter Fertilizer	6.4 \$	56.18
Marco Irrigated High Management Soybean At- Plant	Starter Fertilizer/Nitrogen	5.2 \$	52.77
May 11th Soybean Planting Date with Starter	Starter Fertilizer	5.7 \$	48.16
Marco 14-12-4-6S: 15 Gal + NanoN+ 6oz	Starter Fertilizer	7.3 \$	45.75
Nachurs Irrigated High Management Soybean At- Plant	Starter Fertilizer/Nitrogen	4.9 \$	45.52
Corteva Dryland High Management Soybean At- Plant	Starter Fertilizer/Nitrogen	2.3 \$	42.77
Match 13th Soybean Planting Date with Starter	Starter Fertilizer	4.8 \$	37.85
AgroLiquid Irrigated High Management Soybean At- Plant	Starter Fertilizer/Nitrogen	6.6 \$	34.46
Marco Dryland High Management Soybean At- Plant	Starter Fertilizer/Nitrogen	3.4 \$	32.14
Marco 14-12-4-6S: 15 Gal	Starter Fertilizer	5.2 \$	31.84
May 22nd Soybean Planting Date with Starter	Starter Fertilizer	3.8 \$	26.39
NewFields Ag/ NMS Dryland High Management Soybean At- Plant	Starter Fertilizer/Nitrogen	3 \$	21.59
Nachurs Dryland High Management Soybean At- Plant	Starter Fertilizer/Nitrogen	2.8 \$	21.45
QLF Irrigated High Management Soybean At- Plant	Starter Fertilizer/Nitrogen	4.4 \$	18.19
NewFields Ag/ NMS Irrigated High Management Soybean At- Plant	Starter Fertilizer/Nitrogen	2.3 \$	13.57
AgroLiquid Dryland High Management Soybean At- Plant	Starter Fertilizer/Nitrogen	4.5 \$	10.39
QLF Dryland High Management Soybean At- Plant	Starter Fertilizer/Nitrogen	3.1 \$	3.29
June 3rd Soybean Planting Date with Starter	Starter Fertilizer	1.6 \$	1.17
Average		4.4 \$	32.79

## Summers® Soybean Rolling Study

**Objective:** To study the yield and economic impact of rolling soybeans with a Summers® RH3330 50' land roller .

The benefits of using a roller in soybeans include the following:

- Pushing or pressing rocks into soil to avoid harvest issues
- Lays corn residue flat to aid in cleaner seed at harvest
- Stimulate reproductive growth after rolling damage occurs



**Results:** Table 1. illustrates multi-year soybeans rolled at the V3 growth stage resulted in yield gains of +3.6 Bu/A. in 2022, +2.4 Bu/A. in 2023 and +2.9 Bu/A. in 2024. These yield advantages equated to a positive return on investment of +\$42.26/A. in 2022, +\$23.42 in 2023 and +\$25.23 in 2024.

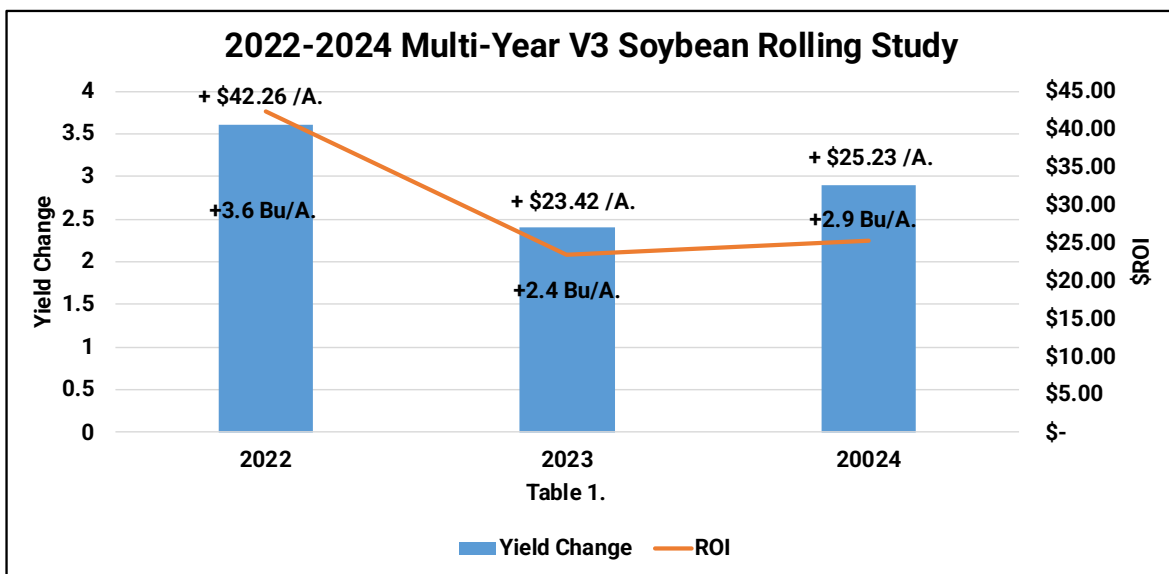

Planting Date: May 15<sup>th</sup>    Variety: Becks 3300E3    Population: 130K    Row Width: 15"    Rotation: BAC, No-Till    Soybean Price: \$11.46    Rolling: \$8/A.

## Soybean Row Width & Seeding Rate Study

**Objective:** This trial evaluates the agronomic and economic impact of planting two soybean varieties (Asgrow 27XF3 and Golden Harvest 3724XF) at seeding rates ranging from 50K to 175K in 15" and 30" row spacing.

### 30" Wide Row Results:

- ✓ 100K/A. achieved both agronomic and economic optimum seeding rate in 30" rows
- ✓ High yield was 73.6 Bu/A.
- ✓ Low seeding rates of 50K/A. resulted in yield losses of **-10.4 Bu/A.**, proving economic losses of **-\$129.55/A.**
- ✓ Over-seeding at 125-175K rates resulted in yield losses of **-1.6 Bu/A** to **-7.7 Bu/A.** with respective economic losses of **-\$34.49** to **-\$160.08/A.**

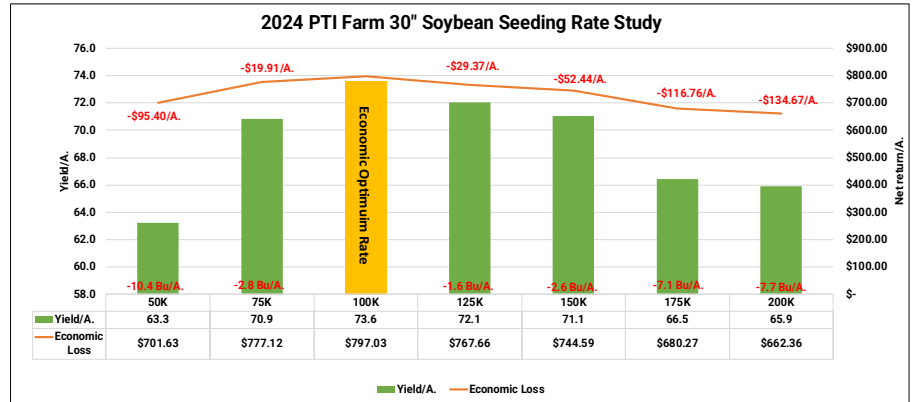

### 15" Narrow Row Results:

- ✓ 125K/A. achieved both agronomic and economic optimum seeding rate in 30" rows
- ✓ High yield was 75.6 Bu/A.
- ✓ Lower seeding rates of 75K/A. resulted in highest yield losses of **-15.1 Bu/A.**, proving economic losses of **-\$188.05/A.**
- ✓ Over-seeding at 150-200K rates resulted in yield losses of **-1.5 Bu/A** to **-3.3 Bu/A.** with respective economic losses of **-\$56.22** to **-\$65.28/A.**

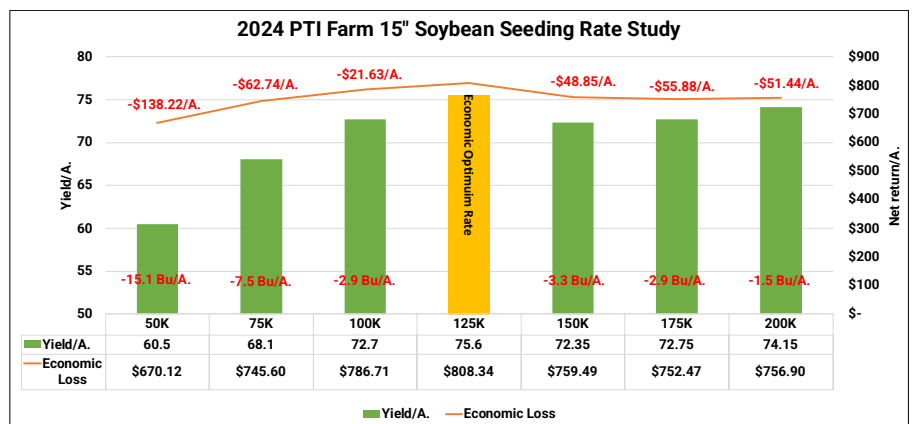

## Soybean Row Width & Seeding Rate Study Continued

### 15" vs 30" Row Width Summary:

- ✓ In popular or common seeding rates today of 100K to 150K, 15" rows out-performed wide 30" rows by only +1.9 Bu/A.
- ✓ +1.9 Bu/A. yield gains at \$11.46/Bu. soybeans proves additional revenue of +\$21.28/A.
- ✓ Multi-Year data at the PTI Farm has resulted in narrow row advantages of +3.0 Bu/A. with additional net revenue of +\$32.43/A. 30" rows have resulted in economic optimum seeding rates at 100K, while narrow rows at 125K.

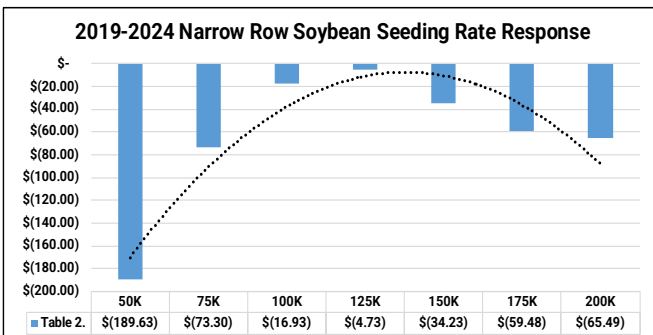
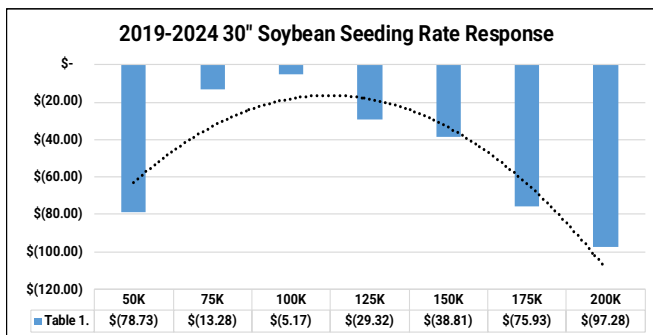
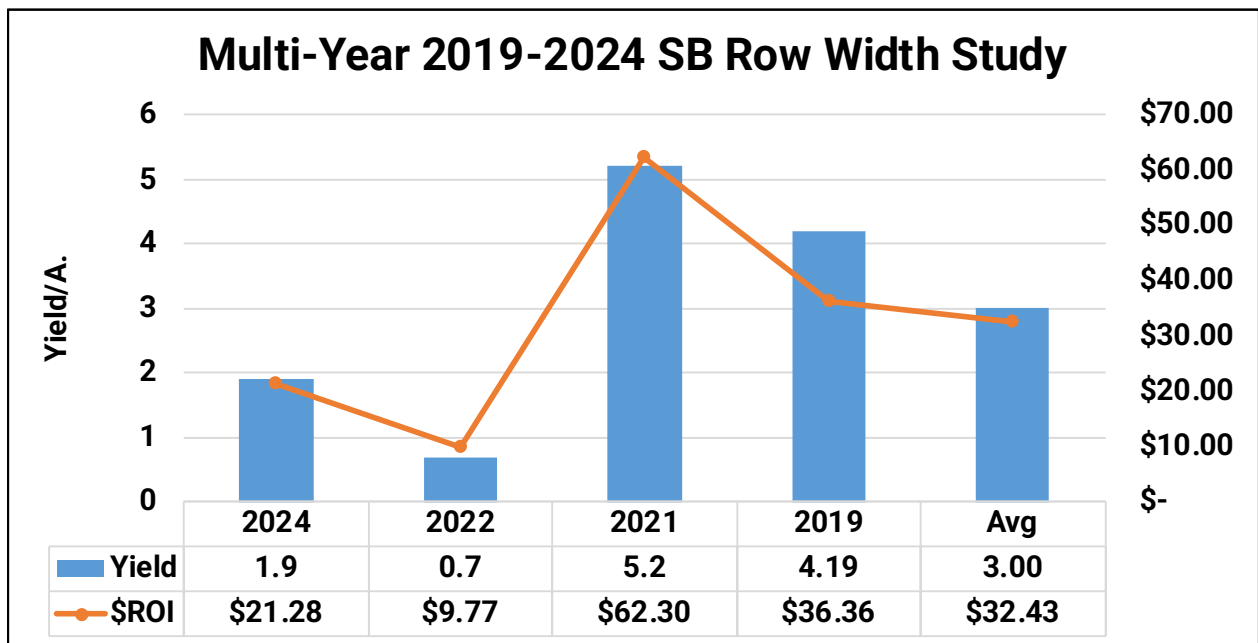

Planting Date: May 3<sup>rd</sup> Variety: Golden Harvest® 3724XF, Asgrow 27XF3 Population: Varied Row Width: 30" Rotation: BAC SB Price: \$11.46 Seed: \$60/Bag.



## Revytek™ Soybean Foliar Fungicide Study

**Objective:** To evaluate the yield and net return of a new triazole soybean fungicide introduced in 2020 called Revytek™. Revytek™ contains Revysol, which is a DeMethylation Inhibitor (DMI) fungicide that is part of the triazole group of fungicides. It was initially labeled for 17 crops, including corn and soybeans. Revytek™ gives excellent control of frogeye leaf spot, septoria, target spot, and Asian soybean rust.

**Results:** Tables 1 illustrates foliar applications of Revytek™ resulted in yield gains of +4.6 Bu/A. at R1 and +7.3 Bu/A. at R3 growth stage applications. Combo R1/R3 resulted in +9.4 Bu/A. yield response.

After cost of application and fungicide, Revytek™ proved positive net returns of +\$21.72, +\$52.66, and +\$45.72 respectively (Table 2).



Mefentrifluconazole	Group	3	Fungicide
Fluxapyroxad	Group	7	Fungicide
Pyraclostrobin	Group	11	Fungicide

# Revytek™

Fungicide



We create chemistry

**Active Ingredients\*:**

mefentrifluconazole: 2-[4-(4-chlorophenoxy)-2-(trifluoromethyl)phenyl]-1-(1H-1,2,4-triazole-1-yl)propan-2-ol	11.61%
pyraclostrobin: (carbamic acid, [2-[[[1-(4-chlorophenyl)-1H-pyrazol-3-yl]oxy]methyl]phenyl]methoxy-, methyl ester)	15.49%
fluxapyroxad: 1H-Pyrazole-4-carboxamide, 3-(difluoromethyl)-1-methyl-N-(3',4',5'-trifluoro[1,1'-biphenyl]-2-yl)-	7.74%
<b>Other Ingredients:</b>	65.16%
<b>Total:</b>	100.00%

\*Revytek™ fungicide contains 1.11 lbs mefentrifluconazole, 1.48 lbs pyraclostrobin, and 0.74 lb fluxapyroxad per gallon.

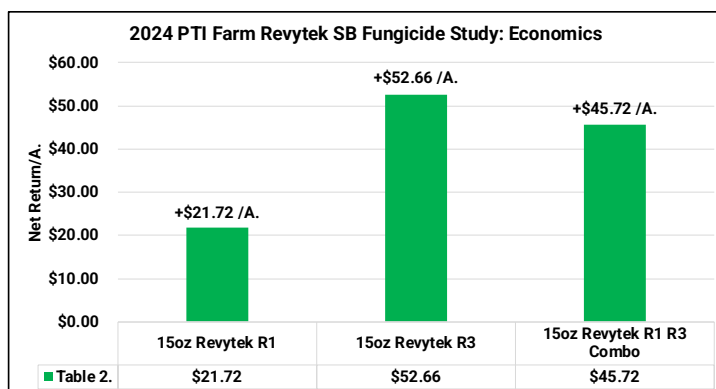
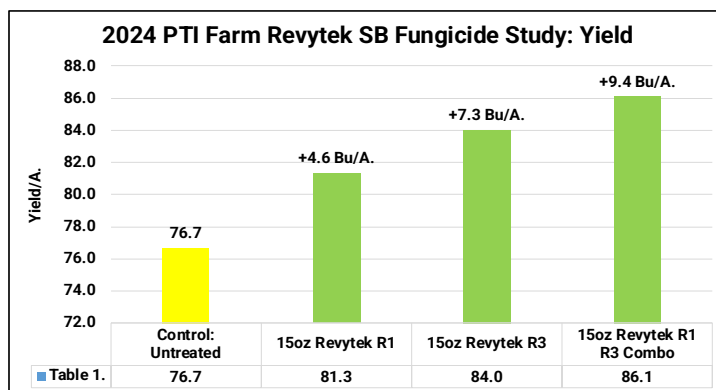

Planting Date: May 3<sup>rd</sup> Variety: Golden Harvest® 3724XF Population: 130K Row Width: 30" Rotation: BAC SB Price: \$11.46 Revytek + App: \$31/A.

## Soybean Foliar Fungicide/ Insecticide Study

**Objective:** To evaluate the yield and economics of an application of fungicide along with an application of fungicide paired with an insecticide. This study compares the use of 3 fungicides with and without an insecticide application, all applied with UAV (unmanned ag vehicle) at 3Gal/A.



ADEPIDYN® Technology\*

Active Ingredients:	
Pydiflumetofen**	7.0%
Azoxystrobin***	9.3%
Propiconazole****	11.6%
<b>Other Ingredients:</b>	<b>72.1%</b>
<b>Total:</b>	<b>100.0%</b>



GROUP 3A | 4A | INSECTICIDES

Active Ingredient:	
Lambda-cyhalothrin <sup>1,2</sup>	9.59%
Thiamethoxam <sup>3</sup>	19.20%
<b>Other Ingredients:</b>	<b>71.21%</b>
<b>Total:</b>	<b>100.00%</b>



**ACTIVE INGREDIENT:**

Prothioconazole, 2-[2-(1-Chlorocyclopropyl)-3-(2-chlorophenyl)-2-hydroxypropyl]-1,2-dihydro-3H-1,2,4-triazole-3-thione	14.90%
Trifloxystrobin, (E,E)-alpha-(methoxyimino)-2-[[[1-[3-(trifluoromethyl)phenyl] ethylidene]amino]oxy]methyl]-methyl ester	13.10%
Fluopyram: N-[2-[3-chloro-5-(trifluoromethyl)-2-pyridinyl]ethyl]-2-(trifluoromethyl)benzamide	10.90%
<b>OTHER INGREDIENTS:</b>	<b>61.10%</b>
<b>TOTAL:</b>	<b>100.00%</b>



<b>ACTIVE INGREDIENT:</b> Imidacloprid*	<b>21.0%</b>
β-cyfluthrin**	<b>10.5%</b>
<b>OTHER INGREDIENTS:</b>	<b>68.5%</b>
Contains 2 lbs imidacloprid per gallon plus	<b>TOTAL: 100.0%</b>



Active Ingredients:	
Azoxystrobin	13.5%
Propiconazole	11.7%
<b>Other Ingredients:</b>	<b>74.8%</b>
<b>Total:</b>	<b>100.0%</b>



ACTIVE INGREDIENT:	% BY WT.
Lambda-cyhalothrin; [1a(S*), 3a(Z)]-(±)-cyano-(3 phenoxyphenyl)methyl-3-(2-chloro-3,3,3-trifluoro-1-propenyl)-2,2-dimethylcyclopropanecarboxylate:	12.7%
<b>OTHER INGREDIENTS:</b>	<b>87.3%</b>
<b>TOTAL:</b>	<b>100.0%</b>

## Soybean Foliar Fungicide/ Insecticide Study

**Results:** When comparing the application of standalone fungicide products, all 3 products had a similar yield gain with an average of +7.1 Bu/A. As insecticides were added to the tank mix, an additional yield increase of +1.5 Bu/A. was recorded.

Economics indicate average fungicide treatment gained +\$52.14 over the untreated control, while insecticide treatments gained an average of +\$11.53/A. over standalone fungicide. It is important to note the cost of the fungicide ranged from \$12.31 to 21.35, while the insecticide added additional costs ranging from \$2 to \$7.72.

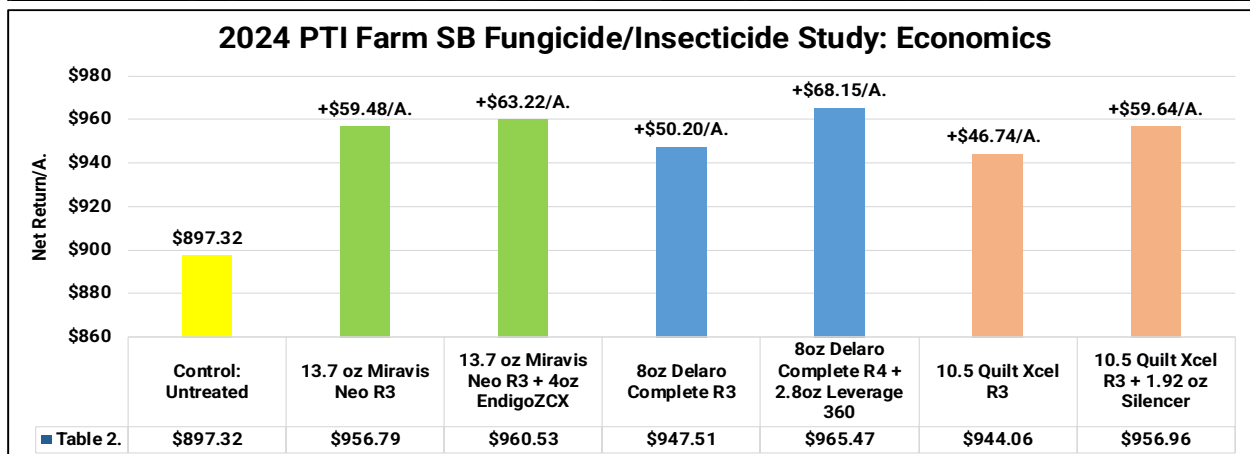
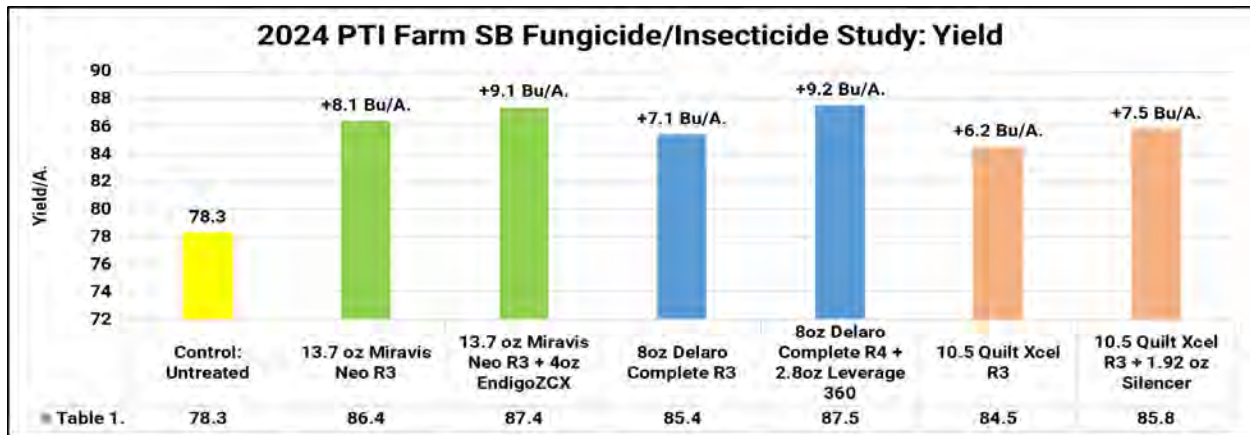

Planting Date: May 18<sup>th</sup> Variety: AG 33XF3 Population: 130K Row Width: 30" Rotation: BAC SB Price: \$11.46 Miravis@Neo™: \$21.35/A. Endigo@ZCX: \$7.72/A.

Delaro@ Complete: \$19.17/A. Leverage@360: \$6.11/A. Quilt Xcel®: \$12.31/A. Silencer® EC: \$2.00/A. App: \$12.00/A.

## Fungicide Ground vs. UAV Foliar Spray Application Study

**Objective:** To evaluate the yield and net return of Trivapro® fungicide applied at R3 growth stage.

This study evaluates a traditional ground fungicide application with a Hagie® high-clearance sprayer, at a carrier rate of 15 Gal/A. Additionally, the use of a DJI™ AGRAS T40 spray UAV was also evaluated at carrier rates of 3 Gal/A. (Figure 1).

Miravis® Neo™ fungicide combines propiconazole, azoxystrobin and Adepidyn technology – one of the most powerful, broad spectrum SDHI molecules available, and delivers superior plant-health benefits and improved preventive and curative control of key such as Brown Spot, Pod and Stem Blight, Frogeye Leaf Spot, Anthracnose, Powdery Mildew and White Mold (suppression).



ADEPIDYN® Technology*	
Active Ingredients:	
Pydiflumetofen**	7.0%
Azoxystrobin***	9.3%
Propiconazole****	11.6%
Other Ingredients:	72.1%
<b>Total:</b>	<b>100.0%</b>

Figure 1. DJI™ AGRAS T40 UAV



## Fungicide Ground vs. UAV Spray Application Study Continued

**Results:** Table 1. illustrates that R3 foliar applications of Miravis®Neo resulted in yield gains of +8.2 to +8.6 Bu/A. The Hagie® high clearance sprayer and the T40 spray UAV offered similar yields, ranging within only 0.4 Bu/A. of each other. This yield gain equated to +\$4.58/A. additional return.

When used properly UAV technology can offer similar or better results than traditional ground application equipment. 2-yr 2023-2024 data has proven a +\$3.60/A. advantage for UAV applications, however a grower would have to evaluate cost of application to determine net economic advantages.

Advantages to UAV technology include precise application due to downward propeller air movement, low carrier rates, the absence of ground or soil engagement, and the ability to spray in fields with topography challenges. Disadvantages include flight time duration, tank capacity, battery charge, and insurance/licensing.

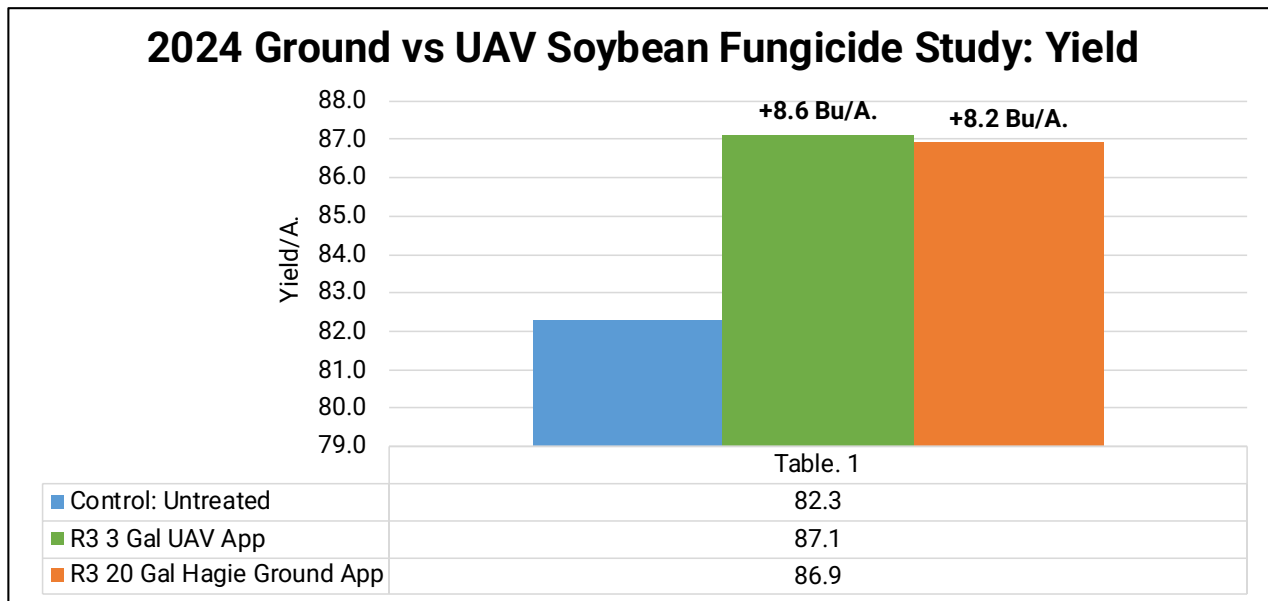

Planting Date: April 24<sup>th</sup>    Variety: Becks 3300E3    Pop: 130K    Row Width: 30"    Rotation: BAC    Soybean Price: \$11.46

Ground Application: Turbo TwinJet Twin Flats 11005, 80# PSI 20 Gal/A.    UAV Application: 3 Gal/A.

## Aqua-Yield® NanoPro® Foliar Fungicide Study

**Objective:** To evaluate yield and economics of NanoPro® by AQUA-YIELD®. NanoPro® is a carrier adjuvant that enhances the uptake of crop protection products.

This trial aims to establish the efficiency of Aqua-Yield's NanoPro® as a tank-mix partner with a corn fungicide applied at the R3 growth stage (13.7oz/A. Miravis® Neo).



**Results:** Table 1. illustrates Aqua-Yield's NanoPro® resulted in +3.3 Bu/A. yield improvement over the control of a standard fungicide application at R3 growth stage.

With a +3.3 Bu/A. yield response, economics would suggest that NanoPro® resulted in positive economic gains of +\$34.91/A.

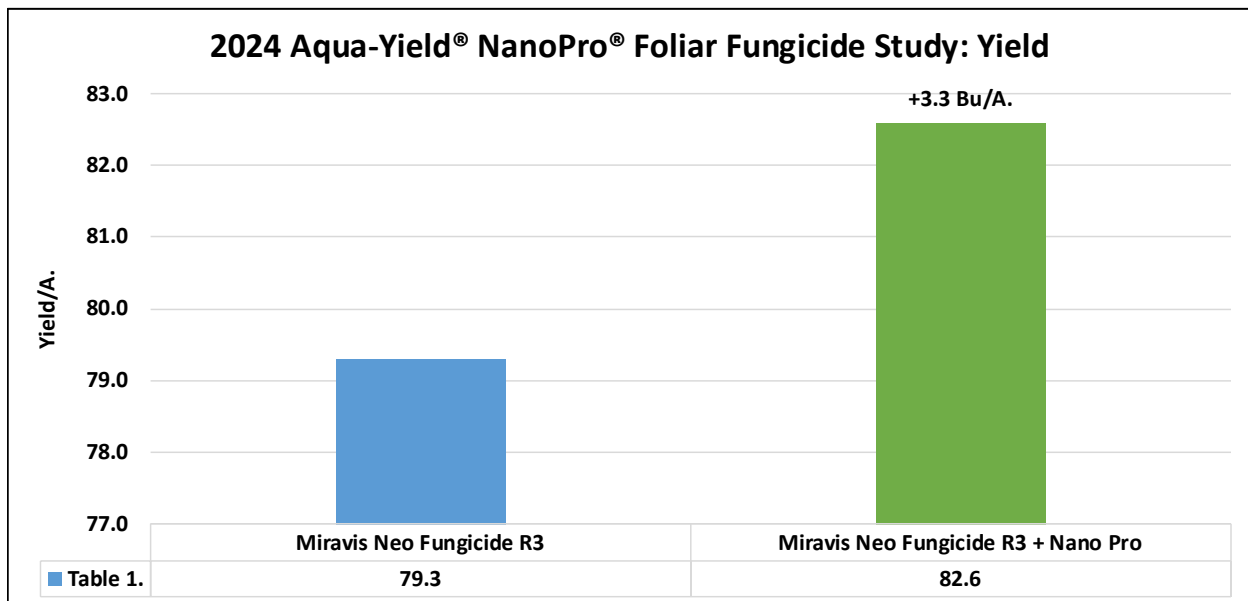

Planting Date: May 11<sup>th</sup>    Variety: AG 27XF3    Population: 130K    Row Width: 30"    Rotation: BAC    Soybean Price: \$11.46    NanoPro®: \$2.91/A.

## Green Lightning™ Plasma Activated Water Soybean Study

**Objective:** To evaluate yield and economics of Green Lightning plasma activated water applied to soybeans. Green Lightning is a mechanism to replicate a naturally occurring process that leads to nitrogen. During a lightning storm, static electricity rearranges the nitrogen molecule in the air, and this modified molecule is contained within the rain. Green Lightning devices create lightning in a controlled environment under the same premise. Air and water are sent into a static electric field for the nitrogen molecule to go through a rearrangement process that allows attachment of the water present, flowing through the machine, and deposits an end product as NO<sub>2</sub> (nitrite) and NO<sub>3</sub> (nitrate).

A six head system called the THUNDER 365, produces nitrogen for 550 acres of corn annually. This system is designed for use by a farmer, in his/her own tool-shed, to make nitrogen by using only a 110v power, grounding rods, and a water supply.

This study compares the use of Green Lightning plasma activated water applied as seven different treatments as follows:

1. 10 Gal/A. at-plant FurrowJet® At-Plant In-Furrow
2. 20 Gal/A. at-plant dual band Conceal®
3. Treatments #1 and #2 Combination
4. 20 Gal/A. R4 Foliar Post Application
5. 20 Gal/A. R1 EZ-Drop Side-Dress
6. Treatments #1, #2, and #4
7. Treatments #1, #2, and #5

Figure 1. Green Lightning Plasma Activated Water Machine



## Green Lightning™ Plasma Activated Water Soybean Study

**Results:** Yield response all treatments averaged only +0.46 Bu/A., along with average economic losses of **-\$3.98/A.** At-plant FurrowJet® and Conceal® treatments resulted in gains of +0.3 Bu/A., with economic gain of +\$2.20/A. R4 foliar and R1 side-dress applications needed additional passes, thus additional equipment expense resulted in net economic losses.

In our 1<sup>st</sup> year of testing this product on soybeans, we are still trying to understand the nuances of this product. The 2024 low yield response may be due to hard water issues (high calcium) and the need for reverse osmosis treated water with creating the plasma activated water with the Green Lightning unit. However, if we could improve performance, this product has tremendous potential. Due to the low cost of creating Green Lightning at only \$0.04/gallon, a 20 Gal/A. treatment giving just a +0.5 Bu/A. soybean yield response correlates to an increase in revenue of +716%. Seeing numbers like this, we look forward to additional testing in 2025.

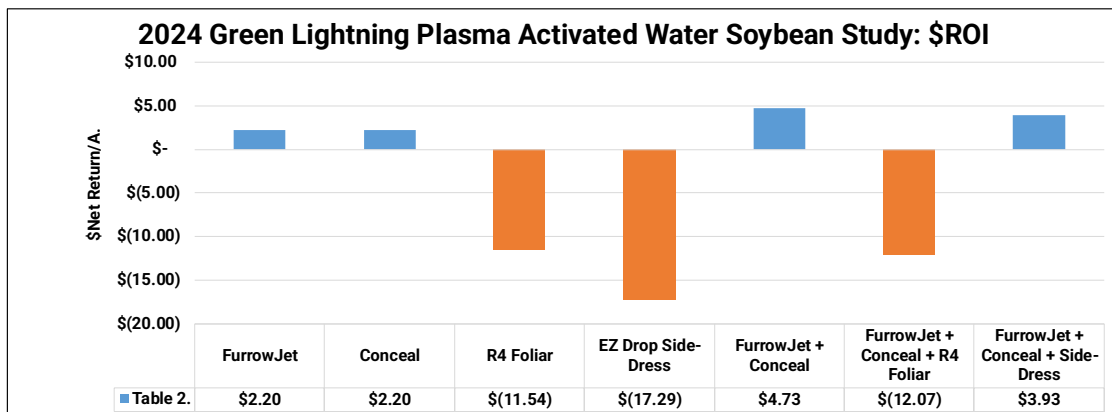
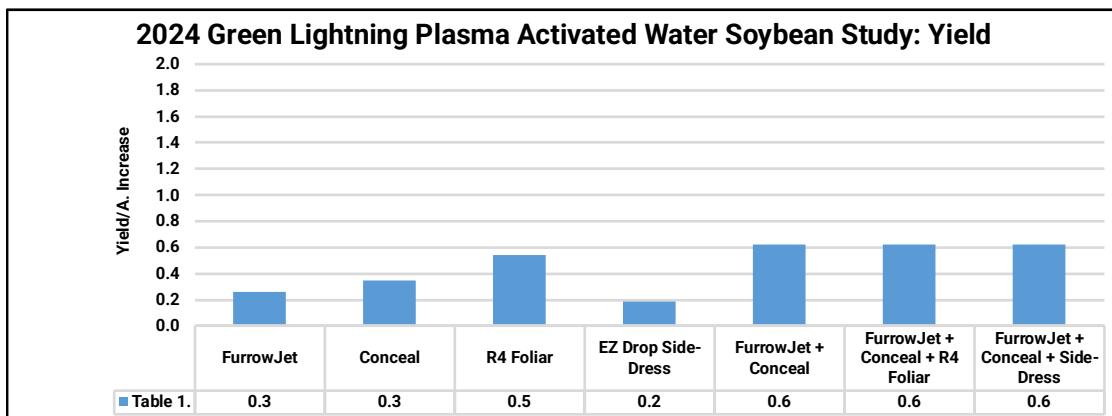

Planting Date: May 16<sup>th</sup> Variety: ProHarvest Apex 3131 Population: 130K Row Width: 30" Rotation: SAC SB Price: \$11.46 Green N: \$0.04/Gal.



## Soybean Tillage Study

**Objective:** To evaluate the yield and economic impacts of various tillage programs in a soybean after corn rotation. Tillage programs include conventional till, strip-till, vertical till, no-till and in-line rip.

Figure 1. KUHN® Krause® Gladiator®



Figure 2. Sunflower® 4630 Disc



## Soybean Tillage Study Continued

Figure 3. Planting in No-Till



Table 1. Univ. of IL Machinery  
 Cost Estimates

Tillage Practice	Category	Cost
Conventional Till	Ripper	\$36.40
	Soil Finisher	\$14.60
	Plant	\$21.40
	Total:	\$72.40
Strip Till	Strip	\$25.90
	Burndown	\$10.00
	Plant	\$21.40
	Total:	\$57.30
Vertical Till	Vertical	\$17.60
	Burndown	\$10.00
	Plant	\$21.40
	Total:	\$49.00
No Till	Plant	\$21.40
	Burndown	\$10.00
	Total:	\$31.40
In-Line Ripper	V-Ripper	\$33.70
	Soil Finisher	\$14.60
	Plant	\$21.40
	Total:	\$69.70

Figure 4. Kuhn® EXCELERATOR® XT 8010 Vertical Tillage



Figure 5. Sunflower® 4608 In-Line Ripper



## Soybean Tillage Study Continued

**Results:** To understand both yield and economics, the University of Illinois Machinery Cost Estimate Summary is used to calculate individual cost of each tillage program (Table 1). For the three reduced tillage programs, an extra \$10/A. burn-down is also included due to higher herbicide costs in 2024.

Table 2. illustrates the overall yield for each tillage segment. The yields varied only 3.0 Bu/A. between all tillage programs with Conventional tillage offering the highest yield of 72.7 Bu/A.

After applying all appropriate costs to each individual tillage segment, Strip- Till offered the highest overall revenue in this tillage system study in 2024. Compared to strip-till, no-till offered losses of **-\$2.52/A.**, conventional tillage **-\$9.60/A.** and vertical tillage with the highest losses of **-20.35/A.** (Table 3.)

Table 4. illustrates multi-year data from the PTI Farm over the time period of 2018-2024. Over this time frame, no-till has provided economic gains of +\$6.81/A. over strip-till, +\$21.39/A. over conventional till and +\$10.11/A. over vertical tillage.

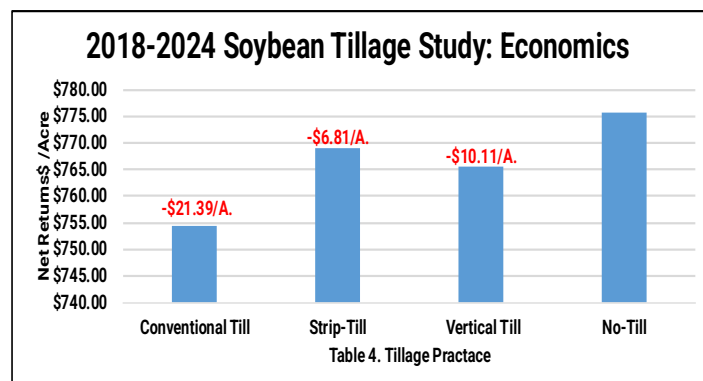
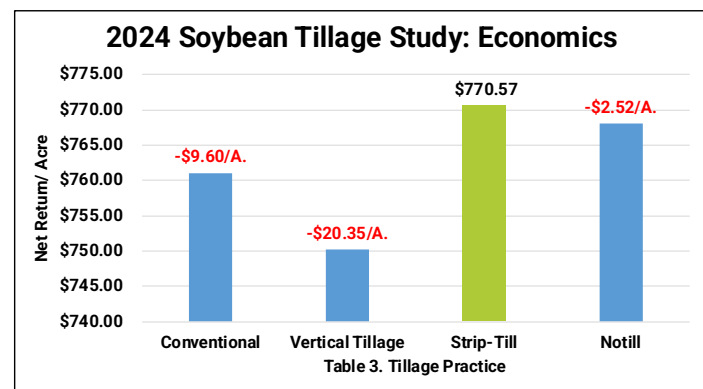
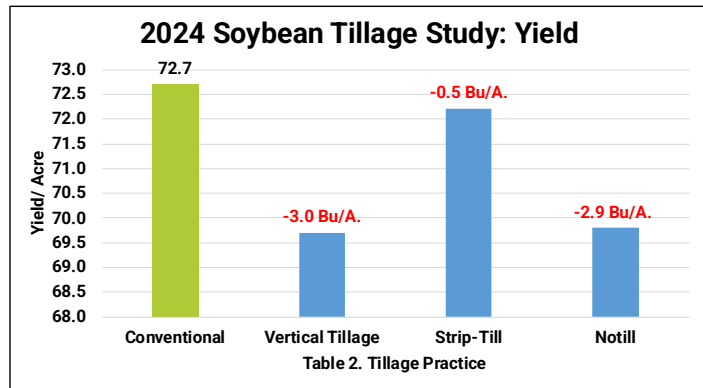

Planting Date: May 5<sup>th</sup> Variety: Asgrow 27XF3 Population: 130K Row Width: 30" Rotation: BAC SB Price: \$11.46 Additional Burndown: \$10/A.

## Soybean Pre-Strip Vertical Tillage Study

**Objective:** To evaluate the yield and economic benefit of implementing a vertical tillage pass (Figure 1.) in corn stalks before a fall strip-till application (Figure 2.) to aid in stalk decomposition.

**Results:** Vertical tillage made pre-strip-till proved to be beneficial with a +0.4 Bu/A. yield contribution. As a result of the extra pass, net economic losses occurred of **-\$13.02/A.**

Tillage Practice	Category	Cost
Conventional Till	Ripper	\$36.40
	Soil Finish	\$14.60
	Plant	\$21.40
Total:		\$72.40
Strip Till	Strip	\$25.90
	Burndown	\$10.00
	Plant	\$21.40
Total:		\$57.30
Vertical Till	Vertical	\$17.60
	Burndown	\$10.00
	Plant	\$21.40
Total:		\$49.00
No Till	Plant	\$21.40
	Burndown	\$10.00
Total:		\$31.40

Figure 1. Kuhn® EXCELERATOR® XT 8010 Vertical Tillage Before Strip-Till



Figure 2. Kuhn® Krause® Gladiator

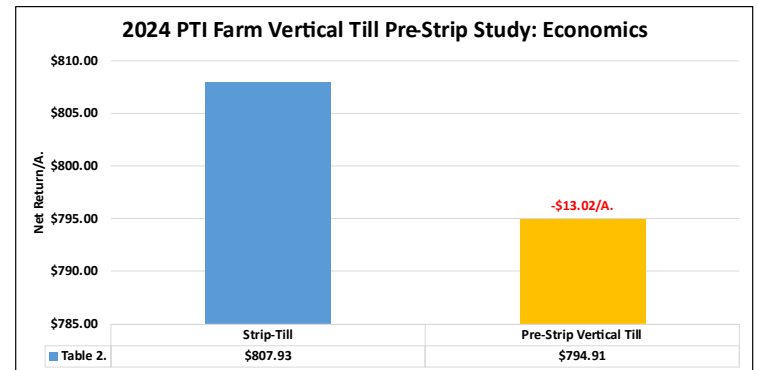
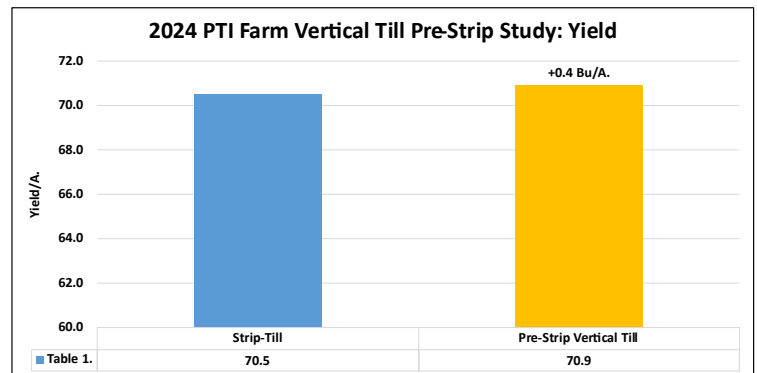

Planting Date: May 15<sup>th</sup> Variety: Asgrow® 27XF1 Population: 130K Row Width: 30" Rotation: BAC Soybean Price: \$11.46

## Soybean Spring Strip-Till Study

**Objective:** To evaluate the yield and economic benefit of implementing a spring strip-till pass in corn stalks. In the past the PTI Farm has been advocates of fall strip-till due to fit conditions at the 6- 8 inch depth the knife runs. With rapidly changing weather conditions last fall the PTI Farm opted to test spring strips compared to the alternative no-till.

**Results:** Spring strip-till proved to be detrimental with a **-2.4 Bu/A.** loss. As a result of the extra pass, net economic losses occurred of **-\$53.12/A.**

Tillage Practice	Category	Cost
Strip-Till	Strip	\$ 25.90
	Burndown	\$ 10.00
	Plant	\$ 21.40
	<b>Total:</b>	<b>\$ 57.30</b>
No-Till	Plant	\$ 21.40
	Burndown	\$ 10.00
	<b>Total:</b>	<b>\$ 31.40</b>

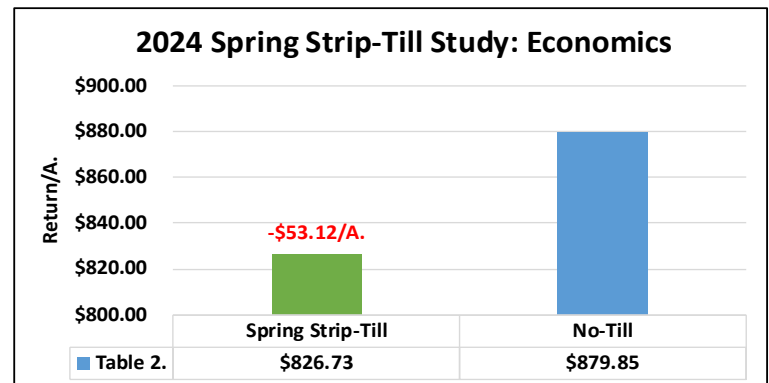
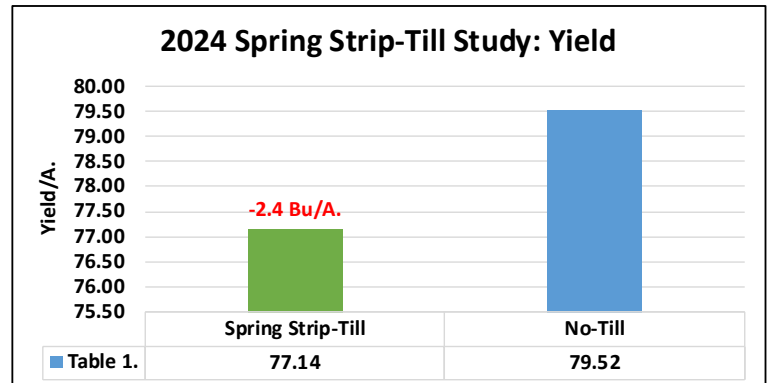

Planting Date: May 15<sup>th</sup>    Variety: Asgrow® 27XF1    Population: 130K    Row Width: 30"    Rotation: BAC    Soybean Price: \$11.46

## Soybean Chopping Corn Head Study

**Objective:** To study the yield impact of utilizing a chopping corn head in a corn/soybean conventional tillage rotation. A Capello DIAMANT™ chopping head is used to create replicated strips of chop and non-chop residue management trials. The goal of this trial is to evaluate sizing of residue, allowing heavy stalks and residue to break down faster to advance the degradation process and in turn, reducing the carbon penalty associated with continuous corn environment.

**Results:** Table 1. illustrates that chopping corn residue improved soybean yields by +1.8 Bu/A. At a soybean commodity price of \$11.46/Bu, this resulted in additional gross revenue of +\$20.63/A.

Multi-year data from 2018-2024 indicates yield advantages of +0.9 to +3.3 Bu/A.

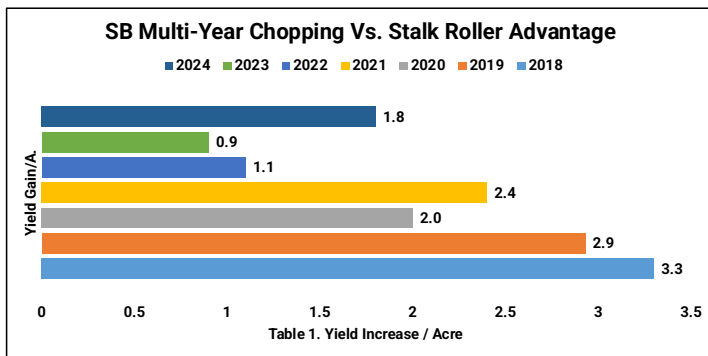

Planting Date: May 15<sup>th</sup>    Variety: Asgrow® 27XF1    Population: 130K    Row Width: 30"    Rotation: BAC    Soybean Price: \$11.46

# WRAP UP



Precision Planting is excited to share our 2024 PTI research farm results and findings. We hope they provide useful insights that help drive thoughtful consideration around future crop management. The PTI Farm is working diligently to continue with long-term studies that provide multi-year data analysis for decision-making purposes.

One of the questions that you may be asking after reviewing the extensive data and results from our 2024 research plots, is why? Why publish over 144 research plots, over 400 acres, with on-farm visits and agronomic discussions. The answer is what it has always been; we must continue to challenge the status quo. We must find better, smarter, and higher return on investment solutions for the growers and their farms. Precision Planting created the Precision Technology Institute to provide a place for growers to meet and learn, while providing results of research plots that illustrate the practical value of their products in real world situations. The research we are sharing is designed by Precision Planting to better understand what solutions, in combination with real-world scenarios, can actually provide both a yield and economic benefit. These are learnings that we will continue to develop, implement, study and share, to provide our growers with the tools to help improve their bottom line.



## VISIT THE FARM

Field days take place each summer giving you an in-person PTI experience.

[precisionplanting.com/pti](https://precisionplanting.com/pti)



## BECOME AN INSIDER

InsidePTI is your chance to hear from the PTI team as they share trial results, agronomy explanations, farm updates, and lessons they've learned sent to your inbox.

[insidepti.com](https://insidepti.com)

## **Acknowledgements and Legal Statement**

vSet®, SmartFirmer®, Keeton®, CleanSweep®, SpeedTube®, DeltaForce®, vDrive®, Clarity™ FurrowJet®, Conceal®, mSet®, 20|20®, SmartDepth®, FurrowForce®, DrySet™ Reveal®, Pump Stack®, EM Flowsense™, EMHD® and WaveVision® are all Trademarks of Precision Planting, LLC. imPulse®, Triple Option®, Face Off®, K-Fuse®, Finish line®, Start2Finish®, bio-K®, Throwback®, MoneyBall®, First Down®, NockOut®, Rhyzo-Link®, K-Flex®, Humi-Flex® FA, Microzone Ca, Crop Max, K-Fuel®, Balance® are trademarks of Nachurs Alpine Solutions. Envirozyme, MycroGold Dust, High Energy Fish Sea Crop, AgroVive Ion FX, Dakota Boss B4, Spectra, Seed Heater, 5-Way Sweetener, Growthful and Microsorb are products of Nutrient Management Specialists LLC. Pro-Germinator®, AccesS™, FertiRain®, Sure-K®, Micro 500®, eNhance™, LibirateCa™, Nresponse®, nanoCOTE™ Kalibrate® are trademarks of AgroLiquid LLC. NutriStart™, Soil Assist, Calcium Plus, MycoBoost, QuickGrow LTE, Poseidon, Energizer, Y-MAXX, Foliar Complete, Iron Plus are all products of Marco N.P.K. Inc. QLF™, Boost™, Amino-15™, Corn Spike, Kelpak, PowerAid, TripleThreatOption 5-5-5, are trademarks of QLF™. REVLIN® HOPPER THROTTLE™ are registered trademarks of Meristem Crop Performance Group LLC. Mosaic®, Nutriform®, Aspire®, and MicroEssentials® SZ® are registered trademarks of The Mosaic Company. Nano-CS™, NanoN+™, Nano-K®, Nano Pro® are trademarks of Aqua Yield operations. PhycoTerra® is a registered trademark of Heliae Development, LLC. Micro Pak, Brix Builder, Humate, and Sea Kelp are products of Pritchard Ag LLC. Fortified Stimulate Yield Enhancer® Plus, Utrisha™N, Harvest Plus™, Sugar Mover®, Harvest More®, Bio-Forge®, X-Cyte™ and Corteva are registered trademarks of Corteva. Upward, Octane™, ArchiTech, XR<sup>2</sup>-KSB are products and trademarks of AgXplore®. SeedRight BundleDrop is a product of Seed Right. Bio-Stealth with Provid-R PM, Phenom®, Growthful™, Frenzy™ are registered trademarks of NewFields Ag™. SpeedWet Xion SiliconGel® is a registered trademark of SpeedAgro. Green Lightning™ and Thunder 365 are registered trademarks of Green Lightning Nitrogen. HydroGel is a product by Green Evolution Technologies. Envita® is a trademark of Engage Agro Corporation. Sea-90™ is a product of Ocean Blue Ag. ProveN®40 and ProvN®40 OS is a trademark of Pivot Bio. NETAFIM™ is a Trademark of Netafim LLC. NutriDrip System is a product from Kurt Grimm. EZ-DROPS™ is a trademark of EZ-Drops. fCrusher is a product from Martin-till®. ESN® is a registered trademark of Nutrien®. APSA-80™ a trademark of Amway™. DJI and AGRAS are trademarks of DJI. GERMINATOR® a product of Farm Shop MFG, LLC. Sunflower®, Fendt®, GSI® and Momentum® are trademarks of AGCO. RoboCrop Guided Row Cultivator is a product of Garford. DIAMANT™ and Quasar® are trademarks of Capello Inc. KUHN®, Krause®, Exceleator®, Gladiator®, and AXIS® are trademarks of KUHN North America Inc. Montag® is a trademark of Montag Mfg. ADI™ is a trademark of Ag Drainage Inc. Twister® and 2984 Strip Freshener are a trademark and a product of YETTER Manufacturing CO., INC. HyperSound Hydro+ 2" Egg and HyperSound Gravity 6" Egg are products of WISE LIFESTYLE. Silencer® 1EC is a registered trademark of ADAMA Essentials. Quiet Dryer® and GSI are trademarks and products of GSI. SIMPAS® is a registered trademark of AMVAC Chemical Corporation. John Deere® and John Deere 1770 Planter are trademarks of Deere & Company. CaseIH and Case 2150S are registered trademarks of CNH Industrial N.V. Hagie® is a trademark of Hagie Manufacturing Company LLC. NutriMax® Single Coulter, NutriMax® Double Coulter, NutriMax® Dual Delivery System, Brent® V1000 Auger Cart, NutriMax® 1400 Side-Dress Applicator are trademarks of Unverferth Manufacturing. Nitrogen Sealing Systems, N-Place™ Max is a product and trademark of Nitrogen Sealing Systems. Veltyma®, Nurizma™, and Revytek® are trademarks of BASF. Miravis® Neo, Miravis®Top, Acuron®, Endigo®ZCX, QuiltXcel® RidomilGold® GR, and Golden Harvest® are all trademarks of Syngenta Corp. SO4™, 98G™, and Calcium Products™ are trademarks of Calcium Products. Capture®, LFR®, Ethos® Elite, Adastrio™, Fmand Xyway®, are trademarks of FMC Agricultural Solutions. Brandt® Auger Cart 820XT is a trademark of Brandt®. RH3330 50' land roller are trademarks and product of Summers Manufacturing, Inc. Case IH® and Early Riser® 2150 are trademarks of CNH Industrial America LLC. Harvest International® Ultra™ Series 40 20" planter is a trademark of Harvest International. HAGIE is a trademark of Hagie Manufacturing Company LLC. Prairie Hybrids Non-GMO and Organic Seed are products of Prairie Hybrids Pioneer® is a Trademark of Pioneer Hi-Bred International Inc. ProHarvest Seeds® is a trademark of ProHarvest Seeds. WYFFELS HYBRIDS® is a registered trademark of Wyffels Hybrids. Channel®, Delaro® Complete, Dekalb® and Asgrow®, Leverage®360, BAYER®, and Preceon™ are registered trademarks of Bayer AG.

The University of Illinois Machinery Cost Estimates provided by The University of Illinois Farm Business.  
The Iowa State University Tillage Rate provided by the Iowa State University Extension and Outreach.